

Preface

Thank you for purchasing EM600 series inverter.

Document No.: 31010064

Issue Date: 2018-07

Version: 103

EM600 is a high-performance vector control inverter series and supports: 3-phase AC induction motor and permanent magnet synchronous motor; multiple internationally leading control technologies, i.e., improved vector control VF technology (VVF), sensorless vector control technology (SVC) and feedback vector control (FVC); speed output and torque output; expansion, i.e., I/O expansion card, communication bus expansion card and multiple PG cards.

Main Features:

- High torque control accuracy: SVC/±8% rated torque, FVC/±5% rated torque;
- Wide speed regulation range and high control accuracy: VF/1:50, SVC/1:200, FVC/1:1000, and ±0.2% rated speed;
- Loading capacity at low frequency: VVF/1 Hz/150%, SVC/0.25 Hz/150% and FVC/0 Hz/150%;
- Multiple types of guarantees: Overvoltage stall, rapid current limit, overload protection, overheating protection, off-load protection, overspeed protection, etc.;
- Support I/O expansion: 4 numeric inputs, 1 numeric output, and one -10V - 10V voltage input;
- Support communication bus expansion and realize various industrial networking: 485 bus, Profibus-DP network, CANopen network and DeviceNet network;
- Support multiple encoders: ABZ Incremental Encoder, UVW Incremental Encoder, UVW Wire-Saving Encoder and Rotary Transformer Encoder.

Please read this manual carefully before using EM600 and keep it properly.

Before connecting EM600 and a motor for the first time, please select a proper type of motor (induction motor or synchronous motor) and configure the motor nameplate parameters including rated power, rated voltage, rated current, rated frequency, rated rotation speed, motor connection, and rated power factor. If inverter is under FVC control, please select a proper PG card and set encoder parameters correctly.

Since SINEE is committed to the development and improvement of products and product documents, this manual will be updated without notice.

Latest updates and additional information are available at www.sineedrive.com.

Safety Information

In this manual, there are two types of safety information.

 **Danger:** The label indicates that a failure to follow instructions may result in serious injury or even death.

 **Caution:** The label indicates that a failure to follow instructions may result in moderate or slight injury and device damage.

Please read this chapter carefully before system installation, debugging and maintenance and always follow safety precautions below during operation. SINEE will not undertake any damage or loss caused by a failure to follow the instructions.

Safety Precautions

Before Installation:

 **Danger**

1. Do not install inverter if its package is wetted or any component is missing or broken.
2. Do not install inverter if the label information on its package is not identical to that on the inverter.

 **Danger**

1. Be careful when carrying or transporting inverter so as to avoid damage!
2. Do not use inverter if it is damaged or any component is missing so as to avoid injury!
3. Do not touch the parts of control system with bare hands so as to avoid ESD!

During Installation:

 **Danger**

1. Installation base shall be metal or other non-flammable material so as to prevent fire risk.
2. Do not unscrew fixing bolts, especially bolts with red mark.

 **Caution**

1. Ensure that no cable strips or screws are dropped into inverter so as to avoid damage to the inverter.
2. Install inverter at a place with less vibration and no direct sunlight.
3. Consider installation space for cooling purpose when inverter is installed in a closed cabinet or space.

Wiring:

 Danger
<ol style="list-style-type: none">1. Wiring must be performed by authorized and qualified personnel so as to avoid unexpected accidents.2. A circuit breaker must be installed between inverter and mains so as to prevent fire risk.3. Ensure that power supply is off before wiring, and ground inverter in accordance with applicable wiring standard so as to avoid electric shock.4. Grounding terminal must be grounded so as to avoid electric shock and fire risk.

 Danger
<ol style="list-style-type: none">1. Never connect input power supply cable to output terminal U, V or W of inverter. Pay attention to terminal symbols and connect to terminals correctly so as to prevent risks of damaging the inverter.2. Be sure that wiring meets EMC requirements and local safety standards. Cables shall be in recommended sizes so as to prevent accident risk.3. Do not connect braking resistor to DC bus terminals + and – so as to prevent fire risk.4. Tighten terminals with a screwdriver of specified torque so as to prevent fire risk.5. Do not connect a phase-shifting capacitor or an LC/RC noise filter to output circuits.6. Do not connect a solenoid switch or an electromagnetic contactor to output circuits. Otherwise, it will trigger the action of overcurrent protection circuit or even damage the internal parts of inverter.7. Do not disassemble internal cable of inverter. Otherwise, this may possibly damage the internal parts of inverter.

Before Power-on:

 Caution
<ol style="list-style-type: none">1. Verify that input voltage is identical to rated voltage of inverter, input terminals R, S and T and output terminals U, V and W are correctly connected, there are no short circuit phenomena for the wiring of inverter and its peripheral circuits, and all wires are in good connection. Otherwise, this may result in inverter damage.2. Never perform the voltage withstanding test on inverter, because it has been done at the factory. Otherwise, this may result in accident.

 Danger
<ol style="list-style-type: none">1. The front cover of inverter must be closed before the inverter is powered on. Otherwise, it may result in an electric shock.2. Wiring of all peripherals must be conducted in accordance with the guide of this manual. Otherwise, it may result in an electric hazard.

After Power-on

 Danger
<ol style="list-style-type: none">1. Do not touch inverter or its peripheral circuits with wet hands to avoid the electric shock.2. If indicator is off or keypad does not display any information after power-on, please cut off power supply immediately. Never touch any terminal of R, S or T of inverter or

 **Danger**

connecting terminals with hands or a screw driver; otherwise an electric shock accident may occur. Contact our customer service personnel immediately after cutting off the power.

3. After being powered on, inverter will automatically check the safety of the external strong circuit automatically. Therefore, do not touch wiring terminal U, V or W of inverter or wiring terminal of motor with bare hands, otherwise it will result in electric shock.

 **Danger**

1. If you need to check parameter settings, be careful of personal safety when motor is running so as to avoid accidents.
2. Do not change any default parameter setting without approval to avoid damage.

During Operation:

 **Danger**

1. Never touch cooling fan, heat sink or discharge resistor with bare hands for checking temperature, which may result in burning!
2. Only qualified technicians are allowed to detect signal during operation so as to prevent personal injury or device damage.

 **Caution**

1. Prevent any foreign items from being dropped into the device during operation, so as to avoid damage to the device.
2. Do not control the start/stop of inverter by ON/OFF of contactor so as to avoid damage to the device.

Maintenance

 **Danger**

1. Maintain and inspect the device only after inverter is powered off to avoid an electric shock.
2. Maintain and inspect inverter only after its main circuit is powered off and the CHARGE indicator is off. Otherwise, residual electric charge of capacitor may result in personal injury.
3. Maintenance and inspection can be performed by well-trained technicians only, so as to avoid personal injury.
4. Parameter setting is required if inverter has been replaced. Plug-in & plug-out shall be performed after power-off.

Attentions

Motor Insulation Inspection

Motor insulation inspection shall be performed before it is put to use for the first time, put to use after it is left unused for some time or during routine inspection, in order to avoid damaging inverter due to disabled insulation performance of motor winding. Make sure to disconnect motor cable from inverter during inspection; 500V megohmmeter is recommended. Obtained insulation resistance shall not be lower than 5MΩ.

Motor Thermal Protection

If a selected motor does not match with inverter in rated capacity, especially when rated power of motor is lower than that of inverter, be sure to adjust motor protection parameters of inverter or install a thermal relay in front of motor to protect it.

Operation Over Grid Frequency

Output frequency of inverter ranges from 0.00 Hz to 600.00 Hz. To use inverter at over 50.00 Hz, please consider the bearing capacity of mechanical device.

Motor Heat and Noise

Output voltage of inverter presents a PWM waveform along with some harmonic waves, so motor temperature rise, noise and vibration would increase a little in comparison with running under grid frequency.

Varistor or Power Factor Improvement Capacitor on Inverter Output

Inverter outputs PWM wave. Do not use inverter, if a power factor improvement capacitor or a lightning varistor is on output side, which may easily result in transient overcurrent of inverter, or even damage inverter.

Beyond Rated Voltage

Do not use EM600 inverter outside the operating voltage specified in this manual, which may easily damage its internal parts. If you have to do so, install a voltage rise or reduction device for transformation.

Surge Protection

A surge protection device is available in EM600 to prevent it from induction lightning stroke on a certain degree. Additional protection devices are required at the front end of inverter in the places where thunder and lightning are frequently seen.

Altitude and Derating

When inverter is used in an area at an altitude of over 1,000 m, the cooling effect will degrade, so it must be derated. For details, please consult SINEE.

Attentions at Inverter Scrapping

Burning electrolytic capacitors of mains and PCB may result in explosion and burning plastic parts may generate toxic gas. Please handle them as industrial wastes when inverter is scrapped.

Contents

Preface	1
Safety Precautions	2
Attentions	5
1 Overview	9
1.1 EM600 Model List and Technical Specifications	9
1.2 EM600 Operation Status.....	11
1.3 Description of Parts of EM600 Inverter.....	15
2 Installation	17
2.1 Product Verification	17
2.2 Overall and Installation Dimensions.....	18
2.3 Considerations for Installation Site.....	21
2.4 Installation Direction and Space	22
2.5 Assembly and Disassembly of Keypad	22
2.6 Flush Mounting.....	23
3 Wiring	27
3.1 Connection to Peripherals.....	27
3.2 Wiring Main Circuit Terminals.....	28
3.3 Wiring Control Circuit Terminals	37
3.4 Extending Keypad Wire.....	44
3.5 Wiring Verification	45
4 Keypad Operation	46
4.1 Keypad Function.....	46
4.2 LED Keypad Operation Mode	47
4.3 Fault Monitoring.....	51
4.4 Operation Monitoring	51
4.5 Parameter Copy	51
4.6 Function of 	52
4.7 Run/Stop	52
5 Trial Operation	53
5.1 Trial Operation Procedure	53
5.2 Attentions for Trial Operation	55
6 Function Code Table	56
6.1 Parameter Description	56
6.2 Function Parameter Table	57
7 Parameter Description	118
7.1 F00 Group: General Parameter	118

7.2	F01 Group: Motor 1 Parameter.....	132
7.3	F02 Group: Input Terminal Parameter	138
7.4	F03 Group: Output Terminal Function Parameter	150
7.5	F04 Group: Start/Stop Control Parameter.....	157
7.6	F05 Group: VF Control Parameter	163
7.7	F06 Group: Vector Control Parameter	167
7.8	F07 Group: Fault Protection Parameter	173
7.9	F08 Group: Preset Speed and Simple PLC Parameter.....	178
7.10	F09 Group: PID Function Parameter	185
7.11	F10 Group: Communication Function Parameter.....	193
7.12	F11 Group: User-Defined Parameter	200
7.13	F12 Group: Keypad and Display Parameter	202
7.14	F13 Group: Torque Control Parameter	208
7.15	F14 Group: Motor 2 Parameter.....	212
7.16	F15 Group: Auxiliary Function	212
7.17	F16 Group: User Defined Function Parameter	221
7.18	F17 Group: Virtual I/O Function Parameter	224
7.19	F18 Group: Monitoring Parameter	227
7.20	F19 Group: Fault Record Parameter	232
8	Motor Parameter Autotuning.....	234
8.1	Motor Parameter Autotuning.....	234
8.2	Precautions Before Autotuning.....	234
8.3	Steps of Autotuning	235
9	Troubleshooting	236
9.1	Faults	236
10	Maintenance and Inspection.....	243
10.1	Routine Maintenance and Inspection of Inverter.....	243
10.2	Warranty Instruction for Inverter	244
11	Options	245
11.1	Braking Resistor	245
11.2	Braking Unit	246
11.3	Options of Cable.....	246
11.4	Option Card	247
11.5	Base	248
11.6	11.6 Upper Mounting Hole.....	250
11.7	Copper Row for Incoming and Outgoing Cable Switchover	250
11.8	LCD keypad.....	251
12	MODBUS Communication Protocol.....	252
12.1	Application Scope.....	252
12.2	Physical Interface	252

12.3	Protocol Format	252
12.4	Protocol Description	267
12.5	Example	269
13	660V inverter Commissioning Instructions	273
13.1	Wiring	273
13.2	Power on	273
Appendix I	Multi-Functional IO Expansion Card (EC-IO-A1)	275
I.1	General	275
I.2	Installation Instructions	275
I.3	Expansion Terminal Function	276
Appendix II	General Encoder Expansion Card (PG Card).....	278
II.1	General	278
II.2	Installation Instructions	278
II.3	Definition and Instruction of Specification and Wiring Terminal Signal 279	
II.4	Switchs for Frequency Dividing	281
Appendix III	Profibus-DP Expansion Card (EC-CM-P1)	283
III.1	General	283
III.2	Installation Instructions	283
III.3	Expansion Terminal Function	284
Appendix IV	CANopen Expansion Card (EC-CM-C1)	286
IV.1	General	286
IV.2	Installation Instructions	286
IV.3	Expansion Terminal Function	287
Appendix V	DeviceNet Expansion Card (EC-CM-D1).....	288
V.1	General	288
V.2	Installation Instructions	288
V.3	Expansion Terminal Function	289

1 Overview

1.1 EM600 Model List and Technical Specifications

- Rated voltage: 3-phase, 380 – 415 VAC;
- Applicable motor: 3-phase AC induction motor, power range: 0.75 – 400 kW
- Maximum output voltage is identical to input voltage.

EM600 model and rated output current are shown in Table 1–1.

Table1–1 EM600 Model List

Rated Voltage	Model	Motor Power (kW)	Rated Output Current (A)
3-phase, 380 – 415 VAC	EM600-0R7-3B	0.75	2.5
	EM600-1R5-3B	1.5	4.2
	EM600-2R2-3B	2.2	5.6
	EM600-4R0-3B	4.0	9.4
	EM600-5R5-3B	5.5	13
	EM600-7R5-3B	7.5	17
	EM600-011-3B	11	25
	EM600-015-3B	15	32
	EM600-018-3B	18.5	38
	EM600-022-3/3B	22	45
	EM600-030-3/3B	30	60
	EM600-037-3/3B	37	75
	EM600-045-3/3B	45	90
	EM600-055-3/3B	55	110
	EM600-075-3/3B	75	150
	EM600-090-3	90	176
	EM600-110-3	110	210
	EM600-132-3	132	253
	EM600-160-3	160	304
	EM600-185-3	185	357
	EM600-200-3	200	380
	EM600-220-3	220	426
	EM600-250-3	250	465
	EM600-280-3	280	520
EM600-315-3	315	585	
EM600-355-3	355	650	
EM600-400-3	400	725	
EM600-450-3	450	820	
EM600-500-3	500	900	
EM600-560-3	560	1010	
3-phase, 660 – 690 VAC	EM600-160-6	160	175
	EM600-185-6	185	198
	EM600-200-6	200	221
	EM600-220-6	220	235

★: The difference between inverter and motor shall not be more than two power ratings. Please try to select a motor that matches with the inverter in rated current.

EM600 technical specifications are shown in Table 1–2.

Table 1–2 EM600 Technical Specifications

Items		Specifications
Input	Input Voltage Range	3-phase 380 V-20% - 415 V+20%, 50-60 Hz±5%. 3-phase 660 V-15% -690 V+10%, 50-60 Hz±5%. voltage imbalance rate <3%
Output	Maximum Output Voltage	Maximum output voltage is identical to input voltage.
	Rated Output Current	100% non-stop rated current output
	Maximum Overload Current	150% rated current for 60s, 180% rated current for 10s and 200% rated current for 2s
Basic Control Functions	Control Mode	V/F Control (VVF); Sensorless Vector Control (SVC) Feedback Vector Control (FVC)
	Input Mode	Frequency (speed) input and torque input
	Start/Stop Control Mode	Keypad, control terminals (2-wire sequence and 3-wire sequence) and communication
	Frequency Control Range	0.00 - 600.00 Hz
	Input Frequency Resolution	Numeric input: 0.01 Hz, analog input: 0.1% of maximum frequency
	Governor Deflection	1:50 (VVF), 1:200 (SVC) and 1:1000 (FVC)
	Speed Control Accuracy	±0.2% rated synchronous speed
	Acceleration/Deceleration Time	0.01 - 600.00 seconds/0.1 - 6000.0 seconds/1 - 60000 seconds
	V/F Features	Rated output voltage: 20% - 100% adjustable; frequency base: 20 Hz - 600 Hz adjustable
	Torque Boost	Fixed torque boost curve, user defined V/F curve scaling
	Start Torque	150%/1 Hz (VVF), 150%/0.25 Hz (SVC) and 150%/0 Hz (FVC)
	Torque Control Accuracy	±8% rated torque (SVC), ±5% rated torque (FVC)
	AVR	Input voltage changes, but output voltage remains unchanged basically
	Automatic Current Limit	Automatically limit output current to avoid frequently overcurrent trip
Function of Input and Output	DC Brake	Brake frequency: 0.01 - Maximum frequency, brake time: 0 – 30 S Brake current: 0% - 100% rated current
	Signal Input Source	Communication, preset speed, analog quantity, high-speed pulse, etc.
	Reference Power Supply	10 V/20 mA
Output	Terminal Control Power Supply	24 V/200 mA
	Numeric Input Terminal	7 (standard X1 – X7) + 4 (expansion card X8 - X11) numeric

Items		Specifications
		multi-function inputs: X7 can be selected as a high-speed pulse input terminal (F02.06=35/38/40); 10 numeric input terminals, X1 - X6 and X8 - X11, can be only used as common numeric input terminals.
	Analog Input Terminal	3 (standard AI1 - AI3) analog inputs + 1 (expansion card AI4) analog input: 1 (AI1) voltage input (0 - 10 V); 2 (AI2/AI3) voltage inputs (0 - 10 V) or current inputs (0 - 20 mA); 1 (AI4) voltage input (-10V - 10V).
	Numeric Output Terminal	2 (standard Y1/Y2) + 1 (expansion card Y3) OC multi-function outputs and 2 (R1: EA/EB/EC, R2: RA/RB/RC) relay multi-function outputs. Maximum output current of OC: 50 mA; relay contactor capacity: 250 VAC/3 A or 30 VDC/1 A. When relay works, EA-EC and RA-RC are on, but EB-EC and RB-RC are off.
	Analog Output Terminal	2 multi-functional analog output terminals (M1/M2) are with output 0 - 10 V or 0 - 20 mA.
Keypad Display	LED	LED displays relevant information about inverter.
	Parameter Copy	Upload and download parameter setting information of inverter to realize rapid copy.
Protection	Protection	Short circuit, overcurrent, overvoltage, undervoltage, phase loss, overload, overheating, overspeed, offload, external fault, etc.
Working Condition	Installation Site	To be installed indoor with an altitude of less than 1,000 meters, free from dust, corrosive gas and direct sunlight.
	Ambient Temperature	-10℃ - +40℃, 20% - 90% RH (no condensation)
	Vibration	< 0.5 g
	Storage Temperature	-25℃ - +65℃
	Installation Method	Wall mounting, floor mounting (electrical cabinet) and flush mounting
	Protection Grade	IP20/IP21 (450Kw and above)
	Cooling Method	Forced air cooling

1.2 EM600 Operation Status

1.2.1 Operating Status of Inverter

EM600 inverter operating status: Parameter setting, normal running, JOG running, autotuning, stop, JOG stop and fault.

- **Parameter setting status:** After it is powered on and initialized and is standby without a fault or a start-up command, inverter has no output.
- **Normal running status:** Having received an active start command through keypad, control terminal or communication, inverter drives motor as per setting input.
- **JOG running status:** Drives motor at JOG input speed through setting of keypad,

external terminal or communication.

- **Autotuning status:** Set through keypad to autotune parameters of motor in stationary or rotational autotuning.
- **Stop status:** When running command is inactive, output frequency drops to zero as per set deceleration time.
- **JOG stop status:** When JOG running command is inactive, output frequency drops to zero as per JOG deceleration time.
- **Fault status:** Refer to status of inverter at all kinds of faults.

1.2.2 Control Modes of Inverter

Control modes of inverter refer to what kind of open loop or closed loop method is adopted to drive motor at desired speed or torque. These modes include:

- **General open loop space vector control – V/F control:** Suitable for low speed change and low speed stability accuracy and meet the needs of most AC motor drives.
- **Sensorless vector control (SVC):** Advanced speed estimation method, no encoder required, closed loop vector control and high control accuracy.
- **Feedback Vector Control (FVC):** Speed and current are under real-time closed-loop control with high stability speed accuracy and high dynamic response. An encoder must be added under this control mode.

1.2.3 Setting Modes of inverter

Setting mode of inverter refers to what kind of physical quantity is taken as the control object when inverter drives a motor.

- **Speed setting mode:** Motor speed is taken as the control object;

Can be realized by numeric setting, analog quantity input setting, high-speed pulse input setting, communication setting, process PID, simple PLC or preset speed, individually or jointly. In Figure 1-1 to Figure 1-4, various input modes under speed setting mode of EM600 are described:

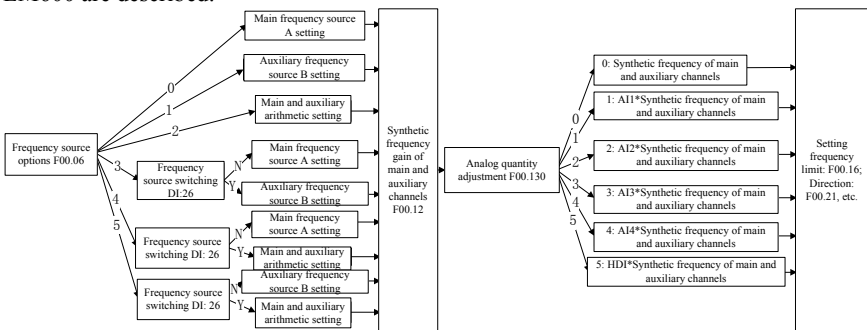

Figure 1-1 Speed Input Mode

As indicated in Figure 1-1, there are three speed setting modes of EM600, respectively main frequency source A setting (referred to “Main A” for short), auxiliary frequency source B setting (referred to “Auxiliary B” for short) and main & auxiliary arithmetic setting. Speed setting mode is finalized by simple regulation and limit (upper limit frequency limit, maximum frequency limit, direction limit, frequency hopping limit, etc.). Setting descriptions are given in Figure 1-2 to Figure 1-4.

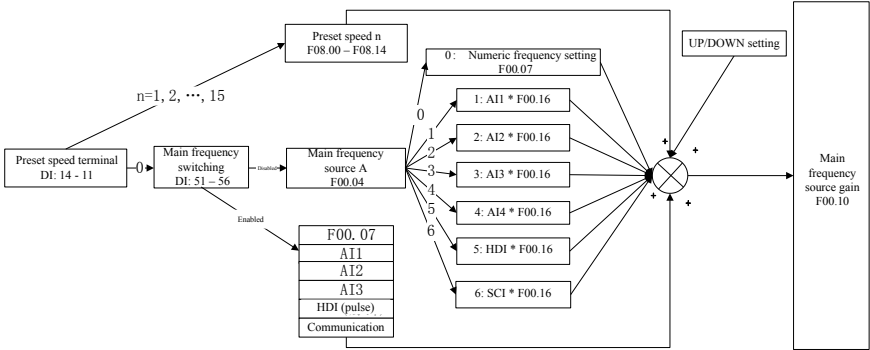

Figure 1-2 Main Frequency Source A Setting

As indicated in Figure 1-2, when setting main frequency source A, user needs to consider settings and status of numeric terminals comprehensively. According to terminal settings, inverter runs at a preset speed or at a speed determined through numeric setting, analog quantity, pulse or communication. If all the terminals are disabled, F00.04 is used to set present setting channel, which then will be in arithmetic together with UP/DOWN to get final setting.

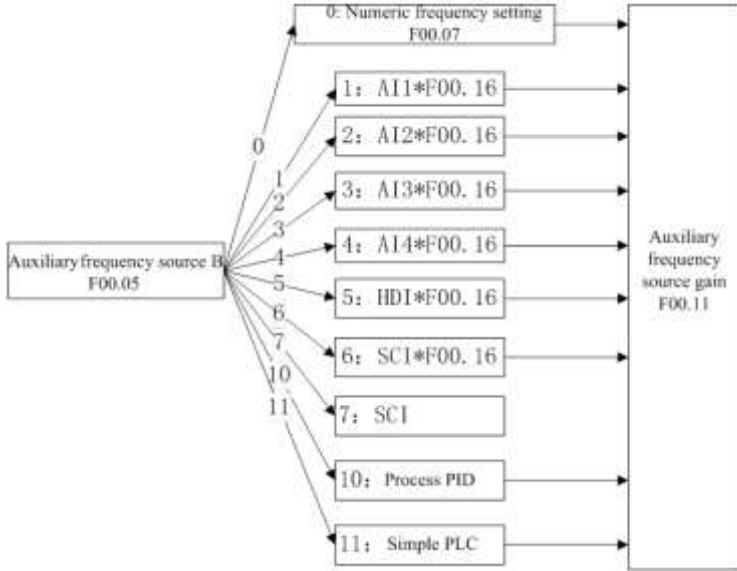

Figure 1-3 Auxiliary Frequency Source B Setting

As indicated in Figure 1-3, when auxiliary frequency source B is being set, setting of F00.05 will be based upon to determine present setting channel. Process PID and Simple PLC can be involved in setting.

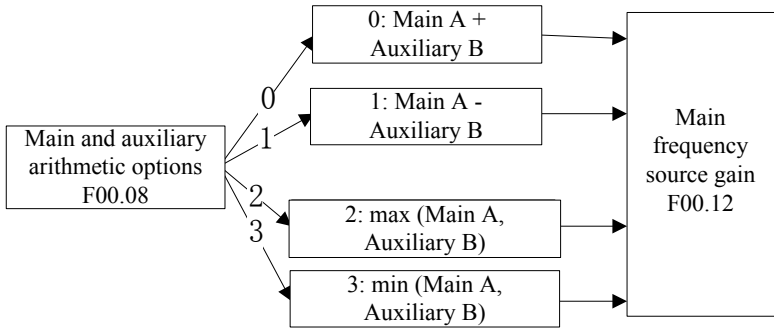

Figure 1-4 Main and Auxiliary Arithmetic Setting

As indicated in Figure 1-4, main and auxiliary arithmetic can be classified into four types. At this time, both main and auxiliary settings are enabled.

- Torque setting mode: Motor current is taken as the control object.

Torque setting mode can be set by multiple ways, which include numeric setting, analog quantity input setting, high-speed pulse input setting, communication setting and preset torque setting. In Figure 1-5, various input modes for torque setting of EM600 are described.

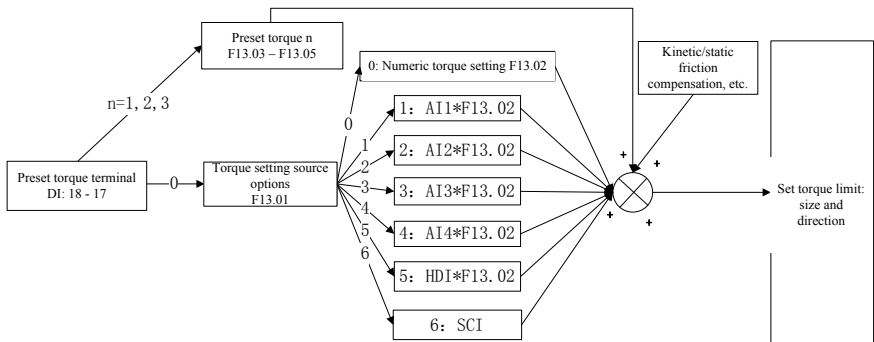

Figure 1-5 Torque Setting Mode

★: JOG speed setting is superior to other settings, i.e., when pressing **M.K** on keypad or enabling control terminals FJOG/RJOG, inverter will automatically switch to jog speed setting, no matter what present setting mode is.

1.2.4 Control Modes of inverter

Control modes of inverter refer to the modes to start/stop inverter. There are three control modes, namely keypad control mode, terminal control mode and communication control mode. Terminal control mode includes 2-wire sequence (RUN and F/R) and 3-wire sequence (RUN, F/R and Xi (i=1 - 7), Xi needs to be redefined as 3-wire start/stop control). Its running mode control logic is shown in Figure 1-6.

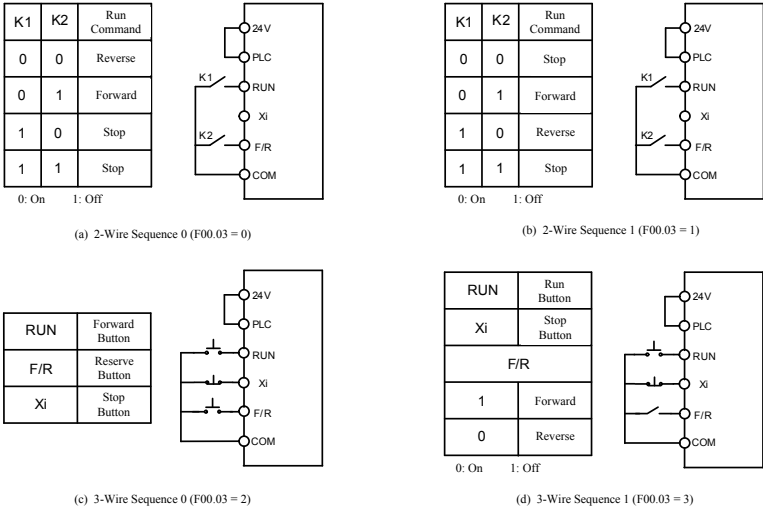

Figure 1-6 Control Logic of Terminal Control Mode

1.3 Description of Parts of EM600 Inverter

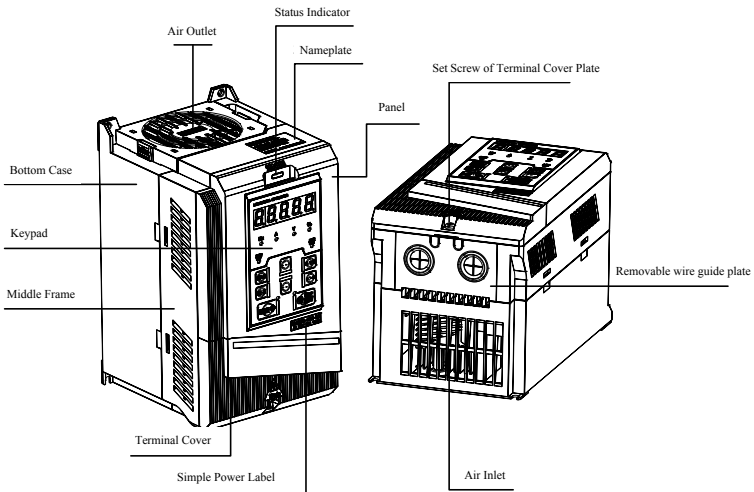

Figure 1-7 Description of Parts of EM600 Inverter (4 kW)

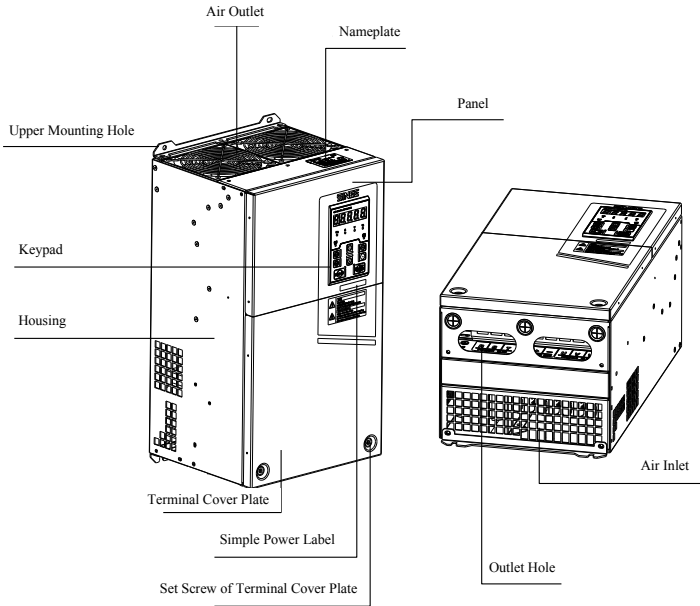

Figure 1-8 Description of Parts of EM600 Inverter (30 kW)

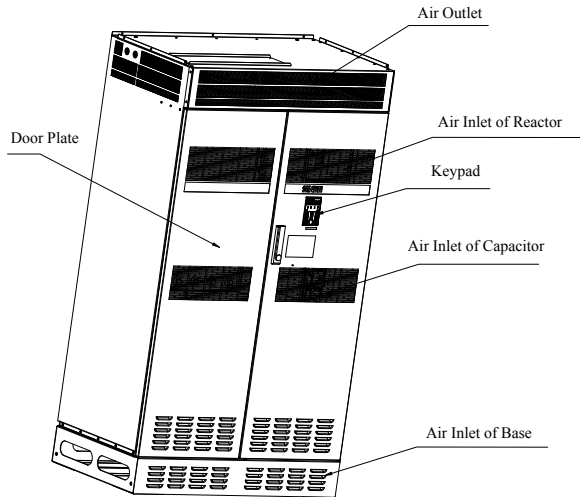



Figure 1-9 Description of Parts of EM600 Inverter (450kW)

2 Installation

2.1 Product Verification

 Caution
<ul style="list-style-type: none"> ● Do not install inverter if it is damaged or any component is missing so as to avoid injury!

Please verify inverter products as per Table 2–1 when you get them.

Table 2–1 Check List

Item	Method
Check if they are identical to purchase order.	Check nameplate at the side of inverter.
Any damage	Check overall appearance to see if any damage has occurred in transportation.
Any loosened screws or other fastening parts.	Check with a screwdriver if necessary.

If you find any quality problem, please contact SINEE Direct Sale Department or the distributor.

- **Nameplate**

SINEE

Model No.: EMXXX-4R0-3B

Rated Power: 4.0 kW Rated Current: 9.4 A

Input: AC 3PH 380-415 V 50/60 HZ

Output: AC 3PH 0-415 V 0/600 HZ



01181120111305030001 AXXXBXXX

Shenzhen Sine Electric Co., Ltd.

3PH AC 380-415V 4.0kW 9.4A

EMXXX-4R0-3B SIN:01181120111305030001 AXXXBXXX

- **Model Numbering Description**

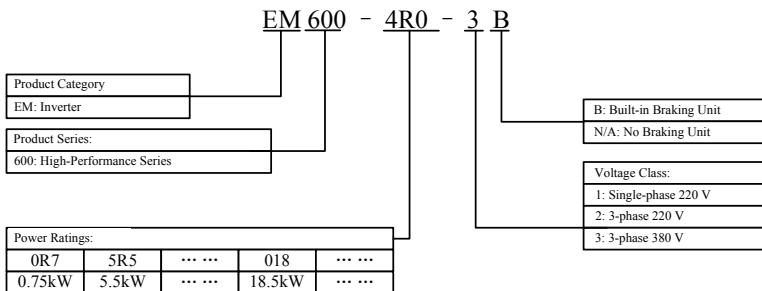

2.2 Overall and Installation Dimensions

EM600 inverters can be categorized into 34 specifications for 4 overall dimensions and 12 installation dimensions (see Figure 2-1 and Table 2-2).

Keypad can be installed onto iron panel separately with hole size of 114.5 ± 0.1 (L) * 71 ± 0.1 (W) mm and metal panel thickness of 1.2 - 2.0 mm.

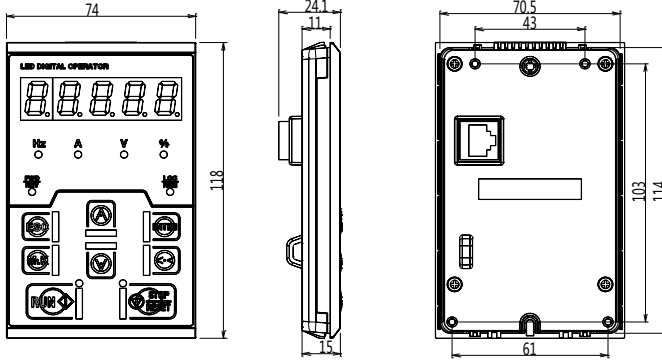

(a) Keypad Dimension

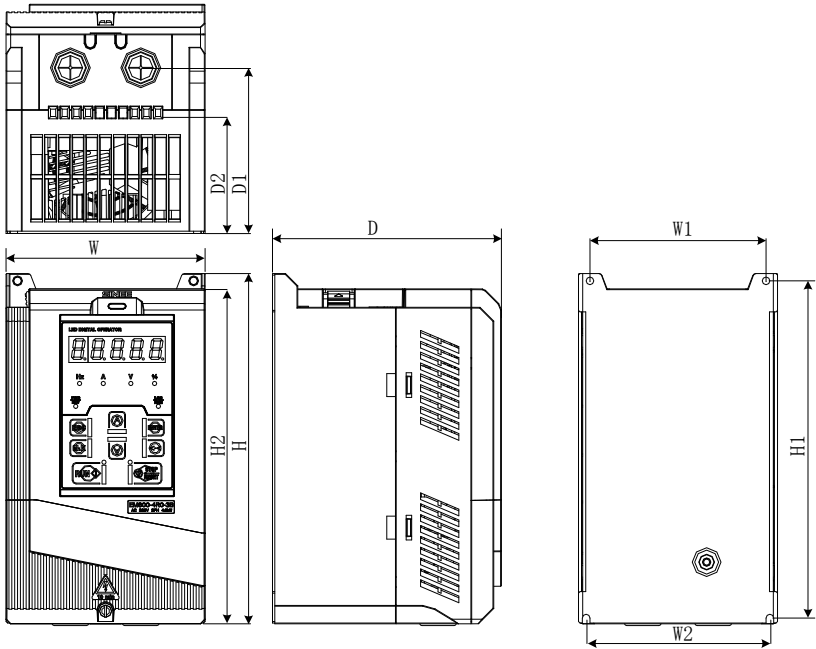

(b) Overall Dimensions of 0.75 kW – 18 kW Inverters

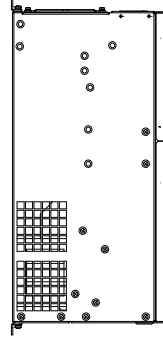
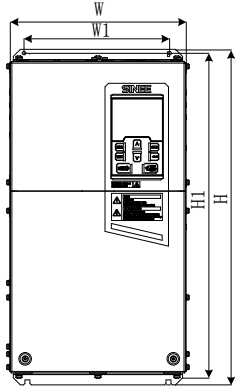
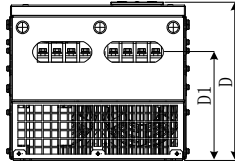

(c) Overall Dimensions of 22 kW – 75 kW Inverters

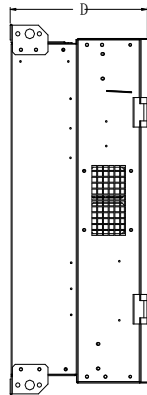
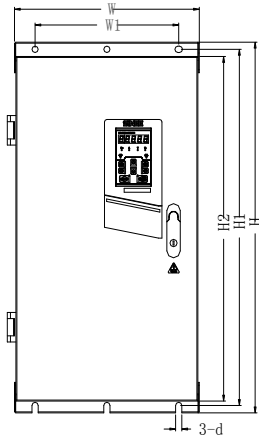
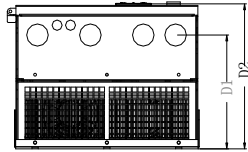

(d) Overall Dimensions of 90 kW – 400 kW Inverters

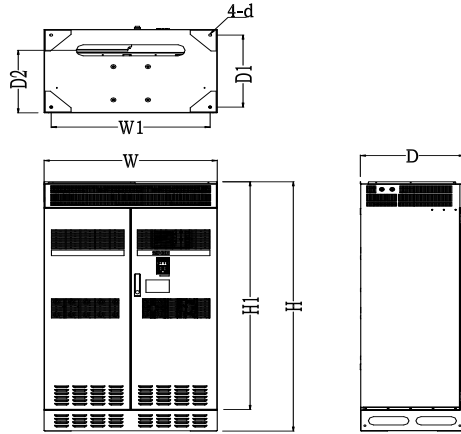

(e) 450~560kW 变频器外形

Figure 2-1 Overall Dimensions of EM600 Inverter and Keypad

Table 2-2 Overall and Installation Dimensions of EM600 Inverter

Model No.	W	W1/W2	H	H1	H2	D	D1	D2	d	Frame
EM600-0R7-3B	130	115/120	228	220	219	153	108	75	5	(b)
EM600-1R5-3B										
EM600-2R2-3B										
EM600-4R0-3B										
EM600-5R5-3B	140	130	270	261	258	172	128	94	5	(b)
EM600-7R5-3B										
EM600-011-3B	180	150	368	353	343	210	165	136	7	(b)
EM600-015-3B										
EM600-018-3B										
EM600-022-3/3B	250	200	484	470	440	222	150	--	6.5	(c)
EM600-030-3/3B										
EM600-037-3/3B										
EM600-045-3/3B	315	200	560	546	513	250	180	--	7	(c)
EM600-055-3/3B	350	250	662	638	603	262	188	--	12	(c)
EM600-075-3/3B										
EM600-090-3	386	300	753	724	700	292	231	300	13	(d)
EM600-110-3	416	300	855	825	793	307	246	315	13	(d)
EM600-132-3										
EM600-160-3										
EM600-185-3	497	397	1107	1076	1036	340	285	348	13	(d)
EM600-200-3										
EM600-220-3										
EM600-250-3	656	450	1348	1314	1261	388	232	395	13	(d)
EM600-280-3										

Model No.	W	W1/W2	H	H1	H2	D	D1	D2	d	Frame
EM600-315-3	801	680	1417	1383	1330	388	190	395	13	(d)
EM600-355-3										
EM600-400-3										
EM600-450-3	1000	920	1800	1645	--	600	520	450	17	(e)
EM600-500-3										
EM600-560-3										
EM600-160-6	497	397	1107	1076	1036	340	285	348	13	(d)
EM600-185-6										
EM600-200-6										
EM600-220-6										

2.3 Considerations for Installation Site

 Caution
<ol style="list-style-type: none"> 3. When carrying and transporting inverter, please hold its bottom. Only taking face panel would result in the risk of hitting your foot due to its dropping. 4. Please install inverter onto a metal panel or other non-flammable material panel. Installing it onto flammable materials may result in fire risk. 5. When at least two inverters are installed in the same control cabinet, please set cooling fan and maintain the air temperature of air inlet below 40°C. Overheating would result in a fire or other accidents.

2.3.1 Installation Site

Installation site shall be maintained to the following conditions:

1. Well-ventilated indoor place.
2. Ambient temperature: -10°C - 40°C.
3. Avoid high temperature and high moisture, humidity < 90% RH, no dripping rain or other liquid.
4. Do not install inverter onto wood or other flammable materials.
5. No direct sunlight.
6. No flammable or corrosive gas or liquid.
7. No dust, oily dust or floating fiber or metal particle.
8. Installation base shall be solid and free from vibration.
9. No electromagnetic interference and away from interference source.

2.3.2 Ambient Temperature

For reliability purpose, please install inverter at a well-ventilated place. A cooling fan or an air-conditioner shall be installed and ambient temperature shall be kept below 40°C, when inverter is installed in a closed box.

2.3.3 Precautions

Please take precautions during installation to prevent metal fragments or dusts produced by drilling or other actions from falling into inverter. Remove project objects after installation.

2.4 Installation Direction and Space

EM600 must be installed with a cooling fan for inverter for forced air cooling and must be installed in vertical direction with enough space maintained to an adjacent object or a baffle (wall) for better cooling effect (see Figure 2–2).

EM600 series inverters for 450 kW and above are equipped with a cooling fan with forced air cooling, its special air duct design can meet the installation and left and right sides of the ark, cabinet leave maintenance operation space before and after.

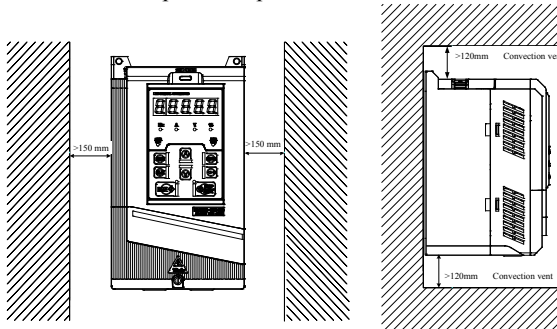

Figure 2-2 Inverter Installation Direction and Space

2.5 Assembly and Disassembly of Keypad

Generally speaking, it's not necessary to disassemble keypad while using inverter. What to do is to open terminal block. If necessary, observe the following methods to disassemble or install keypad.

- Disassemble keypad: Put your fingers in finger slots on the top of keypad, press down keypad slightly and pull it outward (Figure 2–3).

Step 1:

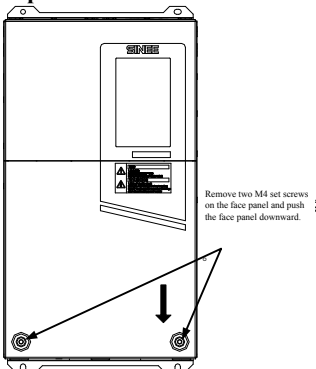

Step 2:

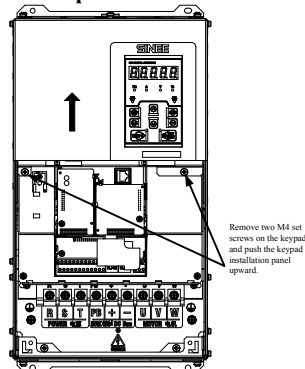

Step 3:

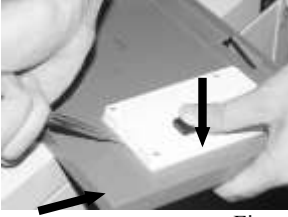

Step 4:

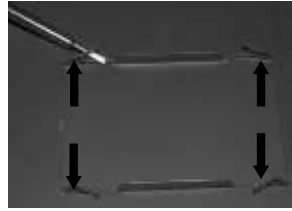

Figure 2-3 Disassemble Keypad

- Assemble keypad: Make RJ-45 terminal aligned with the modular plug at keypad bottom horizontally, and press keypad flatly until it clicks into the right place. See Figure 2-4.

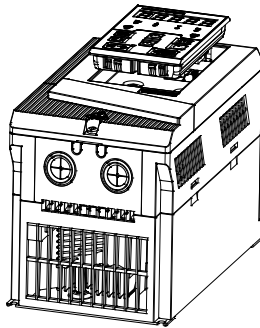

Figure 2-4 Keypad Installation

2.6 Flush Mounting

EM600 inverter (5.5 kW – 200 kW) can be changed to flush mounting type.

Installation of EM600 inverter (22 kW or above): remove top and bottom mounting holes of original housing (Figure 2-5) to the position shown in Figure 2-6, and install removed bolts back to the said mounting holes again.

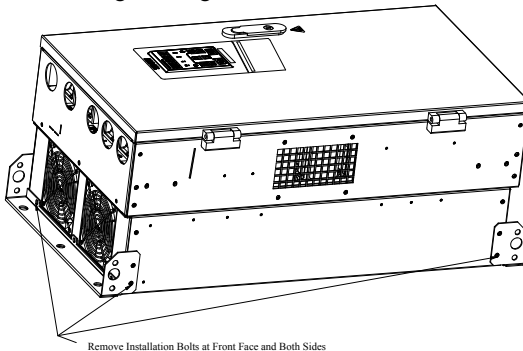

Figure 2-5 Disassemble Top and Bottom Mounting Holes

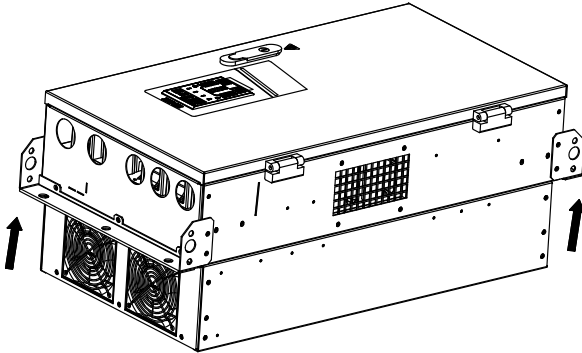

Figure 2-6 Assemble Top and Bottom Mounting Holes

Installation of EM600 inverter (below 22 kW): as shown in 2-7, insert left and right accessories for flush mounting into slots at the left and right sides of plastic shell, and tighten the two front and back screws. See Figure 2-8 Installation Dimensions for Flush Mounting and Table 2-3 for installation dimensions.

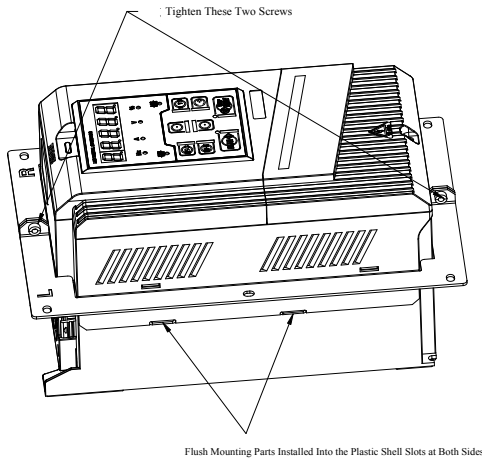

Figure 2-7 Left and Right Accessories for Flush Mounting

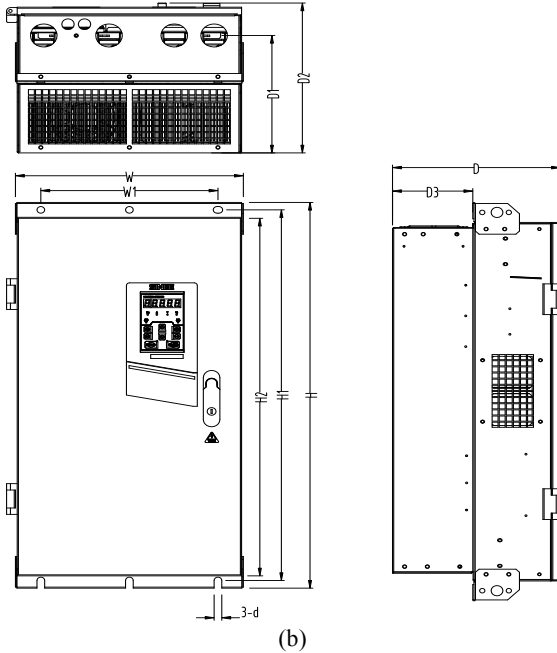
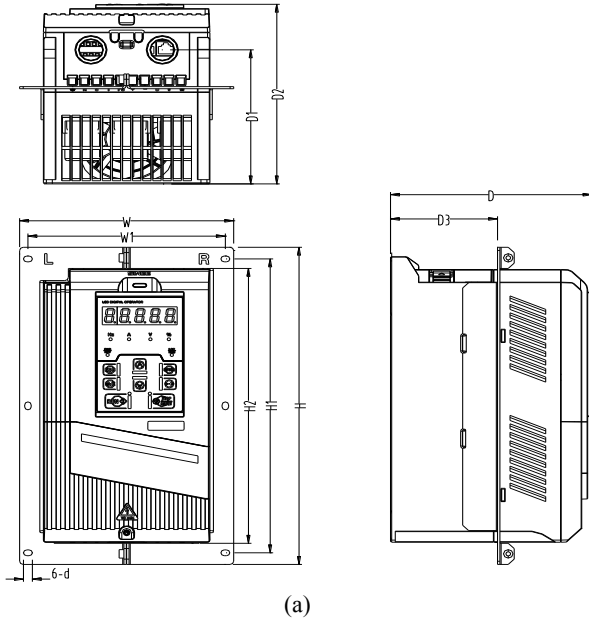

Figure 2-8 Installation Dimensions for Flush Mounting

Table 2-3 Installation Dimensions for Flush Mounting

Model No.	W	W1	H	H1	H2	D	D1	D2	D3	d	Frame
EM600-5R5-3B	188	166	300	278	258	172	128	172	90	5.5	a
EM600-7R5-3B											
EM600-011-3B	224	150	431	409	343	210	165	210	122	8	a
EM600-015-3B											
EM600-018-3B											
EM600-022-3/3B	250	200	484	470	440	214	150	222	122	6.5	b
EM600-030-3/3B											
EM600-037-3/3B											
EM600-045-3/3B	315	220	560	546	513	242	180	250	140	7	b
EM600-055-3/3B	350	250	662	638	603	254	188	262	138	12	b
EM600-075-3/3B											
EM600-090-3	386	300	753	724	700	287	231	295	136	13	b
EM600-110-3	416	300	855	825	793	302	246	310	132	13	b
EM600-132-3											
EM600-160-3	497	397	1107	1076	1036	335	285	343	145	13	b
EM600-185-3											
EM600-200-3											

3 Wiring

3.1 Connection to Peripherals

Standard connection between EM600 and peripherals is shown in Figure 3-1.

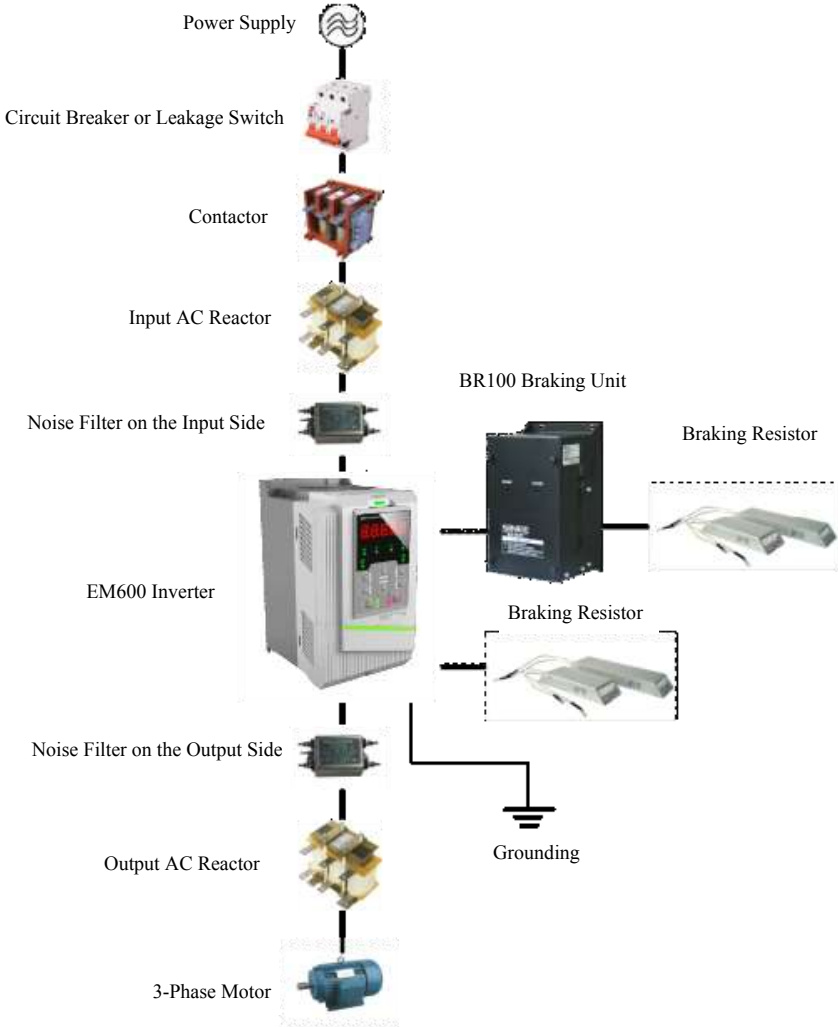

Figure 3-1 Connection of EM600 Inverter and Peripherals

3.2 Wiring Main Circuit Terminals

3.2.1 Main Circuit Terminal Block

Main circuit terminals of EM600 comprise the following parts:

- 3-phase AC input terminals: R, S and T
- Grounding terminal: \perp
- DC bus terminal: $\oplus \ominus$
- Wiring terminal for energy consumption braking resistor: PB
- Wiring terminals of motor: U, V and W

See Figure 3–2 for main circuit terminal block.

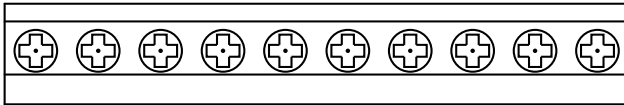

a) Main Circuit Terminal Block of Models 0.75 - 7.5 kW

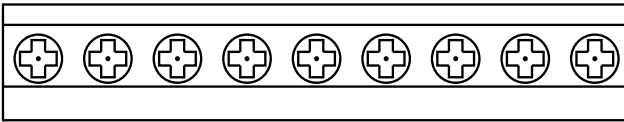

b) Main Circuit Terminal Block of Models 11 - 18.5 kW

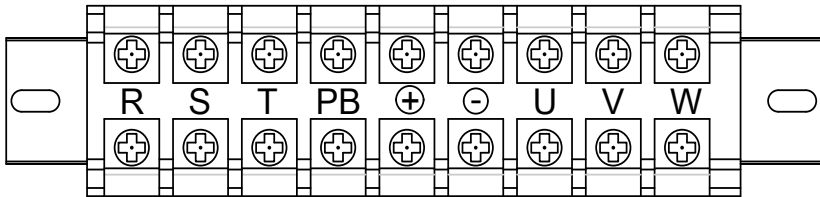

c) Main Circuit Terminal Block of Models 22 - 37 kW

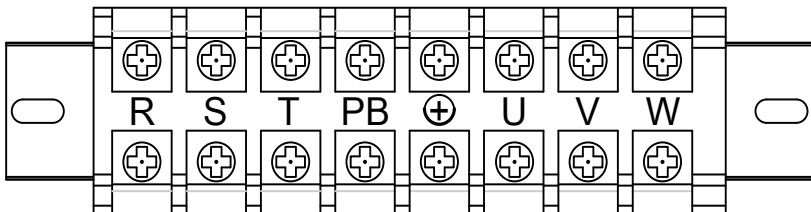

d) Main Circuit Terminal Block of Models 45 - 75 kW (None internal brake unit PB is \ominus)

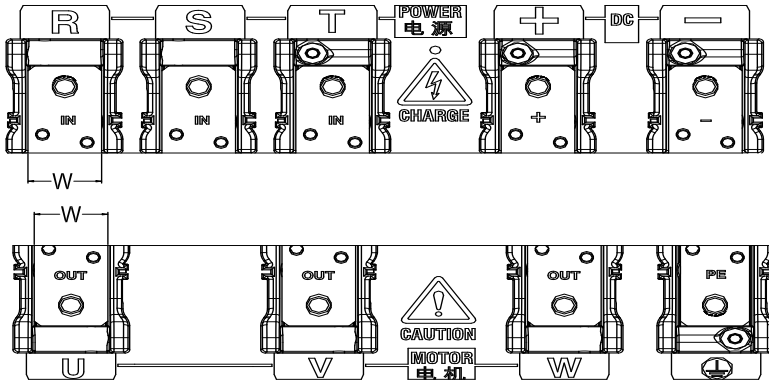

e) Main Circuit Terminal Block of Models 90 kW - 200 kW(380V) and 160-220kW(660V)

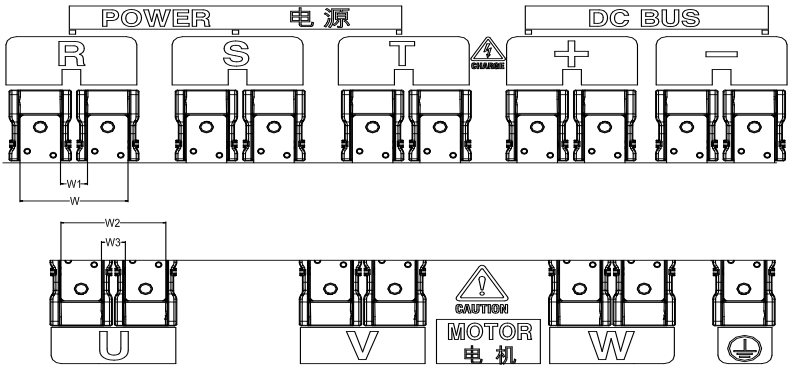

f) Main Circuit Terminal Block of Models 220 kW - 400 kW

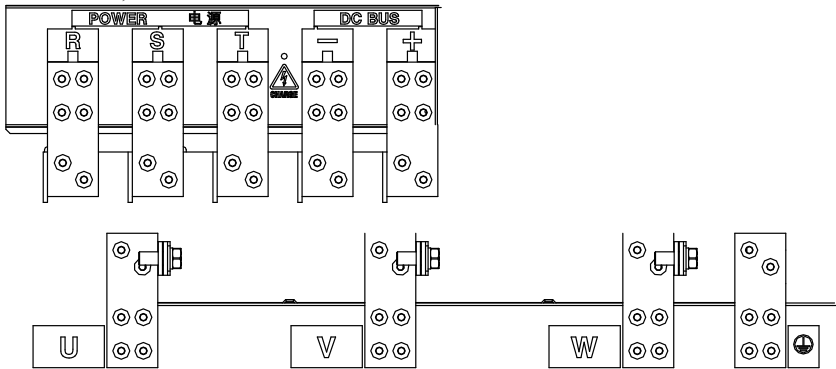

g) Main Circuit Terminal Block of Models 450 - 560 kW

Figure 3-2 Main Circuit Terminal Block

Table 3-1 90 kW – 400 kW Terminal Dimension

Model No.	W	W1	W2	W3
EM600-090 ~ 132-3	33	-	-	-
EM600-160 ~ 200-3/ EM600-160 ~ 220-6	39	-	-	-
EM600-220 ~ 280-3	88	22	88	22
EM600-315 ~ 400-3	104	26	101	23

Note: 1. 90 kW or above: Power input terminals are on the top and power output terminals are at the bottom of inverter.

2. 220 kW or above: There are 2 wiring terminal blocks for each phase.

3.2.2 Main Circuit Terminal Functions

Main circuit terminal functions of EM600 are shown in Table 3–2 and please correctly wire terminals according to functions.

Table 3–2 Main Circuit Terminal Functions

Terminal No.	Function Description
R, S and T	AC power supply input terminal, to be connected to 3-phase AC power supply.
U, V and W	AC output terminals of Inverter, to be connected to 3-phase AC motor.
⊕ ⊖	Positive and negative terminals of internal DC bus, to be connected to external braking unit
⊕, PB	Connecting terminals of braking resistor, one end connected to ⊕ and the other end to PB.
⊖	Grounding terminal

3.2.3 Internal Main Circuit

Internal main circuit structure of EM600 is shown in Figure 3–3.

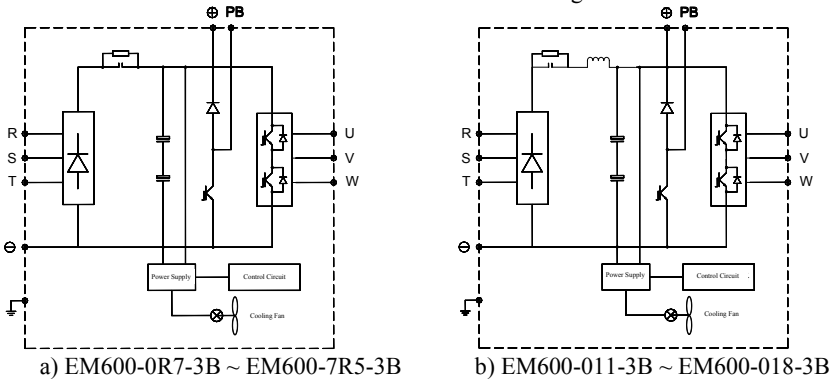

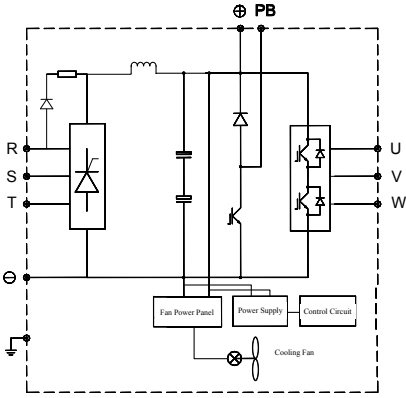

c) EM600-022-3B ~ EM600-075-3B

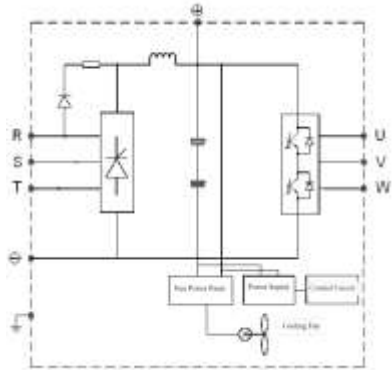

d) EM600-022-3 ~ EM600-200-3 and EM600-160-6 ~ EM600-220-6

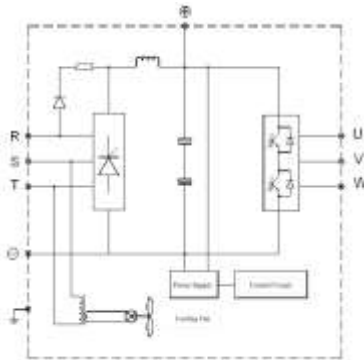

e) EM600-220-3 - EM600-560-3

Figure 3-3 Internal Main Circuit of Inverter

3.2.4 Standard Wiring of Main Circuit

Standard wiring of main circuit of EM600 inverter is shown in Figure 3-4.

- EM600-0R7-3B - EM600-075-3B

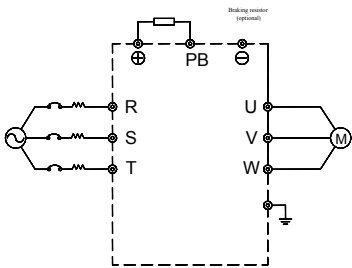

- EM600-022-3 - EM600-075-3

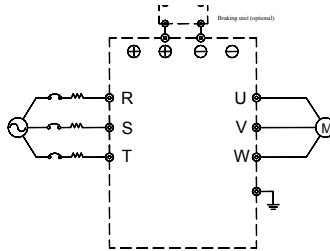

Figure 3-4 Standard Wiring of Main Circuit

3.2.5 Wiring of Main Circuit on Input Side

3.2.5.1 Circuit Breaker Installation

An air circuit breaker (MCCB) matching with inverter shall be installed between power supply and input terminal.

- MCCB capacity shall be 1.5 to 2 times that of rated current of inverter.
- MCCB must meet time characteristics of overheating protection of inverter (150% rated current/1 minute).
- When MCCB is used with multiple inverters or other devices, please connect fault output relay contactor to power contactor coil, so that power supply will be turned off by fault signal (Figure 3-5).

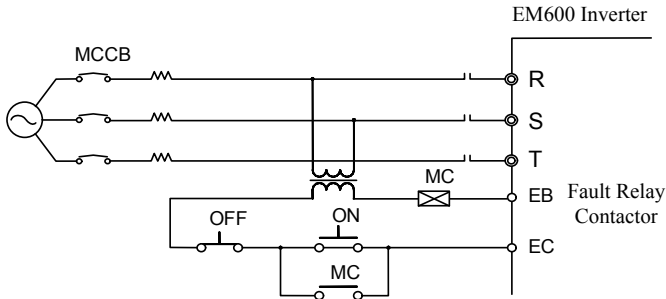

Figure 3-5 Connecting to Input Circuit Breaker

3.2.5.2 Leakage Circuit Breaker Installation

Inverter outputs high-frequency PWM signal, which generates high-frequency leakage current. Please select a leakage circuit breaker with trigger current $\geq 30\text{mA}$. For regular circuit breaker, trigger current shall be $\geq 200\text{mA}$ and active time at 0.1 s or above.

3.2.5.3 Electromagnetic Contactor Installation

Connect electromagnetic contactor matching with inverter power as shown in Figure 3-4.

- Do not control inverter start or stop with electromagnetic contactor on the input side. Frequent use of this method is an important cause of damaging the inverter. Operation interval between inverter start and stop shall not be longer than 30 minutes.
- Inverter will not automatically start after power failure.

3.2.5.4 Connection to Terminal Block

Input power can be connected to R, S and T randomly irrespective of their phase sequence on terminal block.

3.2.5.5 AC Reactor Installation

Excessive surge current may be generated when inverter is connected to a large capacity (over 600 KVA) power transformer or input power supply is connected to a capacitive load, and this may damage rectifier. Connect a 3-phase AC reactor (optional) to input side of inverter, which not only suppresses peak current and voltage, but also improves power factors of system.

3.2.5.6 Surge Suppressor Installation

It's required to install a surge suppressor, if there is an inductive load near inverter, for example electromagnetic contactor, solenoid valve, solenoid coil and electromagnetic circuit breaker.

3.2.5.7 Noise Filter Installation at Power Supply Side

Noise filter can suppress the noise transmitted between power cable and inverter and impacts of the noise generated by inverter on the power grid.

- Special noise filter is required for inverter; general noise filter is not adopted for effect purpose.
- Correct and incorrect installation methods of noise filter (Figure 3–6 and Figure 3–7).

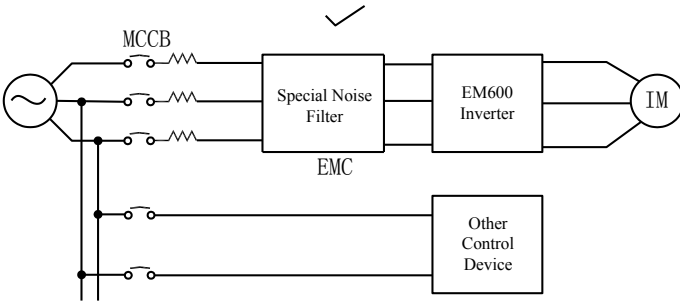

Figure 3–6 Correct Installation of Noise Filter

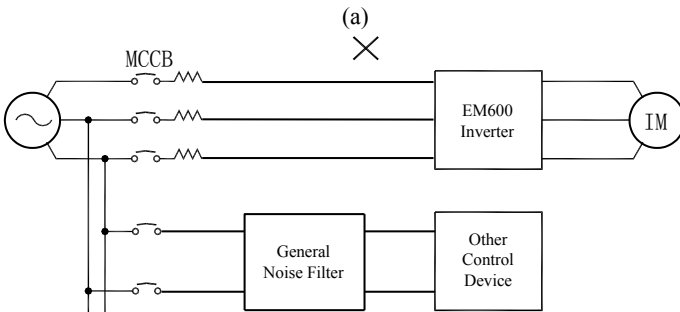
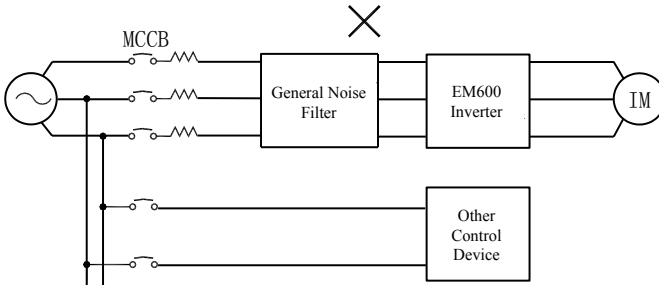

Figure 3-7 Incorrect Installation of Noise Filter

3.2.6 Wiring of Main Circuit on Output Side

3.2.6.1 Inverter and Motor Connection

Connect output terminals U, V and W of inverter to input terminals U, V and W of motor. Confirm whether motor runs forward after receiving a forward running command. If not, please switch any two connection cable of output terminals U, V and W of inverter.

3.2.6.2 Never Connect Power Supply Cable to Output Terminals

Never connect power supply cable to output terminals. If output terminals are connected to power supply, internal parts of inverter would be damaged.

3.2.6.3 Never Short-Circuit or Ground Output Terminals

Never touch output terminals with bare hands or connect output cable to inverter housing, so as to avoid electric shock or short circuit. In addition, do not short-circuit output cable.

3.2.6.4 Never Use an Phase-Shifting Capacitor

Never connect a phase-shifting electrolytic capacitor or an LC/RC filter to output circuit so as to prevent inverter from being damaged.

3.2.6.5 Never Use Electromagnetic Switch

Do not connect a solenoid switch or an electromagnetic contactor to output circuit. Otherwise, it will trigger overcurrent or overvoltage protection or damage internal parts of inverter.

To set an electromagnetic contactor for switching grid frequency power supply, stop inverter and motor at first.

3.2.6.6 Noise Filter Installation at Output Side

Connecting a noise filter to output side of inverter can reduce inductive interference and radio interference.

- Inductive interference: Signal line contains noises caused by electromagnetic induction, thus resulting in incorrect action of control devices.
- Radio interference: High-frequency electromagnetic waves transmitted by inverter and cable will cause radio devices nearby to make noises while receiving signal.
- Noise filter is installed on the output side (as shown in Figure 3-8).

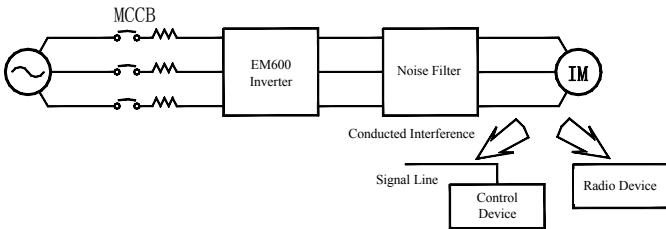

Figure 3-8 Noise Filter Installation on the Output Side

3.2.6.7 Countermeasures Against Inductive Interference

In addition to installing noise filter, wiring all output cable into grounded metal pipe to suppress inductive interference on the output side. When output cable is over 30 cm away from signal line, inductive interference decreases substantially (Figure 3-9).

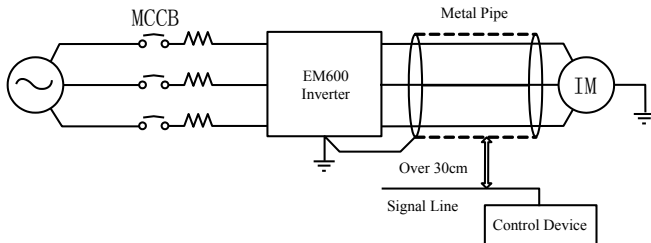

Figure 3-9 Countermeasures Against Inductive Interference

3.2.6.8 Countermeasures Against RF Interference

RF interference can be produced by input cable, output cable or inverter and reduced by installing noise filter on both input and output sides and covering inverter with iron box. See Figure 3-10.

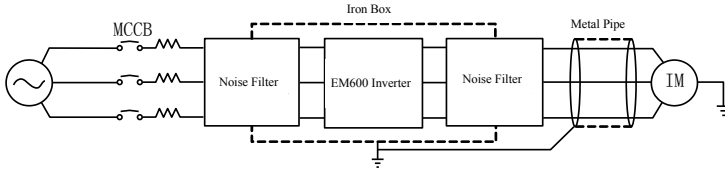

Figure 3-10 Countermeasures Against RF Interference

3.2.6.9 Wiring Distance Between Inverter and Motor

The longer the wiring distance between inverter and motor is, the higher carrier frequency will be and the greater the high-frequency harmonic leakage current on its cable will be accordingly. As a result, an adverse impact may be produced upon inverter and its devices nearby. Adjust carrier frequency by reference to Table 3-3 to reduce the high-frequency leakage current.

- If motor cable is over 50m, connect a 3-phase inverter output AC reactor of the same capacity to terminals U, V and W of inverter.

Table 3-3 Wiring Distance and Carrier Frequency Between Inverter and motor

Wiring Distance Between Inverter and Motor	Below 50 m	Below 100 m	Above 100 m
Carrier Frequency	Below 10 kHz	Below 8 kHz	Below 5 kHz
Function Code F00.23	10.0	8.0	5.0

3.2.7 Main Circuit Cable and Terminal Screw Size

Main circuit cable and terminal screw sizes are shown in Table 3-4.

Table 3-4 Cable and Terminal Screw Specifications

Model No.	Terminal Symbol	Terminal Screw	Tightening Torque (N.m)	Cable Size (mm ²)	Cable Type
EM600-0R7-3B	⊕, ⊖, R, S, T, U, V, W, PB, ⊕	M3.5	1.2 - 1.5	1.5	750 V cable
EM600-1R5-3B				2.5	
EM600-2R2-3B				4	
EM600-4R0-3B		M4	1.5 - 2.0	6	
EM600-5R5-3B					
EM600-7R5-3B	R, S, T, PB, ⊕, ⊖, U, V, W	M5	3.0 - 4.0	10	
EM600-011-3B					
EM600-015-3B		M6	4.0 - 5.0	16	
EM600-018-3B				25	
EM600-022-3/3B		M8	9.0 - 10.0	35	
EM600-030-3/3B					
EM600-037-3/3B	R, S, T, PB, ⊕, U, V, W	M10	17.0 - 22.0	60	
EM600-045-3B					
EM600-055-3B					
EM600-075-3B					

Model No.	Terminal Symbol	Terminal Screw	Tightening Torque (N.m)	Cable Size (mm ²)	Cable Type				
EM600-045-3	R, S, T, ⊖, ⊕, U, V, W	M8	9.0 - 10.0	35					
EM600-055-3		M10				17.0 - 22.0			
EM600-075-3							60		
EM600-090-3	R, S, T, ⊕, ⊖, U, V, W, ⊕	M12	31.0 - 39.0	90					
EM600-110-3				120					
EM600-132-3				180					
EM600-160-3				2*M10		17.0 - 22.0	2*120		
EM600-185-3							2*M12	31.0 - 39.0	2*150
EM600-200-3									2*180
EM600-220-3	2*M16	45.0~55.0	2*270						
EM600-250-3									
EM600-280-3									
EM600-315-3									
EM600-355-3									
EM600-400-3									
EM600-450-3									
EM600-500-3									
EM600-560-3									

Note: 1. Take voltage drop into consideration for selecting cable. Generally speaking, the voltage drop value calculated by the following formula shall be less than 5 V.

$$\text{Voltage drop} = \sqrt{3} * \text{Cable Resistor } (\Omega/\text{KM}) * \text{Cable Length (m)} * \text{Rated Current (A)} * 10^{-3}$$

- If power cable is laid in plastic duct, it shall be one grade higher.
- Cable shall be connected to round wiring terminals of applicable cable and terminal screw.
- Size of grounding cable shall be the same as power cable (if less than 16 mm²), or not less than 1/2 of power cable (if greater than 16 mm²) and at least 16 mm² is a must.

3.2.8 Grounding Cable

- Ground terminal $\underline{\text{⏏}}$ must be grounded.
- The third type grounding method specially (grounding resistance less than 10 Ω).
- Never share grounding cable with welder, power device or other devices.
- Please select grounding cable of specifications in *Technical Standards of Electrical Equipment* and keep it as short as possible when connecting to ground point.
- Do not allow grounding cable to form a circuit when two or more inverters are used. Correct and incorrect grounding methods are shown in Figure 3-11.

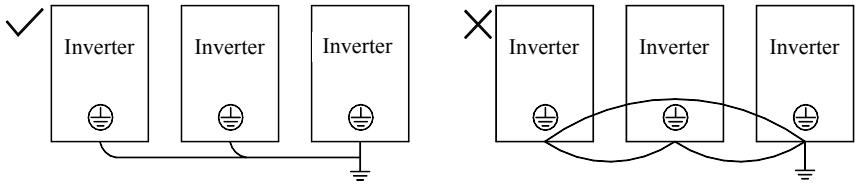

Figure 3-11 Connection Methods of Grounding Cable

3.2.9 Braking Resistor and Braking Unit Wiring

See Chapter 11 for type selection and wiring methods of braking resistor and braking unit.

3.3 Wiring Control Circuit Terminals

3.3.1 Control Circuit Terminals

Control circuit terminals are located at the bottom front of terminal block and PCB and comprise:

- Analog input terminals: AI1, AI2 and AI3.
- Numeric input terminals: X1, X2, X3, X4, X5, X6 and X7.
- Numeric output terminals: Y1 and Y2.
- Relay output terminals: R1: EA-EB-EC, R2: RA-RB-RC.
- Analog output terminals: M1 and M2.
- Auxiliary power supply terminals: PLC, +24V, COM, +10V and GND
- RS485 communication interface: A+ and A-.
- CAN interface: CANH and CANL (Option)
- Ground terminal: PE.

See Figure 3–12 for control circuit terminal block

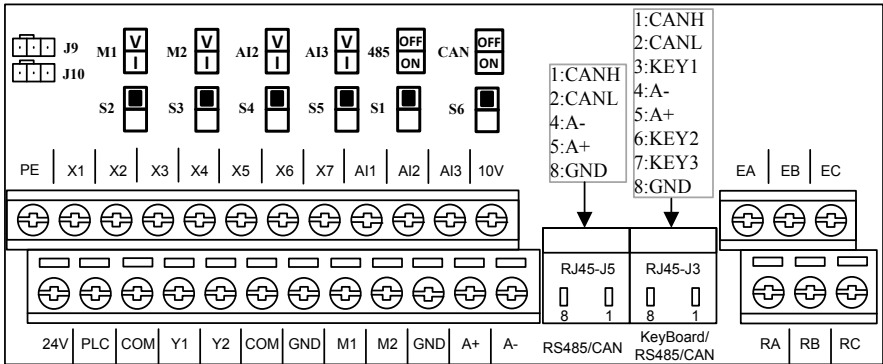

Figure 3-12 Control Circuit Terminal Block

Note: Jump wires J9 and J10 of terminal block are equipped by the manufacturer. No user is allowed to change them; otherwise inverter may not work normally.

3.3.2 Function and Wiring of Control Circuit Terminals

See Table 3–5 for functions of control circuit terminals.

Table 3-5 Control Circuit Terminal Functions

Mode	Terminal No.	Terminal	Terminal Function
Auxiliary Power Supply	10V-GND	+10V Power Supply	Offers +10V power supply, maximum output current: 20mA.
	24V-COM	+24V Power Supply	Offers +24V power supply, generally used as working power supply for numeric input or output terminal, or external device power supply. Maximum output current: 200mA
	PLC	Common Multi-function Input Terminal	As factory default, it is connected to 24 V power supply. When driving numeric input terminal with external power supply, disconnect it from 24V terminal and connect it to external power supply.
Analog Input	AI1-GND	Analog Input Terminal 1	Input voltage range: DC 0 - 10 V Input impedance: 1M Ω
	AI2-GND	Analog Input Terminal 2	Input range: DC 0 - 10 V/0 - 20 mA; select voltage/current mode by switch S4 on terminal block Input impedance: voltage mode 1 M Ω , current mode 250 Ω
	AI3-GND	Analog Input Terminal 3	Input range: DC 0 - 10 V/0 - 20 mA; select voltage/current mode by switch S5 on terminal block. Input impedance: voltage mode 1 M Ω , current mode 250 Ω
Numeric Input	X1-COM	1 Analog Input Terminal 1	Optocoupler isolation, compatible with bipolar input of NPN and PNP. Input impedance: 4.5 k Ω Input voltage range: 9 - 30 V
	X2-COM	Multi-function Input Terminal 2	
	X3-COM	Multi-function Input Terminal 3	
	X4-COM	Multi-function Input Terminal 4	
	X5-COM	Multi-function Input Terminal 5	
	X6-COM	Multi-function Input Terminal 6	
	X7-COM	High Speed Pulse Input Terminal	In addition to being used as multi-function input terminal, it can be used as high speed pulse input terminal as well with maximum response frequency of 100 kHz. Input voltage: 12 - 48 V

Mode	Terminal No.	Terminal	Terminal Function
			Input impedance: 1 kΩ
Analog Output	M1-GND	Analog Output Terminal 1	Output range: DC 0 - 10 V/0 - 20 mA; selected by switch S2 on terminal block.
	M2-GND	Analog Output Terminal 2	Output range: DC 0 - 10 V/0 - 20 mA; selected by switch S3 on terminal block.
Multi-Function Output	Y1-COM	OC Output Terminal	Optocoupler isolation, OC output Maximum output voltage: DC 48V Output current: 50 mA
	Y2-COM	High Speed Pulse Output Terminal	Optocoupler isolation, OC output Maximum output voltage: DC48V Maximum output current: 50 mA For high speed pulse output, maximum output frequency 100 kHz Output impedance <5 kΩ
Relay Output	R1:EA-EB-EC	Relay Output Terminal	EA-EC: NO EB-EC: NC
	R2:RA-RB-RC		RA-RC: NO RB-RC: NC
Communication	A+	RS-485 communication Terminal	RS485 communication input (+)
	A-		RS485 communication input (-)
	CANH	CAN port	CAN communication input (+)
	CANL		CAN communication input (-)
Shield	PE	Shielded Ground	For shielded ground of terminal cable

3.3.3 Analog Input Terminal Wiring

3.3.3.1 Wiring Terminals AI1, AI2 and AI3 Through Analog Voltage Signal:

When selecting analog voltage signal input for terminals AI2 and AI3, please configure voltage mode through switches S4 and S5 of terminal block. See Figure 3-13.

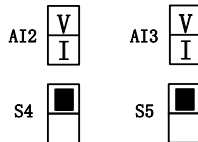

Figure 3-13 Configuring Voltage Modes with S4 and S5

When analog voltage input signal is powered by external power supply, terminals AI1, AI2 and AI3 are wired as Figure 3-14-a.

When analog voltage input signal is generated by potentiometer, terminals AI1, AI2 and AI3 are wired as Figure 3-14-b.

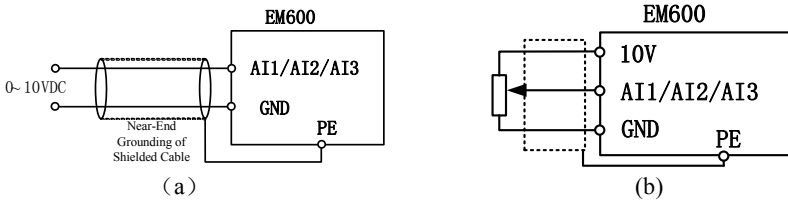

Figure 3-14 Wiring of Terminals AI1, AI2 and AI3

3.3.3.2 Wiring Terminals AI2 and AI3 (Input Analog Current Signal):

When selecting analog current signal input on terminals AI2 and AI3, please configure current mode through switches S4 and S5 of terminal block. See Figure 3-15.

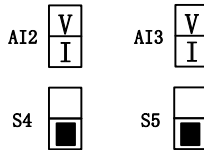

Figure 3-15 Configuring Current Modes with S4 and S5

3.3.4 Wiring of Terminals AI2 and AI3 in Figure 3-15

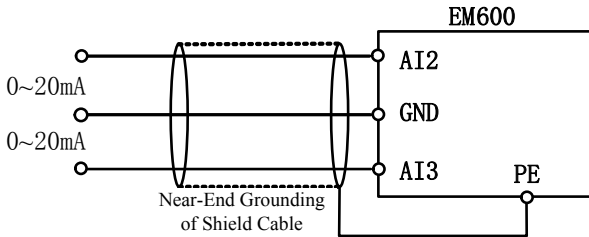

Figure 3-16 Wiring of Terminals AI2 and AI3

3.3.5 Wiring of Multi-function Input Terminal

Multi-function input terminals of EM600 inverter adopt full bridge rectifier. The current passing through PLC terminal can be either forward (NPN Mode) or reverse (PNP Mode), so that it is flexible to connect terminals X1 - X7 to external devices. Typical wiring methods are as shown in the following figure 3-17:

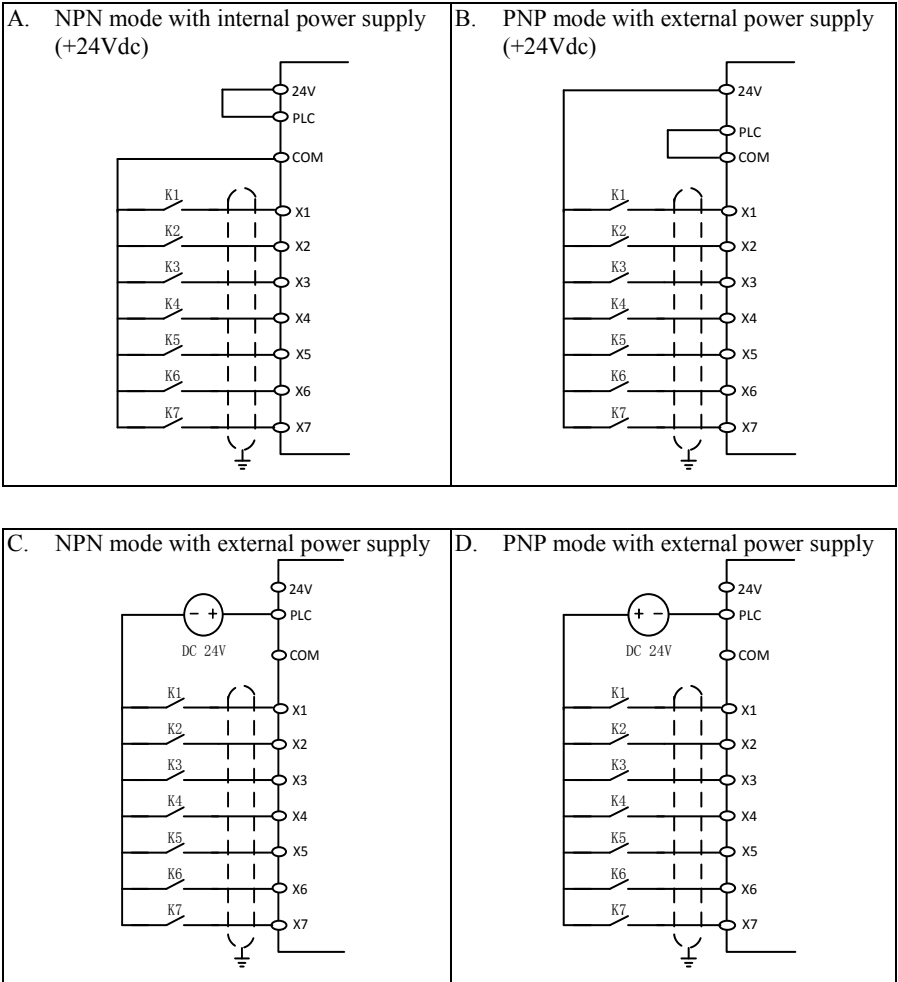

Figure 3-17 Wiring of Multi-function Input Terminals

Note: Wiring of relay output terminal of short-circuiting bar between 24V power supply and PLC terminal must be removed, when using an external power supply.

Absorption circuit of surge voltage shall be installed to drive inductive load (for example relay and contactor), for example RC absorption circuit (please note that the leakage current shall be less than holding current of contactor or relay under control), VDR and fly-wheel diode (for DC electromagnetic circuit, please pay attention to the polarity at installation). Components of absorption circuit shall be installed near two sides of relay or contactor coil.

3.3.6 Wiring of Multi-function Output Terminal

Y1 and Y2 can be powered by internal 24V or external supply. See Figure 3-18.

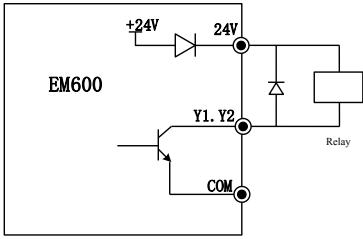

a. Internal power supply

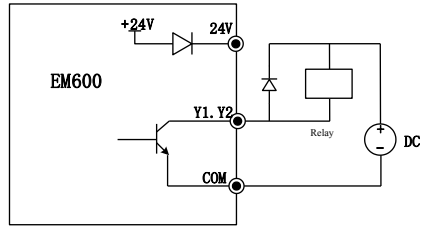

b. External power supply

Figure 3-18 Wiring of Multi-function Output Terminal



1. An antiparallel diode must be added, in order to use an internal power supply (as shown in Figure 3-18-a).

3.3.7 Analog Output Terminal Wiring

External analog table of analog output terminals M1 and M2 may indicate multiple physical quantities. Select (0 - 20 mA) or (0 - 10 V) by DIP switch; M1 corresponds to S2; M2 corresponds to S3. Wiring of DIP switch and terminal is as follows:

	<table border="1"> <tr> <td>V</td> <td><input type="checkbox"/></td> <td>M1 for analog voltage output</td> </tr> <tr> <td>I</td> <td><input type="checkbox"/></td> <td>M1 for analog current output</td> </tr> </table>	V	<input type="checkbox"/>	M1 for analog voltage output	I	<input type="checkbox"/>	M1 for analog current output	S2
		V	<input type="checkbox"/>	M1 for analog voltage output				
	I	<input type="checkbox"/>	M1 for analog current output					
	<table border="1"> <tr> <td>V</td> <td><input type="checkbox"/></td> <td>M2 for analog voltage output</td> </tr> <tr> <td>I</td> <td><input type="checkbox"/></td> <td>M2 for analog current output</td> </tr> </table>	V	<input type="checkbox"/>	M2 for analog voltage output	I	<input type="checkbox"/>	M2 for analog current output	S3
V		<input type="checkbox"/>	M2 for analog voltage output					
I	<input type="checkbox"/>	M2 for analog current output						

3.3.8 Wiring of Communication Terminal

Communication terminals A+ and A- are RS485 communication interfaces of inverter. Realize networking control of host controller (PLC or PLC controller) and inverter by connecting to host controller for communication. RS485, RS485/RS232 converter and EM600 inverter are wired as per Figures 3-19, 3-20 and 3-21.

- RS485 terminal of single inverter directly connects to host controller for communication:
-

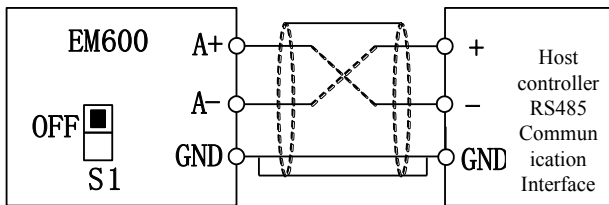

Figure 3-19 Wiring of Single Inverter Communication Interface

- RS485 terminals of multiple inverters connect to host controller for communication:

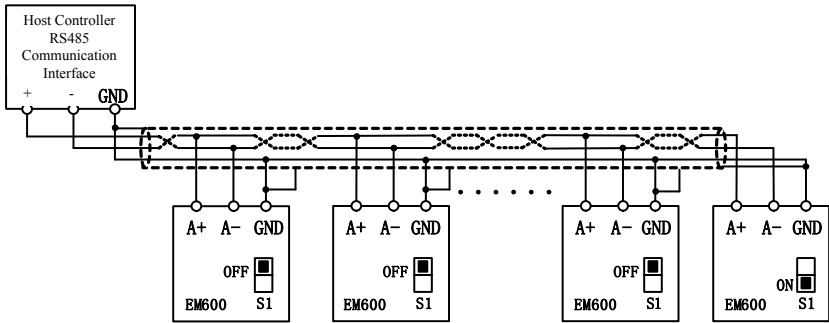

Figure 3-20 Wiring of Communication Interfaces of Multiple Inverters

- Connect to host controller for communication through RS485/RS232 converter

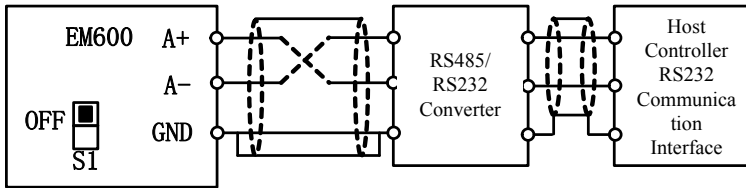

Figure 3-21 Wiring of Communication Interface

3.3.9 Control Circuit Cable and Screw Size

- Length of cable for transmitting control signal shall be limited to 50 m and its distance from power cable shall be greater than 30 cm, in order to reduce interference and attenuation of control signal. Please use shielded twisted-pair cable when analog signal is inputted externally.
- It's recommended to use 0.5 - 1 mm² cable as control circuit cable.
- Terminal block of EM600 inverter shall be through control circuit connection terminal. Please use a PH0 cross screwdriver for installation with tightening torque of 0.5 N.m.

3.3.10 Attentions for Control Circuit Wiring

- Separate control circuit cable from other cable.
- Separate cable of control circuit terminals EA, EB, EC, Y1 and Y2 from cable of other control circuit terminals.
- To prevent malfunctions caused by interference, use shielded twisted-pair cable for control circuit, with the wiring distance less than 50m.
- Wrap shield net with insulating tape to prevent the shield net from contacting with other signal cable and housing of device.
- It's not allowed to contact various ports or components without ESD measures.

3.3.11 Standard Wiring of Control Circuit

Standard wiring of control circuit of EM600 inverter is shown in Figure 3–22.

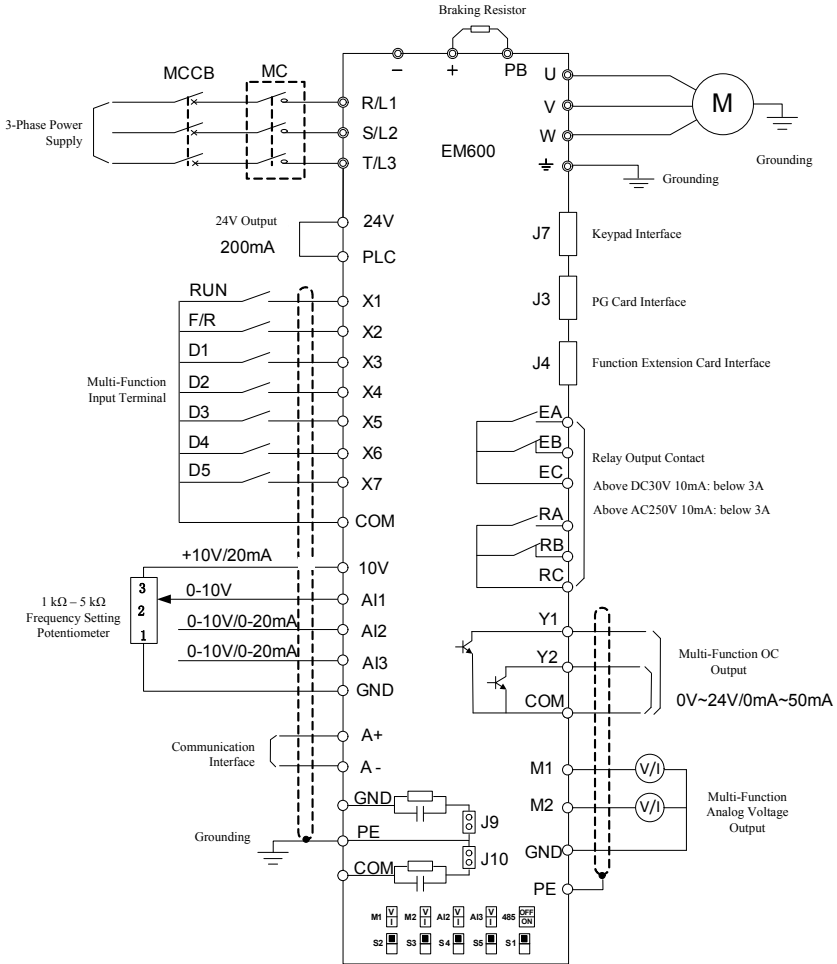

Figure 3-22 Standard Wiring of Control Circuit

3.4 Extending Keypad Wire

- 1) External keypad interface adopts RJ45 interface and extending wire is common network cable (connection plug executes standard EIA/TIA568B).
- 2) Figure 3-23 Wiring of Keypad Extension Line
 Wiring mode will facilitate your installation and debugging greatly. It's recommended that keypad extension line not be longer than 3m. If cable above cat5 is used and electromagnetic environment is good, extension line can be up to 15 m.

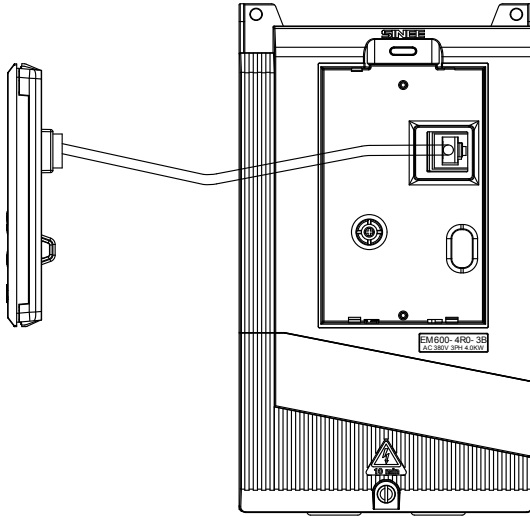

Figure 3-23 Wiring of Keypad Extension Line

3.5 Wiring Verification

Verify the following items after wiring:

- Whether wiring is incorrect.
- Whether there are screws, connector plugs or wire fragments inside inverter.
- Whether screws are loosened.
- Whether bare wire on one terminal connects to oterminals.

4 Keypad Operation

4.1 Keypad Function

4.1.1 Structure of LED Keypad

Control panels of EM600 can be classified into two categories: LED keypad and LCD keypad.

LED keypad comprises a 5-bit LED display, 8 operation buttons and 8 status and unit indicators.

User may operate inverter by keypad through parameter setting, status monitoring, start/stop operation, etc. Appearance and function area of keypad are as shown in Figure 4-1.



















Figure 4-1 LED Keypad

4.1.2 Functions of Buttons and Indicators of LED Keypad

Functions of buttons and indicators of LED keypad are shown in Table 4-1.

Table 4-1 Functions of Buttons and Indicators of LED Keypad



Button/Indicator	Name	Function
	Right Shift	Select group number and function code of current function parameters under selection. Select bit switch monitoring parameters of parameters under selection.
	Escape	Back to previous menu. Escape from editing present parameter by entering menu mode from monitoring mode.
	Multi-Functional Programmable Button	For non-function, JOG forward, JOG reverse, forward/reverse switch, fast stop, coast to stop and cursor left shift options through function code F12.00.
	Enter	Enter next menu. Confirm and save parameter modification and enter next parameter.
	Run	Press this button to start inverter if keypad control is valid. Fault State to reset the fault.
	Stop/Reset	Press this button to stop inverter if keypad control is active. In fault status, back to parameter setting status.

Button/Indicator	Name	Function
	Up	Select function code, menu group or increase set parameter value. Increase numeric input data of present effective reference.
	Down	Select function parameter, menu group or decrease set parameter value. Decrease numeric input data of present effective reference.
	LED	Display function setting, running monitoring, fault monitoring code and parameter.
	Frequency Indicator	On when present parameter is frequency.
	Current Indicator	On when present parameter is current.
	Voltage Indicator	On when present parameter is voltage.
	Percentage Indicator	On when present parameter is percentage.
	Forward/Reverse Indicator	On at the time of monitoring or displaying some special frequency as negative. On when reversing
	Communication Control Indicator	On when F00.02 is set to keypad control, off when F00.02 is set to terminal control, flickers when F00.02 is set to communication control.
	Status Indicator	On when inverter is running, flickers when stopping, off after stop.
	Fault Indicator	On when inverter is in fault state.

4.2 LED Keypad Operation Mode

4 menu levels of LED keypad: monitoring (level 0), menu mode selection (level 1), function code selection (second level) and parameter value (third level). In the following parts, menu levels are represented by figures.

3 parameter display modes: all menu mode (--A--) displays all function codes; user-defined mode (--U--), only displays function parameters selected by user through F11 group; non-factory defaults (--C--), only displays those function codes that are different from the factory setting.

When keypad is powered, default display is the first monitoring parameter of level 0; press  to enter menu level 1, from which using  and  to select a menu mode.

Operation procedure for menu mode selection is shown in Figure 4-2.

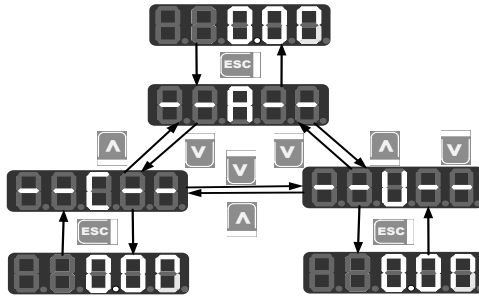

Figure 4-2 Operation Procedure of Menu Mode Selection

4.2.1 All menu mode (--A--)

Press **ENTER** under the all menu mode to enter the second level menu to select any function code. Press **ENTER** again to enter the third level menu to review or modify function parameters. Except some special function parameters, those function parameters needed by users can be modified.

Under the all menu mode, the whole operation procedure from power-on and initialization to value change of F03.28 to 5.28 is shown in Figure 4-3.

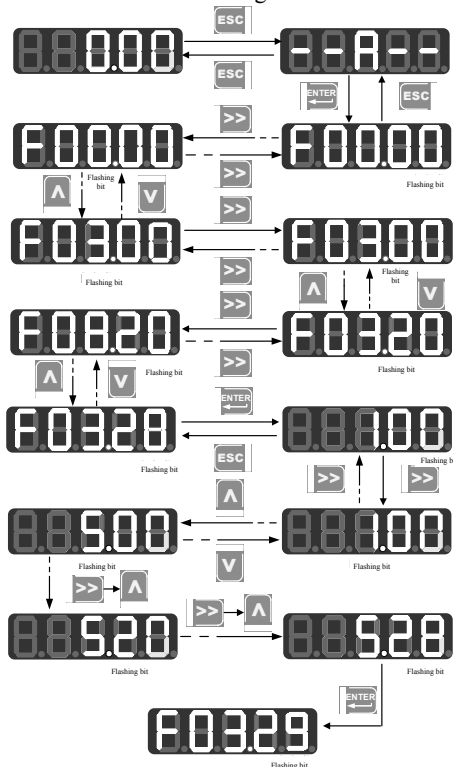

Figure 4-3 Operation Procedure from Power-on to Setting F03.28=5.28

Under all menu modes, press **ENTER** to save parameter change after having changed parameter. The difference is that after having saved the parameter: it enters next function code under all menu mode; it enters next user-defined function code (as per sequence in F11.00 - F11.31) under user-defined mode; it enters next non-factory defaults under non-factory defaults mode.

Press **ESC** to cancel parameter change under the third level menu; If function code is changed to a value as it is, it will exit the third level menu and get back to second level menu; before completing the change, press **ESC** to cancel the change with the original parameter value displayed, and press **ESC** again to exit the third level menu and return to the second level menu. See Figure 4-4 for details.

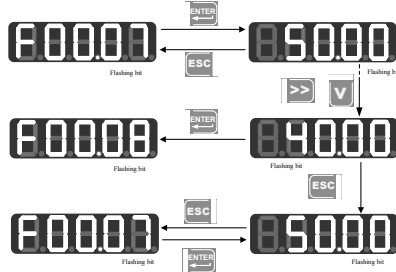

Figure 4-4 Procedure of Cancelling Parameter Change by Pressing ESC

4.2.2 User-Defined Mode (--U--)

When entering function code group F11 from the all menu mode, the third level menu still displays function codes, which can be set as you please. Default display is U00.00 for the first time to enter F11.00, which means that default function code of F11.00 is F00.00; at this time, the lowest cursor bit flickers and user can set any function parameter as in selecting a function code in the second level menu; press **ENTER** to save setting; when entering the user-defined mode, only corresponding function parameters will be shown. For instance, we set F11.00 as U00.07 and set F11.01 as U00.09, i.e., F11.00 and F11.01 are respectively defined as F00.07 and F00.09. Letters U and F are used for distinguishing. U means that the function parameter is user defined. See Figure 4-5 for details.

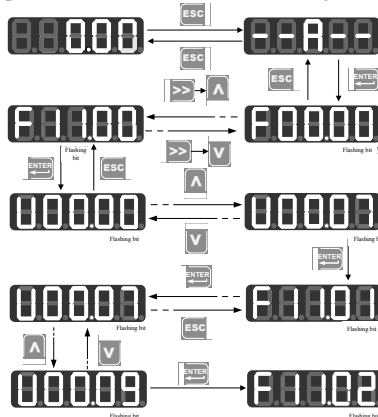

Figure 4-5 Example of User-Defined Mode Setting

displayed value is F00.03; press **▲** to switch to F00.07 and press **▼** to back to F00.03. The following figures will be shown:

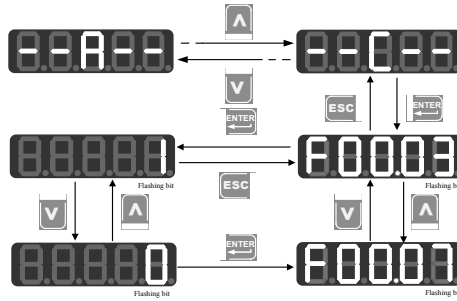

Figure 4-7 Changing Function Parameters under Non-Factory Defaults Mode

4.3 Fault Monitoring

When inverter is in fault state, press **>>** directly to switch among present fault type, fault output frequency, fault output current, fault output voltage, fault control mode and fault working time.

4.4 Operation Monitoring



When the menu displayed is level 0 monitoring menu, press **>>** to switch sequence of 8 monitoring parameters of each function code as per F12.04 - F12.08. If any bit of a function code is set as 1 and confirmed active, user may, through the button, display the value of corresponding monitoring parameter after returning to monitoring menu; otherwise, if the bit is set as 0, the value of corresponding monitoring parameter will not be displayed.

4.5 Parameter Copy

Keypad can upload and download parameters, facilitating users for parameter setting in using inverters of the same function parameters. When setting function code F12.03 as 1 and pressing **ENTER** for confirmation, relevant parameters of inverter are uploaded to keypad with keypad displaying “UP” during uploading; after uploading, function code will change to 0 automatically. Afterwards, keypad can be inserted to other inverters that need the same parameters; set function code F12.03 as 2 for downloading the parameters saved in keypad to inverter, with keypad displaying “DN” during downloading. After downloading, function code will change to 0 automatically.

Special attentions are required for the following:



1. To download parameters from keypad, user must upload parameters at first. Those parameters in keypad without uploading are unknown; downloading such parameters may disorder parameters in inverter and as a result, inverter may break down. Therefore, download parameters without parameter uploading would prompt “No DN”, which indicates that parameters are not downloaded successfully; press **ESC** to exit, and upload and then download these parameters again.

2. If inverters adopt different CPUA software versions, keypad prompts “go on” at the time of downloading parameters. Now, user needs to know whether parameters are available for downloading at these two different versions. If available, user may press  for forced execution; if not, press  to cancel current operation. Uploading and downloading to/from two incompatible inverters may easily cause inverters to fail for operation. Be careful!
3. To use the function, user shall be aware that neither uploading nor downloading involves parameters of motor parameter group and after downloading, user needs to set those parameters before use.

4.6 Function of

There are multiple action modes after pressing . Default action is jog forward. When function code F12.00 changes, the function of this button will change accordingly.

4.7 Run/Stop

Press  after setting parameters and inverter can run normally; press  to stop inverter. By changing function code F12.00 as 5,  will be defined as coast to stop and inverter will stop running.

When function code F01.34 is set as “autotuning” mode, it’s required to press  to make inverter enter the parameter autotuning status; “TUNE” will be shown during parameter autotuning; after completing autotuning, it will be back to the original display and function code F01.34 will change to 0 automatically.

Motor can rotate when inverter is under rotation parameter autotuning. In case of emergency, press  to cancel autotuning.



5 Trial Operation

5.1 Trial Operation Procedure

Follow steps in table 5-1 for trial operation of EM600 inverter.

Table 5-1 Steps of Trial Operation

Step	Description
Installation	Check power of inverter and install inverter as per requirements in Chapter 2.
Inverter Wiring	Wiring as per the requirements in Chapter 3.
Check before Power-on	Verify that input power is connected correctly and input power supply circuit is already connected to circuit breaker; inverter is grounded; power line is connected to inverter power supply input terminals R, S and T; motor is properly connected to output terminals U, V and W of inverter; braking resistor is connected between + and PB; control circuit is properly connected and all limit switches and brake control terminals are connected.
Power-on Check	Check whether there is abnormal sound, foreign odor, fume or the like of inverter. Check whether power indicator is on and whether the operation panel displays normally or there is no fault alarm. In case of fault, please cut the power and check it as per Chapter 9.
Parameter Setting	Macro setting is applied (if any).
Correctly Input Motor Nameplate Parameter	Please input nameplate parameters of motor driven by inverter and check input carefully, otherwise serious problems can occur during running. Set parameters of motor 1 in F01 group. If two motors are used in parallel, then either rated power or rated current shall be the sum of that of two motors. If two motor switches extra motor parameters should be set in F14 group.
Protection Parameter Setting of Motor and Inverter	Properly set inverter and motor limit parameters and protection parameters, mainly including maximum frequency, upper limit frequency and fault output. For hoisting equipment, the following protection settings shall be invalid: current limit protection and overvoltage stall protection.
Motor Parameter Autotuning	Before running for the first time, please conduct motor parameter autotuning, in order to obtain

Step		Description
		correct electrical parameters of controlled motor. If motor load can not be removed, select motor stationary autotuning (F01.34=1/11); afterwards, press  of keypad first and then press  . If motor is still running, Do not conduct motor parameter autotuning operation.
Operation Control Parameter Setting	General Parameter	Correctly set rotational direction, forward/reverse control, acceleration/deceleration time, driving mode, start/stop mode, speed torque control mode and other parameters according to applications of driving system.
	V/F Control	Set function parameters including V/F curve, stator voltage drop compensation and slip compensation, according to load demands.
	Vector Control	Set regulator parameters according to load.
Idling Trial Operation Check		When motor is idling, start inverter at a low speed and check and confirm running status of driving system: Motor: Motor runs stably and rotates normally and correctly; acceleration/deceleration process is normal, free of abnormal vibration, noise and foreign odor. Inverter: Operation panel displays data normally, fan rotates normally and relay acts normally, free from vibration and foreign odor. In case of abnormal condition, immediately stop it and cut the power for checking.
On-Load Trial Operation Check		If inverter has passed no-load operation check satisfactorily, conduct on-load trial operation check. Please correctly connect to braking unit and braking resistor. Check whether inverter runs normally and whether braking acts normally by switching forward and reverse. Observe whether inverter outputs corresponding frequency through master controller's sending of speed signal. Independent braking unit: please observe whether braking unit work light flickers.
Normal Operation	Basic Operation	
	Performance Setting	S Curve Acceleration/Deceleration
		In case of any fault, please check whether input and start/stop function codes are correctly set. Often used for occasions of high-inertia drive system and occasions sensitive to acceleration to reduce mechanic shock and avoid system vibration.

Step		Description
	DC Braking	Input DC current to motor before start or stop, in order to generate the braking torque and thus rapidly stop the rotating motor.
	Special Terminal Control	With multiple multi-function input and output ports, EM600 can offer various kinds of application solutions when in use with external controller.



1. It's strongly recommended to execute keypad operation if terminal or communication control is applied.
2. Inverter can be used normally only after it has passed the idle trial operation and the full-load trial operation.

5.2 Attentions for Trial Operation

5.2.1 Turn on the Power Switch

Before turning on power switch, please confirm the following items:

- Correct power voltage: 3-phase AC380 - 415V, 50Hz; 3-phase AC660 - 690V, 50Hz
- Input power cable is connected to inverter's output terminals R, S and T.
- Inverter's output terminals U, V and U are connected to motor's input terminals.
- Control circuit terminals are correctly connected to the control devices and terminals are disconnected.
- Load motor is idle.
- Turn on power switch when settings above are correct.
- $\oplus\ominus$ are output ends of inverter's DC bus voltage; \ominus represents protective grounding terminal and PB represents cable end of braking resistor. Damages of inverter caused by incorrect wiring of them are not covered in the warranty.

5.2.2 Confirm Power-on Status

If inverter works normally after power-on, keypad will display inverter's present status code and parameters. In case of other abnormal display phenomena, see Chapter 9 Troubleshooting.

- Running status observation:
 1. Check whether load runs at a correct direction.
 2. At low-speed running, increase set frequency only when load machine stabilizes.
 3. Change input frequency or rotational speed and observe whether motor has any vibration or noise.
 4. During operation, observe parameters of monitoring code F18.06 and confirm whether inverter output current is normal.

6 Function Code Table

6.1 Parameter Description

EM600 inverter has 22 groups of function codes as shown in Table 6–1, each group having multiple function codes. F18 is a monitoring parameter group and used for viewing inverter status; F19 is a fault record group and used for viewing three latest faults; other groups are parameter setting groups and used for setting different functions.

Table 6–1 Introduction of Parameters

F00	Basic Function Parameter Group	F01	Motor 1 Parameter
F02	Input Terminal Function Group	F03	Output Terminal Function Group
F04	Start/Stop Control Parameter Group	F05	V/F Control Parameter Group
F06	Vector Control Parameter Group	F07	Protection Function Setting Group
F08	Preset Speed and Simple PLC	F09	PID Function Group
F10	Communication Function Group	F11	User-Defined Parameter Group
F12	Keypad and Display Function Group	F13	Torque Control Parameter Group
F14	Motor 2 Parameter Group	F15	Auxiliary Function Group
F16	Customized Function Group	F17	Virtual I/O Function Group
F18	Monitoring Parameter Group	F19	Fault Record Group
F30	Position Control Group		

★ Note: If some parameters of EM600 are not used, 0 is returned after read; if user retains some options of some parameters, these options can be set, but may result in abnormal running of inverter. Please prevent incorrect operation of these parameters.

The table below describes all items of function code table:

Function Code	F00.00 - F99.99: Numbering of function codes					
Name of Function Code	Complete names of function codes. “Not Used” means that this function code will be retained temporarily, without actual meaning.					
Parameter Description	Brief Parameter Description.					
	Overall	The value of the whole function code represents present parameter selection or meaning.				
	Decimal Digit	Represents some options or present meaning of present function code.				
	Binary digit	Each binary digit represents some options or present meaning of present function codes				
Unit	Metric unit of function codes. Their units and abbreviations are as follows:					
	Hz	Hertz	kW	Kilowatt	us	Microsecond
	kHz	Kilohertz	kWh	Kilowatt-hour ★	ms	Millisecond
	%	Percentage★	MWh	Megawatt hour	s	Second
	V	Volt	mΩ	Milliohm	min	Minute

	A	Ampere	mH	Millihenry	h	Hour
	rpm	Revolutions per minute	°C	Degree Celsius	m	Meter
★ %: Its benchmarks are different depending upon different physical quantities; kWh: kilowatt-hour.						
Default	Factory defaults of function codes or reset to the defaults (F12.14=1).					
	In figures (for example 50.00)	For various power segments, present values of function codes are the default values.				
	Model	For different power segments, function codes have different defaults.				
	XXX	For different power segments or batches, function codes have different defaults.				
Property	Property change of function codes (whether change is permitted and applications for change)					
	●	Can be changed while inverter is running; present function code can be changed regardless of status of inverter.				
	○	Can not be changed while inverter is running; present function code can be changed except running status.				
	×	Read only: property of present function code can not be changed under any status.				

6.2 Function Parameter Table

Function Code	Name of Function Code	Parameter Description	Unit	Default	Property
F00	Basic Function Parameter Group				
F00.00	Not Used				
F00.01	Drive Control Mode of Motor 1	0: V/F control (VVF) 1: Sensorless Vector Control (SVC) 2: Feedback Vector Control (FVC)		0	○
F00.02	Command Source Options	0: Keypad Control (LOC/REM indicator on) 1: Terminal Control (LOC/REM indicator off) 2: Communication Control (LOC/REM indicator flickers)		0	○
F00.03	Terminal Control Mode Options	0: Terminal RUN for running, Forward/Reverse (F/R) 1: Terminal RUN for forward, F/R reverse 2: Terminal RUN for forward, Xi stop, F/R reverse 3: Terminal RUN for running, Xi stop Forward/Reverse (F/R)		0	○
F00.04	Main Frequency	0: Numeric frequency setting		0	○

Function Code	Name of Function Code	Parameter Description	Unit	Default	Property
	Source A Options	F00.07 1: AI1 2: AI2 3: AI3 4: AI4 (Expansion Card) 5: High-Frequency Pulse Input (X7) 6: Main Frequency Communication Percentage Setting 7: Main Frequency Communication Direct Setting			
F00.05	Auxiliary Frequency Source A Options	0: Numeric frequency setting F00.07 1: AI1 2: AI2 3: AI3 4: AI4 (Expansion Card) 5: High-Frequency Pulse Input (X7) 6: Auxiliary Frequency Communication Percentage Setting 7: Auxiliary Frequency Communication Direct Setting 8 - 9: Not Used 10: Process PID 11: Simple PLC		0	○
F00.06	Frequency Source Options	0: Main Frequency Source A 1: Auxiliary Frequency Source B 2: Main and Auxiliary Arithmetic Results 3: Switching between Main Frequency Source A and Auxiliary Frequency Source B 4: Switching between Main Frequency Source A and Main & Auxiliary Arithmetic Results 5: Switching between Auxiliary Frequency Source B and Main & Auxiliary Arithmetic Results		0	○
F00.07	Numeric Frequency Setting	0.00 Hz - Maximum Frequency F00.16	Hz	50.00	●
F00.08	Main and Auxiliary Arithmetic	0: Main Frequency Source A + Auxiliary Frequency Source B		0	○

Function Code	Name of Function Code	Parameter Description	Unit	Default	Property
		1: Main Frequency Source A - Auxiliary Frequency Source B 2: The Bigger of Main A and Auxiliary B 3: The Smaller of Main A and Auxiliary B			
F00.09	Reference Option for Auxiliary Frequency Source B at Main and Auxiliary Arithmetic	0: Relative to Maximum Frequency 1: Relative to Main Frequency Source A		0	○
F00.10	Main Frequency Source Gain	0.0 - 300.0	%	100.0	●
F00.11	Auxiliary Frequency Source Gain	0.0 - 300.0	%	100.0	●
F00.12	Synthetic Gain of Main and Auxiliary Frequency	0.0 - 300.0	%	100.0	●
F00.13	Analog Quantity Adjustment of Synthetic Frequency	0: Synthetic Frequency of Main and Auxiliary Channels 1: A11 * Synthetic Frequency of Main and Auxiliary Channels 2: A12 * Synthetic Frequency of Main and Auxiliary Channels 3: A13 * Synthetic Frequency of Main and Auxiliary Channels 4: A14 * Synthetic Frequency of Main and Auxiliary Channels 5: High-Frequency Pulse (PULSE) * Synthetic Frequency of Main and Auxiliary Channels		0	○
F00.14	Acceleration Time 1	0.00 - 650.00 (F15.13=0) 0.0 - 6500.0 (F15.13=1) 0 - 65000 (F15.13=2)	s	15.00	●
F00.15	Deceleration Time 1	0.00 - 650.00 (F15.13=0) 0.0 - 6500.0 (F15.13=1) 0 - 65000 (F15.13=2)	s	15.00	●
F00.16	Maximum Frequency	1.00 - 600.00	Hz	50.00	○
F00.17	Upper Limit Frequency Control Options	0: Set through F00.18 1: A11 2: A12 3: A13 4: A14 (Expansion Card) 5: High-Frequency Pulse Input (X7) 6: Communication Percentage		0	○

Function Code	Name of Function Code	Parameter Description	Unit	Default	Property
		Setting 7: Communication Direct Setting			
F00.18	Upper Limit Frequency	Lower Limit Frequency F00.19 - Maximum Frequency F00.16	Hz	50.00	●
F00.19	Lower Limit Frequency	0.00 - Upper Limit Frequency F00.18	Hz	0.00	●
F00.20	Running	0: Same; 1: Opposite		0	●
F00.21	Reverse Control	0: permit forward/reverse 1: prohibit reverse		0	○
F00.22	F/R Deadband Time	0.00 - 650.00	s	0.00	●
F00.23	Carrier Frequency	1.0 - 16.0 (inverter rated power < 4.00 kW) 1.0 - 10.0 (inverter rated power 5.50 - 7.50 kW) 1.0 - 8.0 (inverter rated power 11.00 - 45.00 kW) 1.0 - 4.0 (inverter rated power 55.00 - 90.00 kW) 1.0 - 3.0 (inverter rated power 110.00 - 560.00 kW)	kHz	8.0-2.0	●
F00.24	Automatic Adjustment of Carrier Wave	0: Disabled 1: Enabled		1	○
F00.25	Carrier Frequency Noise Suppression	0: Disabled 1: Enabled		0	○
F00.26	Noise Suppression Tone	20 - 200	Hz	40	●
F00.27	Noise Suppression Intensity	10 - 150	Hz	100	●
F00.28	Motor Parameter Group Options	0: Motor 1 Parameter 1: Motor 2 Parameter		0	○
F00.29	User Password	0 - 65535		0	○
F01	Motor 1 Parameter				
F01.00	Motor Type	0: Induction Motor 1: Inverter Induction Motor 2: Permanent Magnet Synchronous Motor		0	○
F01.01	Motor Rated Power	0.10 - 650.00	kW	Up To Specific Model	○
F01.02	Motor Rated Voltage	50 - 2000	V	Up To Specific Model	○

Function Code	Name of Function Code	Parameter Description	Unit	Default	Property
F01.03	Motor Rated Current	0.01 - 600.00 (Motor Rated Power \leq 75 kW) 0.1 - 6000.0 (Motor Rated Power > 75 kW)	A	Up To Specific Model	○
F01.04	Motor Rated Frequency	0.01 - 600.00	Hz	Up To Specific Model	○
F01.05	Motor Rated Speed	1 - 60000	rpm	Up To Specific Model	○
F01.06	Motor Winding Connection	0: Y 1: Δ		Up To Specific Model	○
F01.07	Motor Rated Power Factor	0.600 - 1.000		Up To Specific Model	○
F01.08	Motor Efficiency	30.0 - 100.0	%	Up To Specific Model	○
F01.09	Stator Resistor of Induction Motor	1 - 60000 (Motor Rated Power \leq 75kW) 0.1 - 6000.0 (Motor Rated Power > 75kW)	m Ω	Up To Specific Model	○
F01.10	Rotor Resistor of Induction Motor	1 - 60000 (Motor Rated Power \leq 75kW) 0.1 - 6000.0 (Motor Rated Power > 75kW)	m Ω	Up To Specific Model	○
F01.11	Leakage Inductance of Induction Motor	0.01 - 600.00 (Motor Rated Power \leq 75kW) 0.01 - 600.00 (Motor Rated Power > 75kW)	mH	Up To Specific Model	○
F01.12	Mutual Inductance of Induction Motor	0.1 - 6000.0 (Motor Rated Power \leq 75kW) 0.1 - 6000.0 (Motor Rated Power > 75kW)	mH	Up To Specific Model	○
F01.13	Idling Excitation Current of Induction Motor	0.01 - 600.00 (Motor Rated Power \leq 75kW) 0.1 - 6000.0 (Motor Rated Power > 75kW)	A	Up To Specific Model	○
F01.14	Induction Motor Field Weakening Factor 1	10.00 - 100.00	%	87.00	○
F01.15	Induction Motor Field Weakening Factor 2	10.00 - 100.00	%	80.00	○

Function Code	Name of Function Code	Parameter Description	Unit	Default	Property
F01.16	Induction Motor Field Weakening Factor 3	10.00 - 100.00	%	75.00	○
F01.17	Induction Motor Field Weakening Factor 4	10.00 - 100.00	%	72.00	○
F01.18	Induction Motor Field Weakening Factor 5	10.00 - 100.00	%	70.00	○
F01.19	Stator Resistor of Synchronous Motor	1 - 60000 (Motor Rated Power ≤ 75kW) 0.1 - 6000.0 (Motor Rated Power > 75kW)	mΩ	Up To Specific Model	○
F01.20	d-Shaft Inductance of Synchronous Motor	0.01 - 600.00 (Motor Rated Power ≤ 75kW) 0.001 - 60.000 (Motor Rated Power > 75kW)	mH	Up To Specific Model	○
F01.21	q-Shaft Inductance of Synchronous Motor	0.01 - 600.00 (Motor Rated Power ≤ 75kW) 0.001 - 60,000 (Motor Rated Power > 75kW)	mH	Up To Specific Model	○
F01.22	Back Electromotive Force of Synchronous Motor	10.0 - 2000.0 (Back Electromotive Force of Rated Rotation Speed)	V	Up To Specific Model	○
F01.23	Initial Electric Angle of Synchronous Motor	0.0 - 359.9 (Synchronous motor enabled)			○
F01.24	Encoder Type	0: ABZ Incremental Encoder 1: UVW Incremental Encoder 2: UVW Wire-Saving Encoder 3: Not Used 4: Rotary Transformer		0	○
F01.25	Encoder Resolution	1 - 65535		1024	○
F01.26	Phase Angle of Zero Pulse of Encoder	0.0 - 359.9°		0.0	○
F01.27	AB Pulse Phase Sequence	0: Forward 1: Reverse		0	○
F01.28	Phase Sequence of UVW Encoder	0: Forward 1: Reverse		0	○
F01.29	UVW Initial Offset Phase Angle	0.0 - 359.9°		0.0	○
F01.30	Rotary Transformer Pole-Pairs	1 - 65535		1	○
F01.31	Not Used				
F01.32	Speed Feedback Disconnection Detection Time	0.0 - 10.0 (0.0: Speed Feedback Disconnection Detection Disabled)		0.0	○

Function Code	Name of Function Code	Parameter Description	Unit	Default	Property
F01.33	Filter Time of Speed Feedback	0.000 - 0.100	s	0.002	○
F01.34	Motor Parameter Autotuning	0: No Autotuning 1: Stationary Autotuning of Induction Motor 2: Rotational Autotuning of Induction Motor 3: Not Used 11: Stationary Autotuning of Synchronous Motor 12: Rotational Autotuning of Synchronous Motor 13: Autotuning of Encoder of Synchronous Motor		0	○
F02	Input Terminal Function Group				
F02.00	X1 Numeric Input Function	0: No Function 1: Run Terminal “RUN”		1	○
F02.01	X2 Numeric Input Function	2: Direction R/F 3: Wire Sequence Stop Control		2	○
F02.02	X3 Numeric Input Function	4: Forward JOG (FJOG) 5: Reverse JOG (RJOG)		11	○
F02.03	X4 Numeric Input Function	6: Terminal UP 7: Terminal DOWN		12	○
F02.04	X5 Numeric Input Function	8: Clear UP/Down Offset 9: Coast to Stop		13	○
F02.05	X6 Numeric Input Function	10: Fault Reset 11: Preset Speed Terminal 1		14	○
F02.06	X7 Numeric Input Function	12: Preset Speed Terminal 2 13: Preset Speed Terminal 3		10	○
F02.07	AI1 Numeric Input Function	14: Preset Speed Terminal 4 15: Preset PID Terminal 1		0	○
F02.08	AI2 Numeric Input Function	16: Preset PID Terminal 2 17: Preset Torque Terminal 1		0	○
F02.09	AI3 Numeric Input Function	18: Preset Torque Terminal 2 19: Acceleration/Deceleration Time Terminal 1		0	○
F02.10	AI4 Numeric Input Function (Expansion Card)	20: Acceleration/Deceleration Time Terminal 2		0	○
F02.11	X8 Numeric Input Function (Expansion Card)	20: Acceleration/Deceleration Time Terminal 2 22: Pause Operation		0	○
F02.12	X9 Numeric Input Function (Expansion Card)	23: External Fault Input 24: Switch Run Command to		0	○

Function Code	Name of Function Code	Parameter Description	Unit	Default	Property
	Card)	Keypad			
F02.13	X10 Numeric Input Function (Expansion Card)	25: Switch Run Command to Communication 26: Frequency Source Switching		0	○
F02.14	X11 Numeric Input Function (Expansion Card)	27: Clear Timed Run Time 28: Switch between Speed Control and Torque Control		0	○
		29: Torque Control Disabled 30: Switch between Motor 1 and Motor 2 31: Simple PLC Status Reset (Start to Run with Preset Speed 1, Clear Run Time) 32: Simple PLC Time Stop (Keep Running at Present Speed) 33: Zero Servo Command 34: Count Input ($\leq 250\text{Hz}$) 35: High-Speed Count Input ($\leq 100\text{kHz}$, Only Enabled for X7) 36: Counter Clear 37: Length Count Input ($\leq 250\text{Hz}$) 38: High-Speed Length Count Input ($\leq 100\text{kHz}$, Only Enabled for X7) 39: Length Clear 40: Pulse Input ($\leq 100\text{kHz}$, Only Enabled for X7) 41: Process PID Stop 42: Process PID Integral Stop 43: PID Parameter Switch 44: PID Positive/Negative Reaction Switch 45: Stop and DC Brake 46: DC Brake at Stop 47: Immediate DC Brake 48: Fastest Coast-To-Stop 49: Not Used 50: External Stop 51: Switch Main Frequency Source to Numeric Frequency Setting 52: Switch Main Frequency Source to All 53: Switch Main Frequency Source			

Function Code	Name of Function Code	Parameter Description	Unit	Default	Property																
		to AI2 54: Switch Main Frequency Source to AI3 55: Switch Main Frequency Source to High-Frequency Pulse Input 56: Switch Main Frequency Source to Communication Setting 57: Inverter Enabled 58~68 Not Used 69: Reverse Forbidden 70~124: Not Used 125: Spindle Orientation Enable 126: Spindle Orientation Position 0 127: Spindle Orientation Position 1 128: Spindle Orientation Position 2 129: Transmission Gear 0 130: Transmission Gear 1 131: Spindle clamp interlock signal 132: Feed Control Enabled 133: Homing Enabled 134: Feed selection bit 0 135: Feed selection bit 1 136: Feed selection bit 2 137: Original Point input signal 138: Forward Feed 139: Reverse Feed 140: Feed Stepping Increase 141: Feed Stepping Decrease																			
F02.15	Positive/Negative Logic 1 of Numeric Input Terminal	<table border="1"> <tr> <td>D7</td><td>D6</td><td>D5</td><td>D4</td><td>D3</td><td>D2</td><td>D1</td><td>D0</td> </tr> <tr> <td>*</td><td>X7</td><td>X6</td><td>X5</td><td>X4</td><td>X3</td><td>X2</td><td>X1</td> </tr> </table> 0: Positive Logic, Enabled at On/Disabled at Off 1: Negative Logic, Disabled at On/Enabled at Off	D7	D6	D5	D4	D3	D2	D1	D0	*	X7	X6	X5	X4	X3	X2	X1		*00 00000	○
D7	D6	D5	D4	D3	D2	D1	D0														
*	X7	X6	X5	X4	X3	X2	X1														
F02.16	Positive/Negative Logic 2 of Numeric Input Terminal	<table border="1"> <tr> <td>D7</td><td>D6</td><td>D5</td><td>D4</td><td>D3</td><td>D2</td><td>D1</td><td>D0</td> </tr> <tr> <td>X1</td><td>X10</td><td>X9</td><td>X8</td><td>AI4</td><td>AI3</td><td>AI2</td><td>AI1</td> </tr> </table> 0: Positive Logic, Enabled at On/Disabled at Off 1: Negative Logic, Disabled at On/Enabled at Off	D7	D6	D5	D4	D3	D2	D1	D0	X1	X10	X9	X8	AI4	AI3	AI2	AI1		000 00000	○
D7	D6	D5	D4	D3	D2	D1	D0														
X1	X10	X9	X8	AI4	AI3	AI2	AI1														
F02.17	Filter Times of Numeric Input Terminal	0-100, 0 for No Filter, n for sampling once every n ms		2	○																

Function Code	Name of Function Code	Parameter Description	Unit	Default	Property
F02.18	X1 Effective Delay Time	0.000 - 30.000	s	0.000	●
F02.19	X1 Ineffective Delay Time	0.000 - 30.000	s	0.000	●
F02.20	X2 Effective Delay Time	0.000 - 30.000	s	0.000	●
F02.21	X2 Ineffective Delay Time	0.000 - 30.000	s	0.000	●
F02.22	X3 Effective Delay Time	0.000 - 30.000	s	0.000	●
F02.23	X3 Ineffective Delay Time	0.000 - 30.000	s	0.000	●
F02.24	X4 Effective Delay Time	0.000 - 30.000	s	0.000	●
F02.25	X4 Ineffective Delay Time	0.000 - 30.000	s	0.000	●
F02.26	Minimum Input Pulse Frequency	0.00 – Maximum Input Pulse Frequency F02.28	kHz	0.00	●
F02.27	Setting Corresponding to Minimum Input	-100.0 - +100.0	%	0.0	●
F02.28	Maximum Input Pulse Frequency	0.01 - 100.00	kHz	50.00	●
F02.29	Setting Corresponding to Maximum Input	-100.0 - +100.0	%	100.0	●
F02.30	Pulse Input Filter Time	0.00 - 10.00	s	0.10	●
F02.31	Analog Input Function	<p>Ones place: AI1 0: Analog Input 1: Numeric Input (0 for less than 1V, 1 for over 3V, contrary to last time for 1V-3V)</p> <p>Tens place: AI2 0: Analog Input 1: Numeric input (the same as above)</p> <p>Hundreds place: AI3 0: Analog Input 1: Numeric input (the same as above)</p> <p>Thousands Place: AI4 (Expansion Card)</p>		0000D	○

Function Code	Name of Function Code	Parameter Description	Unit	Default	Property
		0: Analog Input 1: Numeric input (the same as above)			
F02.32	Analog Input Curve Options	Ones Place: AI1 Curve 0: Curve 1 1: Curve 2 2: Curve 3 3: Curve 4 Tens Place: AI2 Curve 0: Curve 1 1: Curve 2 2: Curve 3 3: Curve 4 Hundreds Place: AI3 Curve 0: Curve 1 1: Curve 2 2: Curve 3 3: Curve 4 Thousands Place: AI4 Curve 0: Curve 1 1: Curve 2 2: Curve 3 3: Curve 4		3210D	○
F02.33	Minimum Input of Curve 1	0.00 - F02.35	V	0.10	●
F02.34	Setting Corresponding to Minimum Input of Curve 1	-100.0 - +100.0	%	0.0	●
F02.35	Maximum Input of Curve 1	F02.33 - 10.00	V	9.90	●
F02.36	Setting Corresponding to Maximum Input of Curve 1	-100.0 - +100.0	%	100.0	●
F02.37	Minimum Input of Curve 2	-10.00 - F02.39	V	0.10	●
F02.38	Setting	-100.0 - +100.0	%	0.0	●

Function Code	Name of Function Code	Parameter Description	Unit	Default	Property
	Corresponding to Minimum Input of Curve 2				
F02.39	Maximum Input of Curve 2	F02.37 - 10.00	V	9.90	●
F02.40	Setting Corresponding to Maximum Input of Curve 2	-100.0 - +100.0	%	100.0	●
F02.41	Minimum Input of Curve 3	0.00 - F02.43	V	0.10	●
F02.42	Setting Corresponding to Minimum Input of Curve 3	-100.0 - +100.0	%	0.0	●
F02.43	Input of Inflexion 1 of Curve 3	F02.41 - F02.45	V	2.50	●
F02.44	Setting Corresponding to Input of Inflexion 1 of Curve 3	-100.0 - +100.0	%	25.0	●
F02.45	Input of Inflexion 2 of Curve 3	F02.43 - F02.47	V	7.50	●
F02.46	Setting Corresponding to Input of Inflexion 2 of Curve 3	-100.0 - +100.0	%	75.0	●
F02.47	Maximum Input of Curve 3	F02.45 - 10.00	V	9.90	●
F02.48	Setting Corresponding to Maximum Input of Curve 3	-100.0 - +100.0	%	100.0	●
F02.49	Minimum Input of Curve 4	-10.00 - F02.51	V	-9.90	●
F02.50	Setting Corresponding to Minimum Input of Curve 4	-100.0 - +100.0	%	-100.0	●
F02.51	Input of Inflexion 1 of Curve 4	F02.49 - F02.53	V	-5.00	●
F02.52	Setting Corresponding to Input of Inflexion 1	-100.0 - +100.0	%	-50.0	●

Function Code	Name of Function Code	Parameter Description	Unit	Default	Property
	of Curve 4				
F02.53	Input of Inflexion 2 of Curve 4	F02.51 - F02.55	V	5.00	●
F02.54	Setting Corresponding to Input of Inflexion 2 of Curve 4	-100.0 - +100.0	%	50.0	●
F02.55	Maximum Input of Curve 4	F02.53 - 10.00	V	9.90	●
F02.56	Setting Corresponding to Maximum Input of Curve 4	-100.0 - +100.0	%	100.0	●
F02.57	AI1 Filter Time	0.00 - 10.00	s	0.10	●
F02.58	AI2 Filter Time	0.00 - 10.00	s	0.10	●
F02.59	AI3 Filter Time	0.00 - 10.00	s	0.10	●
F02.60	AI4 Filter Time (Expansion Card)	0.00 - 10.00	s	0.10	●
F02.61	AD Sampling Hysteresis	2 - 50		2	○
F03	Output Terminal Function Group				
F03.00	Y1 Output	0: No Output 1: Inverter Running (RUN) 2: Frequency Reach Range (FAR) 3: Output Frequency Detection Range FDT1 4: Output Frequency Detection Range FDT2 5: Reverse running (REV) 6: Jogging 7: Inverter Fault 8: Inverter Ready 9: Upper Limit Frequency Reach 10: Lower Limit Frequency Reach 11: Current Limit Enabled 12: Overvoltage Stall Voltage Reach 13: Simple PLC Cycle Finished 14: Set Count Value Reach 15: Designated Count Value Reach 16: Length Reach 17: Motor Overload Pre-alarming 18: Inverter Overheating Pre-Alarming		1	○
F03.01	Y2 Output			3	○
F03.02	R1 Output (EA-EB-EC)			7	○
F03.03	R2 Output (RA-RB-RC)			8	○
F03.04	Y3 Output (expansion card)			0	○

Function Code	Name of Function Code	Parameter Description	Unit	Default	Property																
		19: PID Feedback Upper Limit Reach 20: PID Feedback Lower Limit Reach 21: Analog Quantity Level Detection ADT1 22: Analog Quantity Level Detection ADT2 23: Zero Servo 24: Undervoltage Status 25: Motor Overload Pre-alarmed 26: Set Time Reach 27: Run at Zero Speed 28 - 35: Not Used 36: Position Fix 37 - 68: Not Used 69: FDT1 Lower Limit Frequency (Pulse) 70: FDT2 Lower Limit Frequency (Pulse) 71: FDT1 Lower Limit Frequency (Pulse, Disabled when JOG) 72: FDT2 Lower Limit Frequency (Pulse, Disabled when JOG)																			
F03.05	Output Signal Type	<table border="1"> <tr> <td>D7</td><td>D6</td><td>D5</td><td>D4</td><td>D3</td><td>D2</td><td>D1</td><td>D0</td> </tr> <tr> <td>*</td><td>*</td><td>*</td><td>*</td><td>R2</td><td>R1</td><td>Y2</td><td>Y1</td> </tr> </table> 0: Level 1: Monopulse	D7	D6	D5	D4	D3	D2	D1	D0	*	*	*	*	R2	R1	Y2	Y1		*0000	○
D7	D6	D5	D4	D3	D2	D1	D0														
*	*	*	*	R2	R1	Y2	Y1														
F03.06	Positive/Negative Logic of Numeric Output	<table border="1"> <tr> <td>D7</td><td>D6</td><td>D5</td><td>D4</td><td>D3</td><td>D2</td><td>D1</td><td>D0</td> </tr> <tr> <td>*</td><td>*</td><td>*</td><td>Y3</td><td>R2</td><td>R1</td><td>Y2</td><td>Y1</td> </tr> </table> 0: Positive Logic, Enabled at On/Disabled at Off 1: Negative Logic, Disabled at On/Enabled at Off	D7	D6	D5	D4	D3	D2	D1	D0	*	*	*	Y3	R2	R1	Y2	Y1		00000	○
D7	D6	D5	D4	D3	D2	D1	D0														
*	*	*	Y3	R2	R1	Y2	Y1														
F03.07	Y2 Output Type	0: Common Numeric Output 1: High-Frequency Pulse Output		0	○																
F03.08	Output Status Control at JOG	<table border="1"> <tr> <td>D7</td><td>D6</td><td>D5</td><td>D4</td><td>D3</td><td>D2</td><td>D1</td><td>D0</td> </tr> <tr> <td>*</td><td>*</td><td>*</td><td>REV</td><td>FD T2</td><td>FDT1</td><td>FA R</td><td>RU N</td> </tr> </table> 0: Enabled at JOG 1: Disabled at JOG	D7	D6	D5	D4	D3	D2	D1	D0	*	*	*	REV	FD T2	FDT1	FA R	RU N		00000	○
D7	D6	D5	D4	D3	D2	D1	D0														
*	*	*	REV	FD T2	FDT1	FA R	RU N														
F03.09	Y1 Effective Delay Time	0.000 - 30.000	s	0.000	●																
F03.10	Y1 Ineffective Delay	0.000 - 30.000	s	0.000	●																

Function Code	Name of Function Code	Parameter Description	Unit	Default	Property
	Time				
F03.11	Y2 Effective Delay Time	0.000 - 30.000	s	0.000	●
F03.12	Y2 Ineffective Delay Time	0.000 - 30.000	s	0.000	●
F03.13	R1 Effective Delay Time	0.000 - 30.000	s	0.000	●
F03.14	R1 Ineffective Delay Time	0.000 - 30.000	s	0.000	●
F03.15	R2 Effective Delay Time	0.000 - 30.000	s	0.000	●
F03.16	R2 Ineffective Delay Time	0.000 - 30.000	s	0.000	●
F03.17	Y1 Monopulse Output Time	0.000 - 30.000	s	0.250	●
F03.18	Y2 Monopulse Output Time	0.000 - 30.000	s	0.250	●
F03.19	R1 Monopulse Output Time	0.000 - 30.000	s	0.250	●
F03.20	R2 Monopulse Output Time	0.000 - 30.000	s	0.250	●
F03.21	Analog Output M1	0: Running Frequency (absolute value) 1: Set Frequency (absolute value) 2: Output torque (absolute value) 3: Set Torque (absolute value) 4: Output Current 5: Output Voltage 6: Bus voltage 7: Output power 8: AI1 9: AI2 10: AI3 11: AI4 (Expansion Card) 12: High-Frequency Pulse Input (100.00% Corresponding to Maximum Frequency, 0.00% Corresponding to Minimum Frequency) 13: Not Used 14: Value of Count 15: Value of Length 16-29: Not Used		0	○
F03.22	Analog Output M2			2	○
F03.23	Y2 High-Frequency Pulse Output Function			11	○
F03.24	100% Frequency of	0.00 - 100.00	kHz	50.00	●

Function Code	Name of Function Code	Parameter Description	Unit	Default	Property
	Y2 High-Frequency Pulse Output				
F03.25	0% Frequency of Y2 High-Frequency Pulse Output	0.00 - 100.00	kHz	0.00	●
F03.26	Filter Time of Y2 High-Frequency Pulse Output	0.00 - 10.00	s	0.10	●
F03.27	M1 Output Offset	-100.0 - 100.0	%	0.0	●
F03.28	M1 Output Gain	-10.00 - 10.00		1.00	●
F03.29	M2 Output Offset	-100.0 - 100.0	%	0.0	●
F03.30	M2 Output Gain	-10.00 - 10.00		1.00	●
F04	Start/Stop Control Parameter Group				
F04.00	Start Mode	0: Start Directly 1: Rotation Speed Tracking Start		0	○
F04.01	Start Frequency	0.00 - 10.00	Hz	0.00	○
F04.02	Start Frequency Retention time	0.00 - 60.00, Disabled at 0.00	s	0.00	○
F04.03	DC Brake Current at Start	0.0 - 100.0 (100.0= Inverter Rated Frequency)	%	100.0	○
F04.04	DC Brake Time at Start	0.00 - 30.00	s	0.00	○
F04.05	DC Brake Field Weakening Time at Start	0.00 - 30.00	s	0.50	○
F04.06	Pre-Excitation Current	50.0 - 500.0 (100.0=Idling Current)	%	100.0	○
F04.07	Pre-Excitation	0.00 - 10.00	s	0.10	○
F04.08	Rotation Speed Tracking Method	0: Start from Maximum Frequency 1: Start from Stop Frequency 2: Start from Grid Frequency		0	○
F04.09	Not Used	-	-	-	-
F04.10	Deceleration Time of Rotation Speed Tracking	0.1 - 20.0	s	2.0	○
F04.11	Rotation Speed Tracking Current	30.0 - 150.0 (100.0=Rated Current)	%	60.0	●
F04.12	Rotation Speed Compensation Gain	1.00 - 1.30		1.05	●
F04.13	Not Used	-	-	-	-
F04.14	Acceleration/Deceleration Mode	0: Linear Acceleration/Deceleration 1: S Curve Acceleration/Deceleration		0	○

Function Code	Name of Function Code	Parameter Description	Unit	Default	Property
F04.15	S Curve Start Section Time at Acceleration	0.00 - System acceleration time/2 (F15.13=0) 0.0 - System acceleration time/2 (F15.13=1) 0 - System acceleration time/2 (F15.13=2)	s	1.00	●
F04.16	S Curve End Section Time at Acceleration	0.00 - System acceleration time/2 (F15.13=0) 0.0 - System acceleration time/2 (F15.13=1) 0 - System acceleration time/2 (F15.13=2)	s	1.00	●
F04.17	S Curve Start Section Time at Deceleration	0.00 - System deceleration time/2 (F15.13=0) 0.0 - System deceleration time/2 (F15.13=1) 0 - System deceleration time/2 (F15.13=2)	s	1.00	●
F04.18	S Curve End Section Time at Deceleration	0.00 - System deceleration time/2 (F15.13=0) 0.0 - System deceleration time/2 (F15.13=1) 0 - System deceleration time/2 (F15.13=2)	s	1.00	●
F04.19	Stop Mode	0: Ramp-To-Stop 1: Coast-to-Stop 2: Spindle Orientation Enable When Terminal for Running is Disabled		0	○
F04.20	DC Brake Start Frequency at Stop	0.00 - Maximum Frequency F00.16	Hz	0.00	○
F04.21	DC Brake Current at Stop	0.0 - 150.0 (100.0= Motor Rated Current)	%	100.0	○
F04.22	DC Brake Time at Stop	0.00 - 30.00, Disabled at 0.00	s	0.00	○
F04.23	DC Brake Field Weakening Time at Stop	0.00 - 30.00	s	0.50	○
F04.24	Magnetic Flux Brake Gain	100 – 150 (100: No Magnetic Flux Brake)		100	○
F04.25	Not Used				
F04.26	Start Mode after Fault/Coast to Stop	0: Start as per the Set Mode of F04.00 1: Rotation Speed Tracking Start		0	○

Function Code	Name of Function Code	Parameter Description	Unit	Default	Property
F04.27	Terminal Start Command Reconfirmation	0: Not to Confirm 1: Confirm		0	○
F04.28	Not Used	-	-	-	-
F04.29	Zero Frequency	0.00 - 5.00	Hz	0.25	●
F04.30	Initial Position Search after Power-on or Fault	0: Disabled 1: Enabled		0	●
F05	V/F Control Parameter Group				
F05.00	V/F Curve Setting	0: Straight V/F 1: Multi-Dot Polyline V/F 2: VF to the 1.3 rd 3: VF to the 1.7 th 4: Square V/F 5: VF Complete Split Mode (Ud=0, Uq=K*t=Split voltage source voltage) 6: VF Half-Split Mode (Ud=0, Uq=K*t=F/Fe*2*Split voltage source voltage)		0	○
F05.01	Multipoint VF Frequency Point F1	0.00 - F05.03	Hz	0.50	●
F05.02	Multipoint VF Voltage Point V1	0.0 - 100.0 (100.0= Motor Rated Voltage)	%	1.0	●
F05.03	Multipoint VF Frequency Point F2	F05.01 - F05.05	Hz	2.00	●
F05.04	Multipoint VF Voltage Point V2	0.0 - 100.0	%	4.0	●
F05.05	Multipoint VF Frequency Point F3	F05.03 - Motor Rated Frequency (Reference Frequency)	Hz	5.00	●
F05.06	Multipoint VF Voltage Point V3	0.0 - 100.0	%	10.0	●
F05.07	Voltage Source of VF Separation Mode	0: Numeric Setting of VF Separation Voltage 1: AI1 2: AI2 3: AI3 4: High-Frequency Pulse (X7) 5: PID 6: Communication Setting Note: Motor Rated Voltage is 100%.		0	○
F05.08	Numeric Setting of VF Separation Voltage	0.0 - 100.0 (100.0= Motor Rated Voltage)	%	0.0	●

Function Code	Name of Function Code	Parameter Description	Unit	Default	Property
F05.09	Voltage Rise Time of VF Separation	0.00 - 60.00	s	2.00	●
F05.10	V/F Rotor Voltage Drop Compensation Gain	0.00 - 200.00	%	100.00	●
F05.11	V/F Slip Compensation Gain	0.00 - 200.00	%	100.00	●
F05.12	V/F Slip Filter Time	0.00 - 10.00	s	1.00	●
F05.13	Oscillation Suppression Gain	0 - 20000		100	●
F05.14	Oscillation Suppression End Frequency	0.00 - 600.00	Hz	55.00	●
F05.15	Sagging Control Frequency	0.00 - 10.00	Hz	0.00	●
F05.16	Energy Saving Rate	0.00 - 50.00	%	0.00	●
F05.17	Energy Saving Actuation Time	1.00 - 60.00	s	5.00	●
F05.18	Compensation Gain of Magnetic Flux of Synchronous Motor	0.00 - 500.00	%	100.00	●
F05.19	Filter Time Constant of Magnetic Flux Compensation of Synchronous Motor	0.00 - 10.00	s	0.50	●
F06	Vector Control Parameter Group				
F06.00	Speed Proportional Gain ASR_P1	0.00 - 100.00		12.00	●
F06.01	Speed Integral Time Constant ASR_T1	0.000 - 30.000 0.000: No Integral	s	0.200	●
F06.02	Speed Proportional Gain ASR_P2	0.00 - 100.00		8.00	●
F06.03	Speed Integral Time Constant ASR_T2	0.000 - 30.000 0.000: No Integral	s	0.300	●
F06.04	Switching Frequency 1	0.00 - Switching Frequency 2	Hz	5.00	●
F06.05	Switching Frequency 2	Switching Frequency 1 - Maximum Frequency F00.16	Hz	10.00	●
F06.06	Velocity Loop Anti-Saturation Factor	0.000 - 1.000		0.500	●
F06.07	Time Constant of Output Filter of Velocity Loop	0.000 - 0.100	s	0.001	●

Function Code	Name of Function Code	Parameter Description	Unit	Default	Property
F06.08	Vector Control Slip Gain	10.00 - 200.00	%	100.00	●
F06.09	Speed Control Torque Limit Source Selection	0: F06.10 and F06.11 1: AI1 2: AI2 3: AI3 4: AI4 (Expansion Card) 5: Communication (Percentage) 6: Maximum of AI2 and AI3 7: Minimum of AI2 and AI3		0	○
F06.10	Upper Limit of JOG for Speed Control	0.0 - 250.0	%	165.0	●
F06.11	Upper Limit of Brake Torque for Speed Control	0.0 - 250.0	%	165.0	●
F06.12	Excitation Current Proportional Gain ACR-P1	0.00 - 100.00		0.50	●
F06.13	Excitation Current Integral Time Constant ACR-T1	0.00 - 600.00 0.00: No Integral	ms	10.00	●
F06.14	Torque Current Proportional Gain ACR-P2	0.00 - 100.00		0.50	●
F06.15	Torque Current Integral Time Constant ACR-T2	0.00 - 600.00 0.00: No Integral	ms	10.00	●
F06.16	Not Used	-	-	-	-
F06.17	SVC Zero Frequency Processing Method	0: Brake 1: Normal 2: No Output		2	○
F06.18	SVC Zero Frequency Band-Type Brake Current	50.0 - 400.0 (100.0=Idling Current)	%	100.0	○
F06.19	Not Used	-	-	-	-
F06.20	Voltage Feedforward Gain	0 - 100	%	0	●
F06.21	Field Weakening Control Options	0: Disabled 1: Direct Calculation 2: Automatic Adjustment		2	○

Function Code	Name of Function Code	Parameter Description	Unit	Default	Property
F06.22	Field Weakening Voltage	70.00 - 200.00	%	95.00	●
F06.23	Maximum Field Weakening Current of Synchronous Motor	0.0 - 150.0 (100.0= Motor Rated Current)	%	50.0	●
F06.24	Proportional Gain of Field Weakening Regulator	0.00 - 10.00		0.50	●
F06.25	Integral Time of Field Weakening Regulator	0.01 - 60.00	s	2.00	●
F06.26	MTPA Control Options of Synchronous Motor	0: Disabled 1: Enabled		0	○
F06.27	Gain of Autotuning at Initial Position	0 - 600	%	80	●
F06.28	Injection Current at Frequency of Low Frequency Range	0.00 - 100.00 (100.00= Motor Rated Frequency)	%	10.00	●
F06.29	Injection Current at Low Frequency Range	0.0 - 60.0 (100.0= Motor Rated Current)	%	20.0	●
F06.30	Low Frequency Range Regulator Gain of Injection Current	0.00 - 10.00		0.50	●
F06.31	Integral Time of Low Frequency Range Regulator of Injection Current	0.00 - 300.00	ms	10.00	●
F06.32	Injection Current at Frequency of High Frequency Range	0.00 - 100.00 (100.00.0= Motor Rated Frequency)	%	20.00	●
F06.33	Injection Current at High Frequency Range	0.0 - 30.0 (100.0= Motor Rated Current)	%	8.0	●
F06.34	High Frequency Range Regulator Gain of Injection	0.00 - 10.00		0.50	●

Function Code	Name of Function Code	Parameter Description	Unit	Default	Property								
	Current												
F06.35	Integral Time of High Frequency Range Regulator of Injection Current	0.00 - 300.00	ms	10.00	●								
F06.36	Current Loop Proportional Gain of Synchronous Motor	10.00 – 600.00	%	100.00	○								
F06.37	Current Loop Integral Gain of Synchronous Motor	10.00 – 600.00	%	100.00	○								
F06.38 – F06.40	Not Used	-	-	-	-								
F07	Protection Function Setting Group												
F07.00	Protection Shield	<table border="1" style="display: inline-table; vertical-align: middle;"> <tr> <td>-</td> <td>E22</td> <td>E13</td> <td>SLU</td> <td>SDU</td> <td>SDC</td> <td>ILP</td> <td>GLP</td> </tr> </table> 0: Valid Protection 1: Protection Shielded	-	E22	E13	SLU	SDU	SDC	ILP	GLP		000 00000	○
-	E22	E13	SLU	SDU	SDC	ILP	GLP						
F07.01	Motor Overload Protection Gain	0.20 - 10.00		1.00	●								
F07.02	Motor Overload Pre-Alarming Factor	50 - 100	%	80	●								
F07.03	Motor Temperature Sensor Type	0: No Temperature Sensor 1: PT100 2: PT1000		0	●								
F07.04	Motor Overheating Protection Threshold	0 - 200	℃	110	●								
F07.05	Motor Overheating Pre-Alarming Threshold	0 - 200	℃	90	●								
F07.06	Bus Voltage Control Options	0: Disabled 1: Undervoltage Stall, Enabled 2: Overvoltage Stall, Enabled 3: Overvoltage Stall and Undervoltage Stall, Enabled		2	○								
F07.07	Overvoltage Stall Control Voltage	110.0 - 150.0 (380V, 100.0=537V)	%	128.5	●								
F07.08	Undervoltage Stall Control Voltage	60.0 - Judgment Operation Voltage at Power Failure Ending (100.0= Standard Bus Voltage)	%	76.0	●								
F07.09	Judgment Operation Voltage at Power Failure Ending	Undervoltage Stall Control Voltage - 100.0	%	86.0	●								

Function Code	Name of Function Code	Parameter Description	Unit	Default	Property
F07.10	Judgment Delay Time at Power Failure Ending	0.00 - 100.00	s	5.00	●
F07.11	Current Limit Control	0: Disabled 1: Limit Mode 1 2: Limit Mode 2		2	○
F07.12	Current Limit Level	20.0 - 180.0 (100.0= Inverter Rated Current)	%	150.0	●
F07.13	Rapid Current Limit	0: Disabled 1: Enabled		0	○
F07.14	Fault Retry Times	0 – 20, 0: Fault Retry Disabled		0	○
F07.15	Numeric Output Action at Fault Retry	0: Disabled 1: Enabled		0	○
F07.16	Fault Retry Interval	0.01 - 30.00	s	0.50	●
F07.17	Recovery Time of Fault Retry Times	0.01 - 30.00	s	10.00	●
F07.18	Fault Retry	<small>ILP HQU HOC SLU SQU SOC</small> 0: Permitted 1: Not Permitted		**0 00000	○
F07.19	Action 1 at Fault	<small>E21 E16 E15 E14 E13 E12 GLP ILP</small> 0: Coast to Stop 1: Stop as per the Set Stop Mode		000 00000	○
F07.20	Action 2 at Fault	<small>E28 E27 E25 E23</small> 0: Coast to Stop 1: Stop as per the Set Stop Mode		*0000	○
F07.21	Offload Protection	0: Disabled 1: Enabled		0	●
F07.22	Offload Detection Level	0.0 - 100.0	%	20.0	●
F07.23	Load Detection Time	0.0 - 60.0	s	1.0	●
F07.24	Offload Protection	0: Coast to Stop 1: Stop as per the Set Stop Mode		1	○
F07.25	Motor Overspeed Detection Level	0.0 - 50.0 (reference frequency is Maximum Frequency F00.16)	%	20.0	●
F07.26	Motor Overspeed Detection Time	0.0 - 60.0, 0.0: cancel motor overspeed protection	s	1.0	●
F07.27	AVR	0: Disabled 1: Enabled		1	○
F07.28	Stalling Fault Detection Time	0.0 – 6000.0 (0.0 stalling fault is disabled)	s	60.0	○
F08	Preset Speed and Simple PLC				
F08.00	Preset Speed 1	0.00 - Maximum Frequency F00.16	Hz	0.00	●

Function Code	Name of Function Code	Parameter Description	Unit	Default	Property
F08.01	Preset Speed 2	0.00 - Maximum Frequency F00.16	Hz	5.00	●
F08.02	Preset Speed 3	0.00 - Maximum Frequency F00.16	Hz	10.00	●
F08.03	Preset Speed 4	0.00 - Maximum Frequency F00.16	Hz	15.00	●
F08.04	Preset Speed 5	0.00 - Maximum Frequency F00.16	Hz	20.00	●
F08.05	Preset Speed 6	0.00 - Maximum Frequency F00.16	Hz	25.00	●
F08.06	Preset Speed 7	0.00 - Maximum Frequency F00.16	Hz	30.00	●
F08.07	Preset Speed 8	0.00 - Maximum Frequency F00.16	Hz	35.00	●
F08.08	Preset Speed 9	0.00 - Maximum Frequency F00.16	Hz	40.00	●
F08.09	Preset Speed 10	0.00 - Maximum Frequency F00.16	Hz	45.00	●
F08.10	Preset Speed 11	0.00 - Maximum Frequency F00.16	Hz	50.00	●
F08.11	Preset Speed 12	0.00 - Maximum Frequency F00.16	Hz	50.00	●
F08.12	Preset Speed 13	0.00 - Maximum Frequency F00.16	Hz	50.00	●
F08.13	Preset Speed 14	0.00 - Maximum Frequency F00.16	Hz	50.00	●
F08.14	Preset Speed 15	0.00 - Maximum Frequency F00.16	Hz	50.00	●
F08.15	Simple PLC Running Mode	0: Stop after Single Running 1: Stop after Limited Times of Cycles 2: Run at Last Preset Speed after Limited Times of Cycles 3: Continuous Cycle		0	●
F08.16	Limited Times of Cycles	1 - 10000		1	●
F08.17	Simple PLC Memory	Ones Place: Stop Memory 0: Disabled (Start from the Preset Speed 1) 1: Enabled (Start at Power Failure) Tens Place: Power Failure Memory 0: Disabled (Start from the Preset Speed 1) 1: Enabled (Start at Power Failure)		0	●
F08.18	Simple PLC Time Unit	0: s 1: min		0	●
F08.19	Setting of Preset Speed 1	Ones Place: Running Direction 0: Forward 1: Reverse Tens Place: Acceleration/Deceleration Time 0: Acceleration/Deceleration Time 1 1: Acceleration/Deceleration Time 2 2: Acceleration/Deceleration Time 3		0	●

Function Code	Name of Function Code	Parameter Description	Unit	Default	Property
		3: Acceleration/Deceleration Time 4			
F08.20	Running Time of Preset Speed 1	0.0 - 6000.0	s /min	5.0	●
F08.21	Setting of Preset Speed 2	Ones Place: Running Direction 0: Forward 1: Reverse Tens Place: Acceleration/Deceleration Time 0: Acceleration/Deceleration Time 1 1: Acceleration/Deceleration Time 2 2: Acceleration/Deceleration Time 3 3: Acceleration/Deceleration Time 4		0	●
F08.22	Running Time of Preset Speed 2	0.0 - 6000.0	s /min	5.0	●
F08.23	Running Time of Preset Speed 3	Ones Place: Running Direction 0: Forward 1: Reverse Tens Place: Acceleration/Deceleration Time 0: Acceleration/Deceleration Time 1 1: Acceleration/Deceleration Time 2 2: Acceleration/Deceleration Time 3 3: Acceleration/Deceleration Time 4		0	●
F08.24	Running Time of Preset Speed 3	0.0 - 6000.0	s /min	5.0	●
F08.25	Setting of Preset Speed 4	Ones Place: Running Direction 0: Forward 1: Reverse Tens Place: Acceleration/Deceleration Time 0: Acceleration/Deceleration Time 1 1: Acceleration/Deceleration Time 2 2: Acceleration/Deceleration Time		0	●

Function Code	Name of Function Code	Parameter Description	Unit	Default	Property
		3 3: Acceleration/Deceleration Time 4			
F08.26	Running Time of Preset Speed 4	0.0 - 6000.0	s /min	5.0	●
F08.27	Setting of Preset Speed 5	Ones Place: Running Direction 0: Forward 1: Reverse Tens Place: Acceleration/Deceleration Time 0: Acceleration/Deceleration Time 1 1: Acceleration/Deceleration Time 2 2: Acceleration/Deceleration Time 3 3: Acceleration/Deceleration Time 4		0	●
F08.28	Running Time of Preset Speed 5	0.0 - 6000.0	s /min	5.0	●
F08.29	Setting of Preset Speed 6	Ones Place: Running Direction 0: Forward 1: Reverse Tens Place: Acceleration/Deceleration Time 0: Acceleration/Deceleration Time 1 1: Acceleration/Deceleration Time 2 2: Acceleration/Deceleration Time 3 3: Acceleration/Deceleration Time 4		0	●
F08.30	Running Time of Preset Speed 6	0.0 - 6000.0	s /min	5.0	●
F08.31	Setting of Preset Speed 7	Ones Place: Running Direction 0: Forward 1: Reverse		0	●

Function Code	Name of Function Code	Parameter Description	Unit	Default	Property
		Tens Place: Acceleration/Deceleration Time 0: Acceleration/Deceleration Time 1 1: Acceleration/Deceleration Time 2 2: Acceleration/Deceleration Time 3 3: Acceleration/Deceleration Time 4			
F08.32	Running Time of Preset Speed 7	0.0 - 6000.0	s /min	5.0	●
F08.33	Setting of Preset Speed 8	Ones Place: Running Direction 0: Forward 1: Reverse Tens Place: Acceleration/Deceleration Time 0: Acceleration/Deceleration Time 1 1: Acceleration/Deceleration Time 2 2: Acceleration/Deceleration Time 3 3: Acceleration/Deceleration Time 4		0	●
F08.34	Running Time of Preset Speed 8	0.0 - 6000.0	s /min	5.0	●
F08.35	Setting of Preset Speed 9	Ones Place: Running Direction 0: Forward 1: Reverse Tens Place: Acceleration/Deceleration Time 0: Acceleration/Deceleration Time 1 1: Acceleration/Deceleration Time 2 2: Acceleration/Deceleration Time 3 3: Acceleration/Deceleration Time 4		0	●
F08.36	Running Time of Preset Speed 9	0.0 - 6000.0	s /min	5.0	●
F08.37	Setting of Preset Speed 10	Ones Place: Running Direction 0: Forward		0	●

Function Code	Name of Function Code	Parameter Description	Unit	Default	Property
		1: Reverse Tens Place: Acceleration/Deceleration Time 0: Acceleration/Deceleration Time 1 1: Acceleration/Deceleration Time 2 2: Acceleration/Deceleration Time 3 3: Acceleration/Deceleration Time 4			
F08.38	Running Time of Preset Speed 10	0.0 - 6000.0	s /min	5.0	●
F08.39	Setting of Preset Speed 11	Ones Place: Running Direction 0: Forward 1: Reverse Tens Place: Acceleration/Deceleration Time 0: Acceleration/Deceleration Time 1 1: Acceleration/Deceleration Time 2 2: Acceleration/Deceleration Time 3 3: Acceleration/Deceleration Time 4		0	●
F08.40	Running Time of Preset Speed 11	0.0 - 6000.0	s /min	5.0	●
F08.41	Setting of Preset Speed 12	Ones Place: Running Direction 0: Forward 1: Reverse Tens Place: Acceleration/Deceleration Time 0: Acceleration/Deceleration Time 1 1: Acceleration/Deceleration Time 2 2: Acceleration/Deceleration Time 3 3: Acceleration/Deceleration Time 4		0	●
F08.42	Running Time of Preset Speed 12	0.0 - 6000.0	s /min	5.0	●
F08.43	Setting of Preset	Ones Place: Running Direction		0	●

Function Code	Name of Function Code	Parameter Description	Unit	Default	Property
	Speed 13	0: Forward 1: Reverse Tens Place: Acceleration/Deceleration Time 0: Acceleration/Deceleration Time 1 1: Acceleration/Deceleration Time 2 2: Acceleration/Deceleration Time 3 3: Acceleration/Deceleration Time 4			
F08.44	Running Time of Preset Speed 13	0.0 - 6000.0	s /min	5.0	●
F08.45	Setting of Preset Speed 14	Ones Place: Running Direction 0: Forward 1: Reverse Tens Place: Acceleration/Deceleration Time 0: Acceleration/Deceleration Time 1 1: Acceleration/Deceleration Time 2 2: Acceleration/Deceleration Time 3 3: Acceleration/Deceleration Time 4		0	●
F08.46	Running Time of Preset Speed 14	0.0 - 6000.0	s /min	5.0	●
F08.47	Setting of Preset Speed 15	Ones Place: Running Direction 0: Forward 1: Reverse Tens Place: Acceleration/Deceleration Time 0: Acceleration/Deceleration Time 1 1: Acceleration/Deceleration Time 2 2: Acceleration/Deceleration Time 3 3: Acceleration/Deceleration Time 4		0	●
F08.48	Running Time of Preset Speed 15	0.0 - 6000.0	s /min	5.0	●

Function Code	Name of Function Code	Parameter Description	Unit	Default	Property
F09	PID Functional Group				
F09.00	PID Setting Source	0: Numeric PID Setting 1: AI1 2: AI2 3: AI3 4: AI4 (Expansion Card) 5: High-Frequency Pulse (X7) 6: Communication Setting		0	○
F09.01	Numeric PID Setting	0.0 – PID Setting Feedback Range F09.03		0.0	●
F09.02	PID Feedback Source	1: AI1 2: AI2 3: AI3 4: AI4 (Expansion Card) 5: High-Frequency Pulse (X7) 6: Communication Setting		1	○
F09.03	PID Setting Feedback Range	0.1 - 6000.0		100.0	●
F09.04	Positive/Negative Reaction	0: Positive Action 1: Negative Action		0	○
F09.05	Proportional Gain 1	0.00 - 100.00		0.40	●
F09.06	Integral Time 1	0.000 - 30.000, 0.000: No Integral	s	10.000	●
F09.07	Differential Time 1	0.000 - 30.000	ms	0.000	●
F09.08	Proportional Gain 2	0.00 - 100.00		0.40	●
F09.09	Integral Time 2	0.000 - 30.000, 0.000: No Integral	s	10.000	●
F09.10	Differential Time 2	0.000 - 30.000	ms	0.000	●
F09.11	PID Parameter Switching	0: Disabled 1: Switching through Numeric Input Terminal 2: Automatic Switching by Offset		0	●
F09.12	PID Parameter Switching Offset 1	0.00 - F09.13	%	20.00	●
F09.13	PID Parameter Switching Offset 2	F09.12 - 100.00	%	80.00	●
F09.14	PID Initial Value	0.00 - 100.00	%	0.00	●
F09.15	PID Initial Value Retention time	0.00 - 650.00	s	0.00	●
F09.16	Upper Limit of PID Output	F9.17 - +100.0	%	100.0	●
F09.17	Lower Limit of PID Output	-100.0 - F9.16	%	0.0	●
F09.18	PID Offset Limit	0.00 - 100.00, Disabled at 0.00	%	0.00	●
F09.19	PID Differential	0.00 - 100.00	%	5.00	●

Function Code	Name of Function Code	Parameter Description	Unit	Default	Property
	Limit				
F09.20	PID Integral Separation Threshold	0.00 - 100.00, (100.00%=Integral Separation Disabled)	%	100.00	●
F09.21	PID Setting Variation Time	0.000 - 30.000	s	0.000	●
F09.22	PID Feedback Filter Time	0.000 - 30.000	s	0.000	●
F09.23	PID Output Filter Time	0.000 - 30.000	s	0.000	●
F09.24	Upper Limit Detection Value of PID Feedback Disconnection	0.00 - 100.00 100.00=Feedback Disconnection Disabled	%	100.00	●
F09.25	Lower Limit Detection Value of PID Feedback Disconnection	0.00 - 100.00 0.00=Feedback Disconnection Disabled	%	0.00	●
F09.26	PID Feedback Disconnection Detection Time	0.000 - 30.000	s	0.000	●
F09.27	PID Sleep Control	0: Disable 1: Zero Speed Enable 2: Lower Limit Frequency Enable 3: No Output Enable		0	●
F09.28	Sleep Action Point	0.00 - 100.00 (100.00 corresponds to PID Setting Feedback Range)	%	100.00	●
F09.29	Sleep Delay Time	0.0 - 6500.0	s	0.0	●
F09.30	Awakening Action Point	0.00 - 100.00 (100.00 corresponds to PID Setting Feedback Range)	%	0.00	●
F09.31	Awakening Delay Time	0.0 - 6500.0	S	0.0	●
F09.32	Preset PID Setting 1	0.0 – PID Setting Feedback Range F09.03		0.0	●
F09.33	Preset PID Setting 2	0.0 – PID Setting Feedback Range F09.03		0.0	●
F09.34	Preset PID Setting 3	F09.03 0.0 – PID Setting Feedback Range F09.03		0.0	●
F10	Communication Function Group				
F10.00	Inverter Address	1 - 247, 0 as broadcasting address		1	○
F10.01	Communication Bit Rate	0: 4800 1: 9600 2: 19200 3: 38400		1	○

Function Code	Name of Function Code	Parameter Description	Unit	Default	Property
		4: 57600 5: 115200			
F10.02	Modbus Data Format	0: 1-8-N-1 (1 start bit + 8 data bits +1 stop bit) 1: 1-8-E-1 (1 start bit + 8 data bits + 1 even parity + 1 stop bit) 2: 1-8-O-1 (1 start bit + 8 data bits + 1 odd parity + 1 stop bit) 3: 1-8-N-2 (1 start bit + 8 data bits +2 stop bits) 4: 1-8-E-2 (1 start bit + 8 data bits + 1 even parity +2 stop bits) 5: 1-8-O-2 (1 start bit + 8 data bits + 1 odd parity +2 stop bits)		0	○
F10.03	Communication Overtime	0.0s - 60.0s, 0.0: Disabled (also works for master - slave system)	s	0.0	●
F10.04	Modbus Response Delay	1 - 20	ms	2	●
F10.05	Master-Slave Communication Function	0: Disabled 1: Enabled		0	○
F10.06	Master-Slave Options	0: Slave 1: Master (Sent by Broadcast)		0	○
F10.07	Data Sent by Master	0: Output Frequency 1: Set Frequency 2: Output Torque 3: Set Torque 4: PID Setting 5: Output Current		1	○
F10.08	Receiving Proportionality Factor of Slave	0.00 - 10.00 (Times)		1.00	●
F10.09	Sending Interval of Master	0.000 - 30.000	s	0.200	●
F10.10	Communication Protocol	0: Modbus-RTU Protocol 1: Profibus-DP Protocol 2: CANopen Protocol 3: DeviceNet Protocol		0	○
F10.11	Communication Address of Profibus-DP Expansion Card	1 - 125		1	○
F10.12	Communication Address of CANopen	1 - 127		1	○

Function Code	Name of Function Code	Parameter Description	Unit	Default	Property
	Expansion Card				
F10.13	Communication Address of DeviceNet Expansion Card	0 - 63		1	○
F10.14	Response Delay Time of Process Data of Communication Card	0.0 - 200.0	ms	0.0	○
F10.15	Bit Rate of Communication between Expansion Card and Bus	Ones Place: CANopen 0: 125K 1: 250K 2: 500K 3: 1M Tens Place: DeviceNet 0: 125K 1: 250K 2: 500K		23	○
F10.16	PROFIBUS Communication Format	0: PPO1 1: PPO2 2: PPO3 3: PPO4 4: PPO5			×
F10.17	Received Data Type PZD2	When the displayed data is 65535, it means that present PZD is not used. When the displayed data is other data, for example 4609, it means that the function parameter is F18.01 (18D=12H, 01D=01H, 1201H=4609D)		65535	○
F10.18	Received Data Type PZD3			65535	○
F10.19	Received Data Type PZD4			65535	○
F10.20	Received Data Type PZD5			65535	○
F10.21	Received Data Type PZD6			65535	○
F10.22	Received Data Type PZD7			65535	○
F10.23	Received Data Type PZD8			65535	○
F10.24	Received Data Type PZD9			65535	○
F10.25	Received Data Type PZD10			65535	○
F10.26	Received Data Type PZD11			65535	○

Function Code	Name of Function Code	Parameter Description	Unit	Default	Property
F10.27	Received Data Type PZD12			65535	○
F10.28	Received Data Type PZD13			65535	○
F10.29	Received Data Type PZD14			65535	○
F10.30	Received Data Type PZD15			65535	○
F10.31	Received Data Type PZD16			65535	○
F10.32	Sent Data Type PZD2			65535	○
F10.33	Sent Data Type PZD3			65535	○
F10.34	Sent Data Type PZD4			65535	○
F10.35	Sent Data Type PZD5			65535	○
F10.36	Sent Data Type PZD6			65535	○
F10.37	Sent Data Type PZD7			65535	○
F10.38	Sent Data Type PZD8			65535	○
F10.39	Sent Data Type PZD9			65535	○
F10.40	Sent Data Type PZD10			65535	○
F10.41	Sent Data Type PZD11			65535	○
F10.42	Sent Data Type PZD12			65535	○
F10.43	Sent Data Type PZD13			65535	○
F10.44	Sent Data Type PZD14			65535	○
F10.45	Sent Data Type PZD15			65535	○
F10.46	Sent Data Type PZD16			65535	○
F10.47	Communication Card Status	Ones Place: Profibus-DP 0: Initialization Status 1: Wait for Parameterization Status 2: Wait for Configuration Status 3: Data Exchange Status 4: Modbus Communication Fault Status 5: Factory Test Status Tens Place: CANopen 0: Initialization Status 1: Pre-Operation Status		000	×

Function Code	Name of Function Code	Parameter Description	Unit	Default	Property
		2: Operation Status 3: Stop Status 4: CANopen Communication Fault Status 5: Modbus Communication Fault Status 6: Factory Test Status Hundreds Place: DeviceNet 0: Initialization Status 1: MACID Detection Status 2: Online Non-Connection Status 3: Connection Status 4: IO Communication Overtime Status 5: DeviceNet Bus Communication Fault Status 6: Modbus Communication Fault Status 7: Factory Test Status			
F10.48	Communication Card Software Version				×
F10.49	number of process data received	1~16		2	●
F10.50	number of process data transmission	1~16		2	●
F10.51	Process data address setting mode selection	0: keypad 1: Master		0	●
F10.52	Communication card manual reset selection	0: disable 1: enable		0	●
F10.53 – F10.55	Not Used	-	-	-	-
F10.56	RS485Write EEPROM	0~10: default for debugging 11: No trigger write before debugging		0	○
F11	User-Defined Parameter Group				
F11.00	User-Defined Parameter 1	The content displays Uxx.xx, which means that Fxx.xx function code is selected. If keypad displays U00.00 at the time of entering function code F11.00, it means that the first user-defined parameter is F00.00.		U00.00	●
F11.01	User-Defined Parameter 2			U00.01	●
F11.02	User-Defined Parameter 3			U00.02	●

Function Code	Name of Function Code	Parameter Description	Unit	Default	Property
F11.03	User-Defined Parameter 4			U00.03	●
F11.04	User-Defined Parameter 5			U00.04	●
F11.05	User-Defined Parameter 6			U00.07	●
F11.06	User-Defined Parameter 7			U00.14	●
F11.07	User-Defined Parameter 8			U00.15	●
F11.08	User-Defined Parameter 9			U00.16	●
F11.09	User-Defined Parameter 10			U00.18	●
F11.10	User-Defined Parameter 11			U00.19	●
F11.11	User-Defined Parameter 12			U00.29	●
F11.12	User-Defined Parameter 13			U02.00	●
F11.13	User-Defined Parameter 14			U02.01	●
F11.14	User-Defined Parameter 15			U02.02	●
F11.15	User-Defined Parameter 16			U03.00	●
F11.16	User-Defined Parameter 17			U03.02	●
F11.17	User-Defined Parameter 18			U03.21	●
F11.18	User-Defined Parameter 19			U04.00	●
F11.19	User-Defined Parameter 20			U04.20	●
F11.20	User-Defined Parameter 21			U05.00	●
F11.21	User-Defined Parameter 22			U05.03	●
F11.22	User-Defined Parameter 23			U05.04	●
F11.23	User-Defined Parameter 24			U08.00	●
F11.24	User-Defined			U19.00	●

Function Code	Name of Function Code	Parameter Description	Unit	Default	Property
	Parameter 25				
F11.25	User-Defined Parameter 26			U19.01	●
F11.26	User-Defined Parameter 27			U19.02	●
F11.27	User-Defined Parameter 28			U19.03	●
F11.28	User-Defined Parameter 29			U19.04	●
F11.29	User-Defined Parameter 30			U19.05	●
F11.30	User-Defined Parameter 31			U19.06	●
F11.31	User-Defined Parameter 32			U19.12	●
F12	Keypad and Display Function Group				
F12.00	M.K	0: No Function 1: Forward JOG 2: Reverse JOG 3: Forward/Reverse Switch 4: Rapid Stop 5: Coast to Stop 6: Cursor Left Shift		1	○
F12.01	STOP	0: Valid Only at Keypad Control 1: Valid at All Command Channels		1	○
F12.02	Parameter Locking	0: Unlocked 1: Reference Input, Unlocked 2: All Locked Except this Function Code		0	●
F12.03	Parameter Copy	0: No Operation 1: Upload Parameter to Keypad 2: Download Parameter to Inverter		0	○
F12.04	LED Display Parameter 1	00000000 - 11111111 (o for non-displaying, 1 for displaying) bit0: Output Frequency bit1: Set Frequency bit2: Output Current bit3: Output Voltage bit4: DC Bus Voltage bit5: Output Power bit6: Output Torque bit7: Torque Setting		000 11111	●
F12.05	LED Display	00000000 - 11111111 (o for		000	●

Function Code	Name of Function Code	Parameter Description	Unit	Default	Property
	Parameter 2	non-displaying, 1 for displaying) bit0: PG Feedback Frequency bit1: Estimated Feedback Frequency bit2: Load Speed bit3: Numeric Input Terminal Status 1 bit4: Numeric Input Terminal Status 2 bit5: Numeric Input Terminal Status 3 bit6: Numeric Output Terminal Status 2 bit7: AI1		00000	
F12.06	LED Display Parameter 3	00000000 – 11111111 (o for non-displaying, 1 for displaying) bit0: AI2 Bit1: AI3 Bit2: AI4 Bit3: PID Input bit4: PID Feedback bit5: Count Value bit6: Actual Length bit7: High-Frequency Pulse Input Frequency: kHz		000 00000	•
F12.07	LED Display Parameter 4	bit0: High-Frequency Pulse Input Frequency, Hz bit1: kilowatt-hour meter, MWh bit2: kilowatt-hour meter, kWh bit3: Remaining Time of Timed Run bit4: Simple PLC Running Times bit5: Simple PLC Running Stage bit6: PLC Running Time of Present Stage		000 00000	•
F12.08	LED Display Parameter 5	00000000 - 00001111 (o for non-displaying, 1 for displaying) bit0: UP/DOWN Offset bit1: VF Separation Output Voltage bit2: VF Separation Target Voltage bit3: Motor Temperature bit4 - bit7: Not Used		*** *0000	•
F12.09	Load Speed Display Factor	0.01 - 600.00		30.00	•

Function Code	Name of Function Code	Parameter Description	Unit	Default	Property
F12.10	UP/DOWN Acceleration/Deceleration Rate	0.00: Automatic Rate 0.01 - 500.00	Hz/s	5.00	○
F12.11	UP/DOWN Offset Clear	0: Not to Clear 1: Clear at Non-Running Status 2: Clear at Disabled UP/DOWN		1	○
F12.12	Power Failure Save of UP/DOWN Offset	0: Disabled 1: Enabled (only at modified offset)		0	○
F12.13	Kilowatt-Hour Meter Clear	0: Not to Clear 1: Clear		0	●
F12.14	Reset	0: No Operation 1: Reset (exclusive of motor parameter, inverter parameter, manufacturer parameter, running and power-on time record)		0	○
F12.15	Accumulated Power-On Time h	0 - 65535	h	XXX	×
F12.16	Accumulated Power-On Time min	0 - 59	min	XXX	×
F12.17	Accumulated Running Time h	0 - 65535	h	XXX	×
F12.18	Accumulated Running Time min	0 - 59	min	XXX	×
F12.19	Modbus Data Format	0.40 - 650.00	kW	Up To Specific Model	×
F12.20	Inverter Rated Power	60 - 690	V	Up To Specific Model	×
F12.21	Inverter Rated Voltage	0.1 - 1500.0	A	Up To Specific Model	×
F12.22	Performance Software Serial Number1	XXX.XX		XXX.XX	×
F12.23	Performance Software Serial Number2	XX.XXX		XX.XXX	×
F12.24	Function Software Serial Number 1	XXX.XX		XXX.XX	×
F12.25	Function Software Serial Number 2	XX.XXX		XX.XXX	×
F12.26	Keypad Software Serial Number 1	XXX.XX		XXX.XX	×

Function Code	Name of Function Code	Parameter Description	Unit	Default	Property
F12.27	Keypad Software Serial Number 2	XX.XXX		XX.XXX	×
F12.28	Keypad Product Serial Number 1	XX.XXX		XX.XXX	×
F12.29	Keypad Product Serial Number 2	XXXX.X		XXXX.X	×
F12.30	Keypad Product Serial Number 3	XXXXX		XXXXX	×
F12.31	LCD Language	0: Chinese 1: English 2: Not Used		0	●
F12.32	Monitor mode	0: Mode 0 1: Mode 1		1	●
F12.33	Mode 1 display parameter 1 (LED Stop status display parameter 5)	0.00~99.99		18.00	●
F12.34	Mode 1 display parameter 2 (LED Stop status display parameter 1)	0.00~99.99		18.01	●
F12.35	Mode 1 display parameter 3 (LED Stop status display parameter 2)	0.00~99.99		18.06	●
F12.36	Mode 1 display parameter 4 (LED Stop status display parameter 3)	0.00~99.99		18.08	●
F12.37	Mode 1 display parameter 5 (LED Stop status display parameter 4)	0.00~99.99		18.09	●
F12.38	LCD display parameter 1	0.00~99.99		18.00	●
F12.39	LCD display parameter 2	0.00~99.99		18.06	●
F12.40	LCD display parameter 3	0.00~99.99		18.09	●
F12.41	UP/DOWN cross zero option	0: forbidden 1: allowed		0	○
F13	Torque Control Parameter Group				
F13.00	Speed/Torque	0: Speed Control		0	○

Function Code	Name of Function Code	Parameter Description	Unit	Default	Property
	Control	1: Torque Control			
F13.01	Torque Setting	0: Numeric Torque Setting F13.02 1: AI1 2: AI2 3: AI3 4: AI4 (Expansion Card) 5: High-Frequency Pulse Input (X7) 6: Communication Setting (Full ranges of options 1 to 6, correspond to numeric torque setting F13.02)		0	○
F13.02	Numeric Torque Setting	-200.0 - 200.0 (100.0= Motor Rated Torque)	%	100.0	●
F13.03	Preset Torque 1	-200.0 - 200.0	%	0.0	●
F13.04	Preset Torque 2	-200.0 - 200.0	%	0.0	●
F13.05	Preset Torque 3	-200.0 - 200.0	%	0.0	●
F13.06	Torque Control Acceleration/Deceleration Time	0.00 - 120.00	s	0.05	●
F13.07	Not Used				
F13.08	Upper Limit Frequency of Torque Control	0: Set through F13.09 1: AI1 2: AI2 3: AI3 4: AI4 (Expansion Card) 5: High-Frequency Pulse Input (X7) 6: Communication Percentage Setting 7: Communication Direct Setting		0	○
F13.09	Upper Limit Frequency of Torque Control	0.00 - Maximum Frequency F00.16	Hz	50.00	●
F13.10	Upper Limit Frequency Offset	0.00 - Maximum Frequency F00.16	Hz	0.00	●
F13.11	Static Friction Torque Compensation	0.0 - 100.0	%	0.0	●
F13.12	Static Friction Compensation Frequency Range	0.00 - 50.00	Hz	1.00	●
F13.13	Not Used	-	-	-	-

Function Code	Name of Function Code	Parameter Description	Unit	Default	Property
F13.17					
F13.18	Reverse speed limit selection	0 - 100	%	100	●
F13.19	Torque Control Speed Priority Selection	0: Disabled 1: Enabled		0	●
F14	Motor 2 Parameter Group				
F14.00	Motor Type	0: Induction Motor 1: Inverter Induction Motor 2: Permanent Magnet Synchronous Motor		0	○
F14.01	Motor Rated Power	0.10 - 650.00	kW	Up To Specific Model	○
F14.02	Motor Rated Voltage	50 - 2000	V	Up To Specific Model	○
F14.03	Motor Rated Current	0.01 - 600.00 (Motor Rated Power ≤ 75kW) 0.1 - 6000.0 (Motor Rated Power >75kW)	A	Up To Specific Model	○
F14.04	Motor Rated Frequency	0.01 - 600.00	Hz	Up To Specific Model	○
F14.05	Motor Rated Speed	1 - 60000	rpm	Up To Specific Model	○
F14.06	Motor Winding Connection	0: Y 1: Δ		Up To Specific Model	○
F14.07	Motor Rated Power Factor	0.600 - 1.000		Up To Specific Model	○
F14.08	Motor Efficiency	30.0 - 100.0	%	Up To Specific Model	○
F14.09	Stator Resistor of Induction Motor	1 - 60000 (Motor Rated Power ≤ 75kW) 0.1 - 6000.0 (Motor Rated Power >75kW)	mΩ	Up To Specific Model	○
F14.10	Rotor Resistor of	1 - 60000 (Motor Rated Power ≤	mΩ	Up To	○

Function Code	Name of Function Code	Parameter Description	Unit	Default	Property
	Induction Motor	75kW) 0.1 - 6000.0 (Motor Rated Power >75kW)		Specific Model	
F14.11	Leakage Inductance of Induction Motor	0.01 - 600.00 (Motor Rated Power ≤ 75kW) 0.001 - 60.000 (Motor Rated Power >75kW)	mH	Up To Specific Model	○
F14.12	Mutual Inductance of Induction Motor	0.1 - 6000.0 (Motor Rated Power ≤ 75kW) 0.01 - 600.00 (Motor Rated Power >75kW)	mH	Up To Specific Model	○
F14.13	Idling Excitation Current of Induction Motor	0.1 - 600.00 (Motor Rated Power ≤ 75kW) 0.1 - 6000.0 (Motor Rated Power >75kW)	A	Up To Specific Model	○
F14.14	Induction Motor Field Weakening Factor 1	10.00 - 100.00	%	87.00	○
F14.15	Induction Motor Field Weakening Factor 2	10.00 - 100.00	%	80.00	○
F14.16	Induction Motor Field Weakening Factor 3	10.00 - 100.00	%	75.00	○
F14.17	Induction Motor Field Weakening Factor 4	10.00 - 100.00	%	72.00	○
F14.18	Induction Motor Field Weakening Factor 5	10.00 - 100.00	%	70.00	○
F14.19	Stator Resistor of Synchronous Motor	1 - 60000 (Motor Rated Power ≤ 75kW) 0.1 - 6000.0 (Motor Rated Power >75kW)	mΩ	Up To Specific Model	○
F14.20	d-Shaft Inductance of Synchronous Motor	0.01 - 600.00 (Motor Rated Power ≤ 75kW) 0.001 - 60.000 (Motor Rated Power >75kW)	mH	Up To Specific Model	○
F14.21	q-Shaft Inductance of Synchronous Motor	0.01 - 600.00 (Motor Rated Power ≤ 75kW) 0.001 - 60.000 (Motor Rated Power >75kW)	mH	Up To Specific Model	○
F14.22	Back Electromotive Force of	10.0 - 2000.0 (Back Electromotive Force of Rated Rotation Speed)	V	Up To Specific	○

Function Code	Name of Function Code	Parameter Description	Unit	Default	Property
	Synchronous Motor			Model	
F14.23	Initial Electric Angle of Synchronous Motor	0.0 - 359.9 (Synchronous motor enabled)			○
F14.24	Encoder Type	0: ABZ Incremental Encoder 1: UVW Incremental Encoder 2: UVW Wire-Saving Encoder 3: Not Used 4: Rotary Transformer		0	○
F14.25	Encoder Line Number	1 - 65535		1024	○
F14.26	Phase Angle of Zero Pulse of Encoder	0.0 - 359.9°		0.0	○
F14.27	AB Pulse Phase Sequence	0: Forward 1: Reverse		0	○
F14.28	Phase Sequence of UVW Encoder	0: Forward 1: Reverse		0	○
F14.29	UVW Initial Offset Phase Angle	0.0 - 359.9°		0.0	○
F14.30	Rotary Transformer Pole-Pairs	1 - 65535		1	○
F14.31	Not Used				
F14.32	Speed Feedback Disconnection Detection Time	0.0 - 10.0 (0.0: Speed Feedback Disconnection Detection Disabled)		0.0	○
F14.33	Filter Time of Speed Feedback	0.000 - 0.100	s	0.002	○
F14.34	Motor Parameter Autotuning	0: No Autotuning 1: Stationary Autotuning of Induction Motor 2: Rotational Autotuning of Induction Motor 3: Not Used 11: Stationary Autotuning of Synchronous Motor 12: Rotational Autotuning of Synchronous Motor 13: Autotuning of Encoder of Synchronous Motor		0	○
F14.35	Drive Control Mode of Motor 2	0: V/F control (VVF) 1: Sensorless Vector Control (SVC) 2: Feedback Vector Control (FVC)		0	○
F14.36	Speed Proportional	0.00 - 100.00		12.00	●

Function Code	Name of Function Code	Parameter Description	Unit	Default	Property
	Gain ASR_P1				
F14.37	Speed Integral Time Constant ASR_T1	0.000 - 30.000 0.000: No Integral	s	0.200	●
F14.38	Speed Proportional Gain ASR_P2	0.00 - 100.00		8.00	●
F14.39	Speed Integral Time Constant ASR_T2	0.000 - 30.000 0.000: No Integral	s	0.300	●
F14.40	Switching Frequency 1	0.00 - Switching Frequency 2	Hz	5.00	●
F14.41	Switching Frequency 2	Switching Frequency 1 - Maximum Frequency F00.16	Hz	10.00	●
F14.42	Velocity Loop Anti-Saturation Factor	0.000 - 1.000		0.500	●
F14.43	Time Constant of Output Filter of Velocity Loop	0.000 - 0.100	s	0.001	●
F14.44	Vector Control Slip Gain	50.00 - 200.00	%	100.00	●
F14.45	Speed control torque limit source selection	0: F06.10 and F06.11 1: AI1 2: AI2 3: AI3 4: AI4 (Expansion Card) 5: Communication (Percentage) 6: Maximum of AI2 and AI3 7: Minimum of AI2 and AI3		0	○
F14.46	Upper Limit of Electric Torque for Speed Control	0.0 - 250.0	%	165.0	●
F14.47	Upper Limit of Brake Torque for Speed Control	0.0 - 250.0	%	165.0	●
F14.48	Excitation Current Proportional Gain ACR-P1	0.00 - 100.00		0.50	●
F14.49	Excitation Current Integral Time Constant ACR-T1	0.00 - 600.00 0.000: No Integral	ms	10.00	●
F14.50	Torque Current Proportional Gain ACR-P2	0.00 - 10.00		0.50	●
F14.51	Torque Current	0.00 - 600.00	ms	10.00	●

Function Code	Name of Function Code	Parameter Description	Unit	Default	Property
	Integral Time Constant ACR-T2	0.000: No Integral			
F14.52	Not Used	-	-	-	-
F14.53	SVC Zero Frequency Processing Method	0: Brake 1: Normal 2: No output		2	○
F14.54	SVC Zero Frequency Band-Type Brake Current	50.0 - 400.0 (100.0=Idling Current)	%	100.0	○
F14.55	Not Used	-	-	-	-
F14.56	Voltage Feedforward Gain	0 - 100	%	0	●
F14.57	Field Weakening Control Options	0: Disabled 1: Direct Calculation 2: Automatic Adjustment		1	○
F14.58	Field Weakening Voltage	70.00 - 200.00	%	95.00	●
F14.59	Maximum Field Weakening Current of Synchronous Motor	0.0 - 150.0 (100.0= Motor Rated Current)	%	50.0	●
F14.60	Proportional Gain of Field Weakening Regulator	0.00 - 10.00		0.50	●
F14.61	Integral Time of Field Weakening Regulator	0.01 - 60.00	s	2.00	●
F14.62	MTPA Control Options of Synchronous Motor	0: Disabled 1: Enabled		0	○
F14.63	Gain of Autotuning at Initial Position	0 - 600	%	80	●
F14.64	Injection Current at Frequency of Low Frequency Range	0.00 - 100.00 (100.00= Motor Rated Frequency)	%	10.00	●
F14.65	Injection Current at Low Frequency Range	0.0 - 60.0 (100.0= Motor Rated Current)	%	20.0	●
F14.66	Low Frequency Range Regulator Gain of Injection Current	0.00 - 10.00		0.50	●
F14.67	Integral Time of Low	0.00 - 300.00	ms	10.00	●

Function Code	Name of Function Code	Parameter Description	Unit	Default	Property
	Frequency Range Regulator of Injection Current				
F14.68	Injection Current at Frequency of High Frequency Range	0.00 - 100.00 (100.00= Motor Rated Frequency)	%	20.00	●
F14.69	Injection Current at High Frequency Range	0.0 - 30.0 (100.0= Motor Rated Current)	%	8.0	●
F14.70	High Frequency Range Regulator Gain of Injection Current	0.00 - 10.00		0.50	●
F14.71	Integral Time of High Frequency Range Regulator of Injection Current	0.00 - 300.00	ms	10.00	●
F14.72 - F14.76	Not Used	-	-	-	-
F14.77	Motor 2 Acceleration/Deceleration Time	0: Same as Motor 1 1: Acceleration/Deceleration Time 1 2: Acceleration/Deceleration Time 2 3: Acceleration/Deceleration Time 3 4: Acceleration/Deceleration Time 4		0	○
F14.78	Motor 2 Maximum Frequency	1.00~600.00	Hz	50	○
F14.79	Motor 2 Upper Limit Frequency	Lower Limit Frequency F00.19 ~ Maximum Frequency F14.78	Hz	50	●
F14.80	Motor 2 V/F Curve Setting	0: Straight Line V/F 1: Multi-Dot Polyline V/F 2: VF to the 1.3 rd 3: VF to the 1.7 th 4: Square V/F 5: VF Complete Split Mode		0	○

Function Code	Name of Function Code	Parameter Description	Unit	Default	Property
		(Ud=0, Uq=K*t=Split voltage source voltage) 6: VF Half-Split Mode (Ud=0, Uq=K*t=F/Fe*2*Split voltage source voltage)			
F14.81	Motor 2 Multipoint VF Frequency Point F1	0.00~F14.83	Hz	0.50	●
F14.82	Motor 2 Multipoint VF Voltage Point F1	0.0~100.0 (100.0 = rated voltage)	%	1.0	●
F14.83	Motor 2 Multipoint VF Frequency Point F2	F14.81~F14.85	Hz	2.00	●
F14.84	Motor 2 Multipoint VF Voltage Point F2	0.0~100.0	%	4.0	●
F14.85	Motor 2 Multipoint VF Frequency Point F3	F14.83~motor rated frequency (reference frequency)	Hz	5.00	●
F14.86	Motor 2 Multipoint VF Voltage Point F3	0.0~100.0	%	10.0	●
F14.87	Stop Mode	0: Ramp-To-Stop 1: Coast-to-Stop		0	○
F15	Auxiliary Function Group				
F15.00	JOG Frequency	0.00 - Maximum Frequency F00.16	Hz	5.00	●
F15.01	JOG Acceleration Time	0.00 - 650.00 (F15.13=0) 0.0 - 6500.0 (F15.13=1) 0 - 65000 (F15.13=2)	s	5.00	●
F15.02	JOG Deceleration Time	0.00 - 650.00 (F15.13=0) 0.0 - 6500.0 (F15.13=1) 0 - 65000 (F15.13=2)	s	5.00	●
F15.03	Acceleration Time 2	0.00 - 650.00 (F15.13=0) 0.0 - 6500.0 (F15.13=1) 0 - 65000 (F15.13=2)	s	15.00	●
F15.04	Deceleration Time 2	0.00 - 650.00 (F15.13=0) 0.0 - 6500.0 (F15.13=1) 0 - 65000 (F15.13=2)	s	15.00	●
F15.05	Acceleration Time 3	0.00 - 650.00 (F15.13=0) 0.0 - 6500.0 (F15.13=1) 0 - 65000 (F15.13=2)	s	15.00	●
F15.06	Deceleration Time 3	0.00 - 650.00 (F15.13=0) 0.0 - 6500.0 (F15.13=1) 0 - 65000 (F15.13=2)	s	15.00	●
F15.07	Acceleration Time 4	0.00 - 650.00 (F15.13=0)	s	15.00	●

Function Code	Name of Function Code	Parameter Description	Unit	Default	Property
		0.0 - 6500.0 (F15.13=1) 0 - 65000 (F15.13=2)			
F15.08	Deceleration Time 4	0.00 - 650.00 (F15.13=0) 0.0 - 6500.0 (F15.13=1) 0 - 65000 (F15.13=2)	s	15.00	●
F15.09	Acceleration/Deceleration Time Reference Frequency	0: Maximum Frequency F00.16 1: 50.00 Hz		0	○
F15.10	Automatic Switching between Acceleration and Deceleration Time	0: Disabled 1: Enabled		0	○
F15.11	Switching Frequency between Acceleration Time 1 and Acceleration Time 2	0.00 Hz - Maximum Frequency F00.16	Hz	0.00	●
F15.12	Switching Frequency between Deceleration Time 1 and Deceleration Time 2	0.00 Hz - Maximum Frequency F00.16	Hz	0.00	●
F15.13	Acceleration/Deceleration Time Unit	0:0.01s 1:0.1s 2:1s		0	○
F15.14	Hopping Frequency Point 1	0.00 - 600.00	Hz	600.00	●
F15.15	Frequency Hopping Range 1	0.00 - 20.00 Disabled at 0.00	Hz	0.00	●
F15.16	Hopping Frequency Point 2	0.00 - 600.00	Hz	600.00	●
F15.17	Frequency Hopping Range 2	0.00 - 20.00 Disabled at 0.00	Hz	0.00	●
F15.18	Hopping Frequency Point 3	0.00 - 600.00	Hz	600.00	●
F15.19	Frequency Hopping Range 3	0.00 - 20.00 Disabled at 0.00	Hz	0.00	●
F15.20	FAR Detection Bandwidth	0.00 - 50.00	Hz	2.50	○
F15.21	Output Frequency Detection Range FDT1	0.00 - Maximum Frequency F00.16	Hz	30.00	○
F15.22	FDT1 Hysteresis	-(Fmax-F15.21)~F15.21	Hz	2.00	○
F15.23	Output Frequency Detection Range	0.00 - Maximum Frequency F00.16	Hz	20.00	○

Function Code	Name of Function Code	Parameter Description	Unit	Default	Property
	FDT2				
F15.24	FDT2 Hysteresis	-(Fmax-F15.23)~F15.23	Hz	2.00	○
F15.25	Analog Quantity Level Detection ADT	0: AI1 1: AI2 2: AI3 3: AI4 (Expansion Card)		0	○
F15.26	Analog Quantity Level Detection ADT1	0.00 - 100.00	%	20.00	●
F15.27	ADT1 Hysteresis	0.00 - F15.26 (Monotonic decreasing is active)	%	5.00	●
F15.28	Analog Quantity Level Detection ADT2	0.00 - 100.00	%	50.00	●
F15.29	ADT2 Hysteresis	0.00 - F15.28 (Monotonic decreasing is active)	%	5.00	●
F15.30	Energy Consumption Brake	0: Disabled 1: Enabled		0	○
F15.31	Operation Voltage of Dynamic Brake	110.0 - 140.0 (380V, 100.0=537V)	%	128.5	●
F15.32	Brake Duty Ratio	20 - 100 (100 means that duty ratio is 1)	%	100	●
F15.33	Control Mode of Set Frequency Lower Than Lower Limit Frequency	0: Run at Lower Limit Frequency 1: Stop 2: Run at Zero Speed		0	○
F15.34	Fan Control	0: Run at Energization 1: Run at Start 2: Run at Intelligent Temperature Control		1	○
F15.35	Overmodulation Intensity	1.00 - 1.10		1.05	●
F15.36	PWM Modulation Method Switching Options	0: Disabled (7 preset PWM modulation) 1: Enabled (5 preset PWM modulation)		0	○
F15.37	PWM Modulation Method Switching Frequency	0.00 - Maximum Frequency F00.16	Hz	15.00	●
F15.38	Deadband Compensation Mode	0: Disabled 1: Compensation Mode 1 2: Compensation Mode 2		1	○
F15.39	Terminal Jog Priority	0: Disabled		0	○

Function Code	Name of Function Code	Parameter Description	Unit	Default	Property
		1: Enabled			
F15.40	Deceleration Time at Rapid Stop	0.00 - 650.00 (F15.13=0) 0.0 - 6500.0 (F15.13=1) 0 - 65000 (F15.13=2)	s	1.00	●
F15.41 - F15.43	Not Used	-	-	-	-
F16	Customized Function Group				
F16.00	Not Used				
F16.01	Set Length	1-65535 (F16.13=0) 0. 1-6553.5 (F16.13=1) 0.01-655.35 (F16.13=2) 0.001-65.535 (F16.13=3)	m	1000	●
F16.02	Pulse Count Per Meter	0.1 - 6553.5		100.0	●
F16.03	Set Count Value	F16.04 - 65535		1000	●
F16.04	Designated Count Value	1 - F16.03		1000	●
F16.05	Set Timed Run Time	0.0 - 6500.0 Disabled at 0.0	min	0.0	●
F16.06	Agent Password	0 - 65535		0	○
F16.07	Set Accumulated Power-On Time Reach	0 - 65535, 0: Power-on Reach Time Protection Disabled	H	0	○
F16.08	Set Accumulated Run Time Reach	0 - 65535, 0: Run Time Reach Protection Disabled	H	0	○
F16.09	Factory Password	0 - 65535		XXXXX	●
F16.10	Analog Output percentage Corresponding to Zero of Setting Length/ Setting Count	0.00~100.00	%	0.00	○
F16.11	Analog Output Percentage Corresponding to Setting Value of Setting length/ Setting Count	0.00~100.00	%	100.00	○

Function Code	Name of Function Code	Parameter Description	Unit	Default	Property																
F16.12	Not Used	-	-	-	-																
F16.13	Setting Length resolution	0:1m 1:0.1m 2:0.01m 3:0.001m		0	○																
F17	Virtual I/O Function Group																				
F17.00	VX1 Virtual Input Function	Same as numeric input terminal function of F02 group		0	○																
F17.01	VX2 Virtual Input Function			0	○																
F17.02	VX3 Virtual Input Function			0	○																
F17.03	VX4 Virtual Input Function			0	○																
F17.04	VX5 Virtual Input Function			0	○																
F17.05	VX6 Virtual Input Function			0	○																
F17.06	VX7 Virtual Input Function			0	○																
F17.07	VX8 Virtual Input Function			0	○																
F17.08	Positive/Negative Logic of Virtual Input	<table border="1" style="font-size: small;"> <tr> <td>D7</td><td>D6</td><td>D5</td><td>D4</td><td>D3</td><td>D2</td><td>D1</td><td>D0</td> </tr> <tr> <td>VX8</td><td>VX7</td><td>VX6</td><td>VX5</td><td>VX4</td><td>VX3</td><td>VX2</td><td>VX1</td> </tr> </table> <p>0: Positive Logic, Enabled at On/Disabled at Off 1: Negative Logic, Disabled at On/Enabled at Off</p>	D7	D6	D5	D4	D3	D2	D1	D0	VX8	VX7	VX6	VX5	VX4	VX3	VX2	VX1		000 00000	○
D7	D6	D5	D4	D3	D2	D1	D0														
VX8	VX7	VX6	VX5	VX4	VX3	VX2	VX1														
F17.09	VX1 - VX8 Status Setting	<table border="1" style="font-size: small;"> <tr> <td>D7</td><td>D6</td><td>D5</td><td>D4</td><td>D3</td><td>D2</td><td>D1</td><td>D0</td> </tr> <tr> <td>VX8</td><td>VX7</td><td>VX6</td><td>VX5</td><td>VX4</td><td>VX3</td><td>VX2</td><td>VX1</td> </tr> </table> <p>0: VXn Is Same as VYn Output 1: Status to be Set by F17.10</p>	D7	D6	D5	D4	D3	D2	D1	D0	VX8	VX7	VX6	VX5	VX4	VX3	VX2	VX1		000 00000	○
D7	D6	D5	D4	D3	D2	D1	D0														
VX8	VX7	VX6	VX5	VX4	VX3	VX2	VX1														
F17.10	VX1 - VX8 Status Setting	<table border="1" style="font-size: small;"> <tr> <td>D7</td><td>D6</td><td>D5</td><td>D4</td><td>D3</td><td>D2</td><td>D1</td><td>D0</td> </tr> <tr> <td>VX8</td><td>VX7</td><td>VX6</td><td>VX5</td><td>VX4</td><td>VX3</td><td>VX2</td><td>VX1</td> </tr> </table> <p>0: Disabled 1: Enabled</p>	D7	D6	D5	D4	D3	D2	D1	D0	VX8	VX7	VX6	VX5	VX4	VX3	VX2	VX1		000 00000	●
D7	D6	D5	D4	D3	D2	D1	D0														
VX8	VX7	VX6	VX5	VX4	VX3	VX2	VX1														
F17.11	VX1 Effective Delay Time	0.000 - 30.000	s	0.000	●																
F17.12	VX1 Ineffective Delay Time	0.000 - 30.000	s	0.000	●																
F17.13	VX2 Effective Delay Time	0.000 - 30.000	s	0.000	●																
F17.14	VX2 Ineffective	0.000 - 30.000	s	0.000	●																

Function Code	Name of Function Code	Parameter Description	Unit	Default	Property																
	Delay Time																				
F17.15	VX3 Effective Delay Time	0.000 - 30.000	s	0.000	●																
F17.16	VX3 Ineffective Delay Time	0.000 - 30.000	s	0.000	●																
F17.17	VX4 Effective Delay Time	0.000 - 30.000	s	0.000	●																
F17.18	VX4 Ineffective Delay Time	0.000 - 30.000	s	0.000	●																
F17.19	VY1 Virtual Output Function	Same as numeric output terminal function of F03 group		0	○																
F17.20	VY2 Virtual Output Function			0	○																
F17.21	VY3 Virtual Output Function			0	○																
F17.22	VY4 Virtual Output Function			0	○																
F17.23	VY5 Virtual Output Function			0	○																
F17.24	VY6 Virtual Output Function			0	○																
F17.25	VY7 Virtual Output Function			0	○																
F17.26	VY8 Virtual Output Function			0	○																
F17.27	Positive/Negative Logic of Virtual Input	<table border="1"> <tr> <td>D7</td><td>D6</td><td>D5</td><td>D4</td><td>D3</td><td>D2</td><td>D1</td><td>D0</td> </tr> <tr> <td>VY8</td><td>VY7</td><td>VY6</td><td>VY5</td><td>VY4</td><td>VY3</td><td>VY2</td><td>VY1</td> </tr> </table> <p>0: Positive Logic, Enabled at On/Disabled at Off 1: Negative Logic, Disabled at On/Enabled at Off</p>	D7	D6	D5	D4	D3	D2	D1	D0	VY8	VY7	VY6	VY5	VY4	VY3	VY2	VY1		000 00000	○
D7	D6	D5	D4	D3	D2	D1	D0														
VY8	VY7	VY6	VY5	VY4	VY3	VY2	VY1														
F17.28	Virtual Output Terminal Control	<table border="1"> <tr> <td>D7</td><td>D6</td><td>D5</td><td>D4</td><td>D3</td><td>D2</td><td>D1</td><td>D0</td> </tr> <tr> <td>D7</td><td>D6</td><td>D5</td><td>D4</td><td>D3</td><td>D2</td><td>D1</td><td>D0</td> </tr> </table> <p>0: To be determined by status of X1 – X7 1: To be determined by output function status</p>	D7	D6	D5	D4	D3	D2	D1	D0	D7	D6	D5	D4	D3	D2	D1	D0		000 00000	○
D7	D6	D5	D4	D3	D2	D1	D0														
D7	D6	D5	D4	D3	D2	D1	D0														
F17.29	VY1 Effective Delay Time	0.000 - 30.000	s	0.000	●																
F17.30	VY1 Ineffective Delay Time	0.000 - 30.000	s	0.000	●																
F17.31	VY2 Effective Delay Time	0.000 - 30.000	s	0.000	●																

Function Code	Name of Function Code	Parameter Description	Unit	Default	Property								
F17.32	VY2 Ineffective Delay Time	0.000 - 30.000	s	0.000	●								
F17.33	VY3 Effective Delay Time	0.000 - 30.000	s	0.000	●								
F17.34	VY3 Ineffective Delay Time	0.000 - 30.000	s	0.000	●								
F17.35	VY4 Effective Delay Time	0.000 - 30.000	s	0.000	●								
F17.36	VY4 Ineffective Delay Time	0.000 - 30.000	s	0.000	●								
F17.37	Virtual Input Terminal Status	<table border="1"> <tr> <td>VX8</td><td>VX7</td><td>VX6</td><td>VX5</td><td>VX4</td><td>VX3</td><td>VX2</td><td>VX1</td> </tr> </table>	VX8	VX7	VX6	VX5	VX4	VX3	VX2	VX1		000	×
		VX8	VX7	VX6	VX5	VX4	VX3	VX2	VX1				
0: Disabled 1: Enabled		00000											
F17.38	Virtual Output Terminal Status	<table border="1"> <tr> <td>VY8</td><td>VY7</td><td>VY6</td><td>VY5</td><td>VY4</td><td>VY3</td><td>VY2</td><td>VY1</td> </tr> </table>	VY8	VY7	VY6	VY5	VY4	VY3	VY2	VY1		000	×
		VY8	VY7	VY6	VY5	VY4	VY3	VY2	VY1				
0: Disabled 1: Enabled		00000											
F18	Monitoring Parameter Group												
F18.00	Output Frequency	0.00 - Upper Limit Frequency	Hz	0.00	×								
F18.01	Set Frequency	0.00 - Maximum Frequency F00.16	Hz	0.00	×								
F18.02	PG Feedback Frequency	0.00 - Upper Limit Frequency	Hz	0.00	×								
F18.03	Estimated Feedback Frequency	0.00 - Upper Limit Frequency	Hz	0.00	×								
F18.04	Output Torque	-200.0 - 200.0	%	0.0	×								
F18.05	Torque Setting	-200.0 - 200.0	%	0.0	×								
F18.06	Output Current	0.00 - 650.00 (Motor Rated Power ≤ 75kW)	A	0.00	×								
		0.0 - 6500.0 (Motor Rated Power >75kW)											
F18.07	Output Current Percentage	0.0 - 300.0 (100.0= Inverter Rated Current)	%	0.0	×								
F18.08	Output Voltage	0.0 - 690.0	V	0.0	×								
F18.09	DC bus Voltage	0 - 1200	V	0	×								
F18.10	Simple PLC Running Times	0 - 10000		0	×								
F18.11	Simple PLC Running Stage	1 - 15		1	×								
F18.12	PLC Running Time of Present Stage	0.0 - 6000.0		0.0	×								
F18.13	Not Used												
F18.14	Load Speed	0 - 65535	rpm	0	×								
F18.15	UP/DOWN Offset Frequency	0.00 - 2*Maximum Frequency F00.16	Hz	0.00	×								

Function Code	Name of Function Code	Parameter Description					Unit	Default	Property
F18.16	PID Setting	0.0 – PID Maximum Range						0.0	×
F18.17	PID Feedback	0.0 – PID Maximum Range						0.0	×
F18.18	Kilowatt-Hour Meter, MWh	0 - 65535					MWh	0	×
F18.19	Kilowatt-Hour Meter, kWh	0.0 - 999.9					kWh	0.0	×
F18.20	Output Power	0.00 - 650.00					kW	0.00	×
F18.21	Output Power Factor	-1.000 - 1.000						0.000	×
F18.22	Numeric Input Terminal Status 1	X5	X4	X3	X2	X1		00000	×
		0/1	0/1	0/1	0/1	0/1			
F18.23	Numeric Input Terminal Status 2	AI3	AI2	AI1	X7	X6		00000	×
		0/1	0/1	0/1	0/1	0/1			
F18.24	Numeric Input Terminal Status 3	AI4	X11	X10	X9	X8		00000	×
		0/1	0/1	0/1	0/1	0/1			
F18.25	Output Terminal Status	Y3	R2	R1	Y2	Y1		00000	×
		0/1	0/1	0/1	0/1	0/1			
F18.26	AI1	0.0 - 100.0					%	0.0	×
F18.27	AI2	0.0 - 100.0					%	0.0	×
F18.28	AI3	0.0 - 100.0					%	0.0	×
F18.29	AI4	-100.0 - 100.0					%	0.0	×
F18.30	Communication Setting	-100.0 - 100.0					%	0.0	×
F18.31	High-Frequency Pulse Input Frequency: kHz	0.00 - 100.00					kHz	0.00	×
F18.32	High-Frequency Pulse Input Frequency: Hz	0 - 65535					Hz	0	×
F18.33	Count Value	0 - 65535						0	×
F18.34	Actual Length	0 - 65535					m	0	×
F18.35	Remaining Time of Timed Run	0.0 - 6500.0					min	0.0	×
F18.36	Position of Rotor of Synchronous Motor	0.0 - 359.9°						0.0	×
F18.37	Rotary Transformer Position	0 - 4095						0	×
F18.38	Motor Temperature	0 - 200					°C	0	×
F18.39	VF Separation Target Voltage	0 - 690					V	0	×
F18.40	VF Separation Output Voltage	0 - 690					V	0	×

Function Code	Name of Function Code	Parameter Description	Unit	Default	Property
F18.41 - F18.42	Not Used	-	-	-	-
F18.43	Zero Servo Position Offset	0 - 65535		0	×
F18.44 - F18.50	Not Used	-	-	-	-
F18.51	PID Output	-300.0 - 300.0	%		×
F18.52	Spindle Orientation Setting Position	0 - 65535		0	×
F18.53	Spindle Orientation Current Position	0 - 65535		0	×
F18.54	Feed Setting High Byte	0 - 65535		0	×
F18.55	Feed Setting Low Byte	0 - 9999		0	×
F18.56	Feed Current High Byte	0 - 65535		0	×
F18.57	Feed Current Low Byte	0 - 9999		0	×
F18.58	Feedback Pulse High Byte	0 - 65535		0	×
F18.59	Feedback Pulse Low Byte	0 - 65535		0	×
F18.60	Not Used	-	-	-	-
F19	Fault Record Group				
F19.00	Last fault type	<i>0</i> : No Fault <i>5C</i> : Output Short Circuit Protection <i>HOC</i> : Instantaneous Overcurrent <i>HOU</i> : Instantaneous Overvoltage <i>SOE</i> : Stable Overcurrent <i>SOU</i> : Stable Overvoltage <i>S1U</i> : Stable Undervoltage <i>ILP</i> : Input Phase Loss <i>OLP</i> : Output Phase Lose <i>OL</i> : Inverter Overload <i>OH</i> : Inverter Overheating Protection <i>E11</i> : Parameter Setting Conflict <i>E12</i> : Motor Overheating <i>E13</i> : Motor Overload <i>E14</i> : External Fault <i>E15</i> : Inverter EEPROM Fault		0	×

Function Code	Name of Function Code	Parameter Description	Unit	Default	Property
		<i>E15</i> : Communication Fault <i>E17</i> : Temperature Sensor Fault <i>E18</i> : Soft Start Relay Off <i>E19</i> : Current Detection Circuit <i>E20</i> : Stall Fault <i>E21</i> : PID Feedback Disconnection <i>E22</i> : Encoder Fault <i>E23</i> : Keypad EEPROM Fault <i>E24</i> : Parameter Autotuning Fault <i>E25</i> : Motor Overspeed Protection <i>E26</i> : Offload Protection <i>E27</i> : Accumulated Power-On Time Reach <i>E28</i> : Accumulated Run Time Reach <i>E29</i> : Internal Communication Fault <i>E30</i> - <i>E32</i> : Not Used <i>E33</i> : CANopen Communication Overtime <i>E34</i> : DeviceNET without Network Power Supply <i>E35</i> : DeviceNET BUS-OFF <i>E36</i> : DeviceNET MACID Detection Failure <i>E37</i> : DeviceNET IO Communication Overtime <i>E38</i> : DeviceNET IO Mapping Error <i>E39</i> : Profibus-DP Parameterization Data Error <i>E40</i> : Profibus-DP Configuration Data Error <i>E41</i> : Profibus-DP IO Disconnection			
F19.01	Output Frequency at Fault	0.00 - Upper Limit Frequency	Hz	0.00	×
F19.02	Output Current at Fault	0.00 - 650.00 (Motor Rated Power ≤ 75kW) 0.0 - 6500.0 (Motor Rated Power >75kW)	A	0.00	×
F19.03	Bus Voltage at Fault	0 - 1200	V	0	×
F19.04	Running Mode at Fault	0: Not Running 1: Forward Acceleration 2: Reverse Acceleration 3: Forward Deceleration 4: Reverse Deceleration 5: Forward Constant Speed		0	×

Function Code	Name of Function Code	Parameter Description	Unit	Default	Property
		6: Reverse Constant Speed			
F19.05	Working Time at Fault		h	0	×
F19.06	Last Fault Type	See F19.00 Parameter Description		0	×
F19.07	Output Frequency at Fault		Hz	0.00	×
F19.08	Output Current at Fault		A	0.00	×
F19.09	Bus Voltage at Fault		V	0	×
F19.10	Running Mode at Fault	See F19.00 Parameter Description		0	×
F19.11	Working Time at Fault		h	0	×
F19.12	Types of Last Two Faults	See F19.04 Parameter Description		0	×
F19.13	Output Frequency at Fault		Hz	0.00	×
F19.14	Output Current at Fault		A	0.00	×
F19.15	Bus Voltage at Fault		V	0	×
F19.16	Running Mode at Fault	See F19.04 Parameter Description		0	×
F19.17	Working Time at Fault		h	0	×
F30	Position Control Parameter Group				
F30.00	Position Control Mode	0: Disabled 1: Zero Servo (Frequency Reach Enabled) 2: Zero Servo (Frequency Reach and Terminal Enabled) 3: Spindle Orientation 4: Feed		0	○
F30.01	Zero Servo Start Frequency	0.00 - 5.00	Hz	0.25	●
F30.02	Position loop gain	0.000 - 40.000		1.000	●
F30.03	Not Used	-	-	-	-
F30.04	Not Used	-	-	-	-
F30.05	Position Error Limit	0 - 9999		0	●
F30.06	Position Control Upper Limit Frequency	0.00 - Fmax	Hz	50.00	●
F30.07	Not Used	-	-	-	-

Function Code	Name of Function Code	Parameter Description	Unit	Default	Property
F30.08	Position Control Deceleration Time	0.00 - 600.00	s	0.50	●
F30.09	Not Used	-	-	-	-
F30.10	Position Feedback Mode	0: Motor Encoder Position 1: Extra Z Pulse Position 2: Spindle Encoder Position		0	○
F30.11	Position Complete Range	0 - 65535		10	●
F30.12	Position Complete Time	0 - 10000	ms	200	●
F30.13	Position Acknowledging time	0 - 1000	ms	10	●
F30.14	Spindle Orientation Position 1	0 - 65535		0	●
F30.15	Spindle Orientation Position 2	0 - 65535		0	●
F30.16	Spindle Orientation Position 3	0 - 65535		0	●
F30.17	Spindle Orientation Position 4	0 - 65535		0	●
F30.18	Spindle Orientation Position 5	0 - 65535		0	●
F30.19	Spindle Orientation Position 6	0 - 65535		0	●
F30.20	Spindle Orientation Position 7	0 - 65535		0	●
F30.21	Spindle Orientation Position 8	0 - 65535		0	●
F30.22	Spindle Orientation Speed	0.00 - Upper Limit Frequency	Hz	10.00	●
F30.23	Spindle Orientation Direction	0: Current Direction 1: Shortest Distance		0	○
F30.24	Spindle clamp locking delay time	0 - 30000	ms	0	○
F30.25	Spindle Encoder Type	0: ABZ Incremental Encoder 1: UVW Incremental Encoder 2: UVW Wire-Saving Encoder 3: Not Used 4: Rotary Transformer		0	○
F30.26	Spindle Encoder Resolution	1 - 65535		1024	○
F30.27	Not Used	-	-	-	-
F30.28	Not Used	-	-	-	-

Function Code	Name of Function Code	Parameter Description	Unit	Default	Property
F30.29	I Transmission Ratio Dividend	1 - 10000		1000	○
F30.30	I Transmission Ratio Divisor	1 - 10000		1000	○
F30.31	II Transmission Ratio Dividend	1 - 10000		1000	○
F30.32	II Transmission Ratio Divisor	1 - 10000		1000	○
F30.33	III Transmission Ratio Dividend	1 - 10000		1000	○
F30.34	III Transmission Ratio Divisor	1 - 10000		1000	○
F30.35	IV Transmission Ratio Dividend	1 - 10000		1000	○
F30.36	IV Transmission Ratio Divisor	1 - 10000		1000	○
F30.37	Not Used	-	-	-	-
F30.38	Original Point Returning Direction	0: Forward 1: Reverse		1	○
F30.39	Original Point Returning Frequency 1	0.00 - Fmax	Hz	10.00	○
F30.40	Original Point Returning Frequency 2	0.00 - 60.00	Hz	1.00	○
F30.41	Feed Terminal Selection on Feed Control	0: Forward Reverse Running Terminal 1: Forward Reverse Feed Terminal		0	○
F30.42	Feed High bit 1	0 - 60000 4 times the frequency/time, The following is the same	pluse	0	●
F30.43	Feed Low bit 1	0 - 9999		0	●
F30.44	Feed High bit 2	0 - 60000		0	●
F30.45	Feed Low bit 2	0 - 9999		0	●
F30.46	Feed High bit 3	0 - 60000		0	●
F30.47	Feed Low bit 3	0 - 9999		0	●
F30.48	Feed High bit 4	0 - 60000		0	●
F30.49	Feed Low bit 4	0 - 9999		0	●
F30.50	Feed High bit 5	0 - 60000		0	●
F30.51	Feed Low bit 5	0 - 9999		0	●
F30.52	Feed High bit 6	0 - 60000		0	●
F30.53	Feed Low bit 6	0 - 9999		0	●
F30.54	Feed High bit 7	0 - 60000		0	●

Function Code	Name of Function Code	Parameter Description	Unit	Default	Property
F30.55	Feed Low bit 7	0 - 9999		0	●
F30.56	Feed High bit 8	0 - 60000		0	●
F30.57	Feed Low bit 8	0 - 9999		0	●
F30.58	Stepping Increase	0 - 65535		0	●
F30.59	Stepping Decrease	0 - 65535		0	●

7 Parameter Description

7.1 F00 Group: General Parameter

Function Code	Name of Function Code	Parameter Description	Unit	Default	Property
F00.01	Drive Control Mode of Motor 1	0: V/F control (VVF) 1: Sensorless Vector Control (FVC) 2: Feedback Vector Control (FVC)		0	○

F00.01=0: V/F control (VVF)

Inverter is applicable for the occasions when multiple motors are driven by a single inverter or it is not required for quick response or high precision.

F00.01=1: Sensorless Vector Control (SVC)

Inverters under sensorless vector control are usually applied to high-performance control occasions and one inverter can only drive one motor. Loads include machine tool, centrifuge, wire-drawing machine and injection moulding machine.



F00.01=2: Feedback Vector Control (FVC)





In addition to installing an encoder for motor, EM600 inverter under FVC control must select a PG card matching with the encoder (see 11.4.2 PG Card Configuration Plan or Appendix II). It is suitable for high-accuracy speed control or torque control. An inverter can drive one motor only, for example high-speed papermaking machine, hoisting machine, elevator and other loads.

	<ol style="list-style-type: none"> Before running in vector control mode, inverter needs to autotune motor parameters to obtain correct motor parameters and enhance the control performance. While using vector control mode, inverter can only have one motor. Motor and inverter shall not be much different from each other in capacity, otherwise control performance will decrease or the system can not work normally.
--	---

Function Code	Name of Function Code	Parameter Description	Unit	Default	Property
F00.02	Command Source	0: Keypad Control (LOC/REM indicator on) 1: Terminal Control (LOC/REM indicator off) 2: Communication Control (LOC/REM indicator flickers)		0	○

F00.02=0: Keypad Control (LOC/REM indicator on)

Start and stop of inverter will be controlled with ,  and  of keypad.

Under no fault, press  to enter jog running mode or press  to enter running mode. When green LED above  button is always on, it means that inverter is running; when green LED above  button flickers, it means that inverter is in ramp-to-stop status. No matter whether reference input of control mode is speed or torque, inverter always runs at jog input speed control mode as long as jog is enabled.

No matter whether reference input of control mode is speed or torque, inverter always runs at jog input speed control mode as long as jog is enabled.

F00.02=1: Terminal Control (LOC/REM indicator off)

Start/stop control terminal defined through F02.00 - F02.06 controls start and stop of inverter; detailed configurations of terminal control are defined through F00.03.

F00.02=2: Communication Control (LOC/REM indicator flickers)

Host controller controls inverter to start and stop through RS485 communication interface. See 7000H in 12.3.4 Allocation of Register Address.

	Final command source is also determined by either “24: Switch Run Command to Keypad” or “25: Switch Run Command to Communication”: when input function “24: Switch Run Command to Keypad” is enabled, present command source is “Keypad Control”; when input function “25: Switch Run Command to Communication” is enabled, present command source is “Communication Control”; otherwise, final command source is determined through F00.02.
---	--

Function Code	Name of Function Code	Parameter Description	Unit	Default	Property
F00.03	Terminal Control Mode Options	0: Terminal RUN for running, Forward/Reverse (F/R) 1: Terminal RUN for forward, F/R reverse 2: Terminal RUN for forward, Xi stop, F/R reverse 3: Terminal RUN for running, Xi stop Forward/Reverse (F/R)		0	○

Terminal RUN: Xi=1, Run Terminal “RUN”

Terminal Forward/Reverse (F/R): Xi=2, Direction R/F

There are two terminal control modes, 2-wire sequence and 3-wire sequence.

2-Wire Sequence:

F00.03=0: Terminal RUN, Forward/Reverse (F/R)

ON/OFF of terminal RUN controls start and stop of inverter and OFF/ON of terminal F/R controls forward/reverse of inverter; if F00.21 is set as 1 and reverse is prohibited, terminal F/R is disabled. By selecting ramp-to-stop for stop mode, logic diagram is shown in Figure 7-1 (b).

F00.03=1: Terminal RUN forward, F/R reverse

ON/OFF of terminal RUN controls forward running and stop of inverter and ON/OFF of terminal F/R controls reverse and stop of inverter. If terminals RUN and F/R are on, inverter stops. If reverse is prohibited, terminal F/R is disabled. When selecting ramp-to-stop, control logic of inverter Forward/Reverse is shown in Figure 7-1 (d).

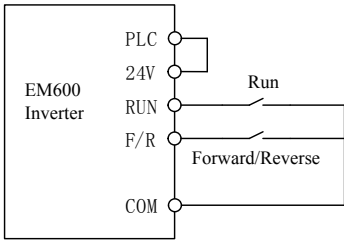

(a) F00.03=0 2-Wire Sequence Wiring Diagram

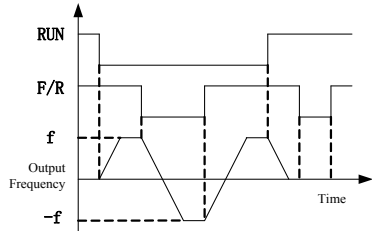

(b) F04.19=0, F00.03=0 Forward/Reverse Running Sequence

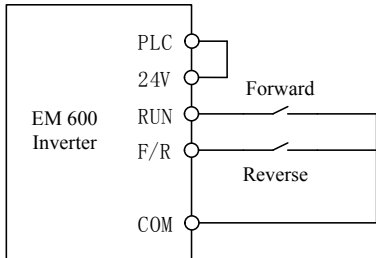

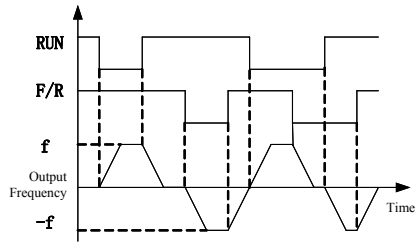

(c) F00.03=1 2-Wire Sequence Wiring Diagram



(d) F04.19=0, F00.03=1 Forward/Reverse Running Sequence

Figure 7-1 2-Wire Sequence

	<p>When selecting F00.03 start/stop option as 0 or 1, either pressing  or using an external terminal stop command can stop inverter, even if terminal RUN is on. At this time, terminal RUN shall be disabled and then enabled, it can once again enter running state.</p>
---	---

3-Wire Sequence:

F00.03=2: Terminal RUN forward, Xi stop, F/R reverse

RUN is a NO forward running button and F/R is a NO reverse running button; both of them are effective at pulse edge; Xi is a NC stop button and enabled at the level. Under running mode, pressing Xi can stop inverter. When stop mode is set as F04.19=0 Ramp-To-Stop, the logic diagram is shown in Figure 7-2 (b). Xi is a terminal among X1 - X7 and defined as 3-Wire Sequence Run/Stop Control.

F00.03=3: Terminal RUN, Xi stop, Forward/Reverse (F/R)

RUN is a NO running button, and will be on at pulse edge (F/R is on at level). F/R is a forward/reverse switching button (inverter forwards when F/R is disabled, and inverter reverses when F/R is enabled). Xi is a NC stop button, and on at the level. When the stop mode is set as F04.19=0 Ramp-To-Stop, the logic sequence is shown in Figure 7-2(d)..

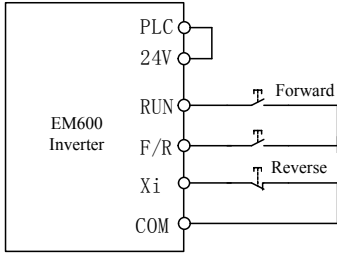

(a) F00.03=2 3-Wire Sequence Wiring Diagram

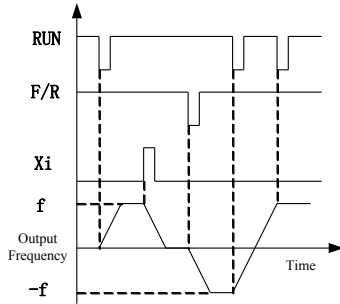

(b) F04.19=0, F00.03=2 Forward/Reverse Running Sequence

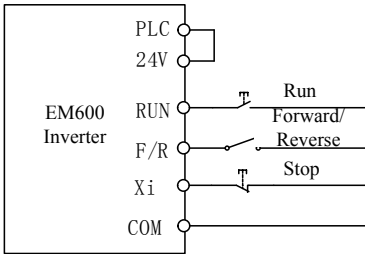

(c) F00.03=3 3-Wire Sequence Wiring Diagram

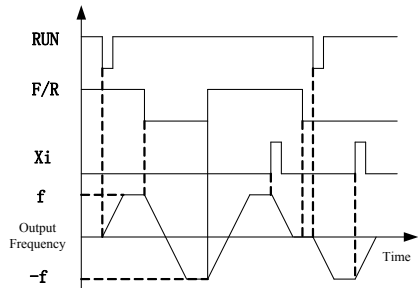

(d) F04.19=0, F00.03=3 Forward/Reverse Running Sequence

Figure 7-2 3-Wire Sequence

 The 3-wire sequence of EM600 Inverter conforms to traditional electrical control method. Please use buttons and knobs as shown in the diagram correctly so as to avoid malfunctions.

Function Code	Name of Function Code	Parameter Description	Unit	Default	Property
F00.04	Main Frequency Source A	0: Numeric frequency setting F00.07 1: AI1 2: AI2 3: AI3 4: AI4 (Expansion Card) 5: High-Frequency Pulse Input (X7) 6. Main Frequency Communication Percentage Setting 7. Main Frequency Communication Direct Setting		0	○

F00.04=0: Numeric frequency setting F00.07

Main frequency A is determined through numeric frequency setting F00.07.

F00.04=1: AI1**F00.04=2: AI2****F00.04=3: AI3****F00.04=4: AI4 (Expansion Card)**

Main frequency A is determined through AI (percentage) * F00.16 (or F14.78).

AI1 is 0 V to 10 V voltage input;

AI2/AI3 can be either 0 V to 10 V voltage input or 0 mA to 20 mA current input. Specific options can be made through terminal of terminal plate S4/S5.

AI4 is -10 V to 10 V voltage input and IO expansion card (EC-IO-A1) of SINEE is required.

The percentage corresponding to physical quantity input of AI terminal is set through F02.31 - F02.56. 100.00% corresponds to the value set through F00.16 (or F14.78) (Maximum Frequency).

F00.04=5: High-Frequency Pulse Input (X7)

Main frequency A is determined through HDI (percentage) * F00.16.

X7 can be also used as high-frequency pulse input (terminal function F02.06 shall be set as “40: Pulse Input”), with set frequency range of 0.00 to 100.00 kHz and set voltage range of 12 to 48 V. Percentage of terminal input pulse frequency shall be set through F02.26 - F02.29 and 100.00% is the percentage set through F00.16 (Maximum Frequency). The percentage corresponding to physical quantity input of AI terminal is set through F02.31 - F02.36. 100.00% corresponds to the value set through F00.16 (Maximum Frequency).

F00.04=6or7: Main Frequency Communication Setting

Main frequency A is determined through communication control, etc.

- If inverter is under master-slave communication control (F10.05=1) and present inverter is a slave (F10.06=0), main frequency A is set as “700 FH (Master-Slave Communication Setting) * F00.16 (or F14.78) (Maximum Frequency) * F10.08 (Receiving Proportionality Factor of Slave)”. Range of 700 FH is -100.00% to 100.00%. See Table 12-2 for details.
- For general communication (F10.05=0):
 - a) F00.04=6 Main Frequency Communication Percentage Setting. Main frequency source A is set as “7001H (communication setting of main channel frequency A) * F00.16 (or F14.78) (Maximum Frequency)”.
 - b) F00.04=7 Main Frequency Communication Direct Setting. Main frequency source A is set as “7015H (communication setting of main channel frequency A)”.

The range of 7001H is -100.00% to 100.00%. The range of 7015H is 0.00 to F00.16 (Maximum Frequency). See Table 12-2 for details.

The final main frequency source A is also set through DI terminal status:

Table 7-1 Setting of Main Frequency Source A

Terminal Function	Description	Priority
11 - 14: Preset Speed Terminals 1 - 4	It is preset speed when any terminal is enabled (F08.00 - F08.14).	1
51: Switch Main Frequency Source to Numeric	If enabled, numeric frequency is determined by F00.07, for which refer to description of	2

Terminal Function	Description	Priority
Frequency Setting	F00.04=0.	
52: Switch Main Frequency Source to AI1	If enabled, main frequency source A is determined by the percentage inputted through AI1, for which refer to description of F00.04=1.	3
53: Switch Main Frequency Source to AI2	If enabled, main frequency source A is determined by the percentage inputted through AI2, for which refer to description of F00.04=2.	4
54: Switch Main Frequency Source to AI3	If enabled, main frequency source A is determined by the percentage inputted through AI3, for which refer to description of F00.04=3.	5
55: Switch Main Frequency Source to High-Frequency Pulse Input	If enabled, main frequency source A is determined by the percentage inputted through high-frequency pulse input, for which refer to description of F00.04=5.	6
56: Switch Main Frequency Source to Communication Setting	If enabled, main frequency source A is determined through communication, for which refer to description of F00.04=6.	7
--	If neither of terminals above is enabled, main frequency source A is determined through F00.04.	8

Function Code	Name of Function Code	Parameter Description	Unit	Default	Property
F00.05	Auxiliary Frequency Source B	0: Numeric frequency setting F00.07 1: AI1 2: AI2 3: AI3 4: AI4 (Expansion Card) 5: High-Frequency Pulse Input (X7) 6. Auxiliary Frequency Communication Percentage Setting 7. Auxiliary Frequency Communication Direct Setting 8 - 9: Not Used 10: Process PID 11: Simple PLC		0	○

F00.05=0: Numeric frequency setting F00.07

Auxiliary frequency B is determined through numeric frequency setting F00.07.

F00.05=1: AI1

F00.05=2: AI2

F00.05=3: AI3

F00.05=4: AI4 (Expansion Card)

Auxiliary frequency B is determined through AI (percentage) * F00.16 (or F14.78).

F00.05=5: High-Frequency Pulse Input (X7)

Auxiliary frequency B is determined through HDI (percentage) * F00.16 (or F14.78).

Please refer to the description of F00.04 for detailed explanations of AI1-AI4 and X7. F00.04 has the same meanings as AI1-AI4 and X7. 100.00% is the percentage inputted through F00.16 (or F14.78) (Maximum Frequency).

F00.05=6 or 7: Main Frequency Communication Setting

Auxiliary frequency B is determined through communication control, etc.

- If inverter is under master-slave communication control (F10.05=1) and present inverter is a slave (F10.06=0), auxiliary frequency B is set as “700 FH (Master-Slave Communication Setting) * F00.16 (or F14.78) (Maximum Frequency) * F10.08 (Receiving Proportionality Factor of Slave)”. Range of 700 FH is -100.00% to 100.00%. See Table 12-2 for details.
- For general communication (F10.05=0):
 - a) F00.05=6 Auxiliary Frequency Communication Percentage Setting. Auxiliary frequency source A is set as “7002H (communication setting of auxiliary channel frequency B) * F00.16 (or F14.78) (Maximum Frequency)”.
 - b) F00.05=7 Auxiliary Frequency Communication Direct Setting. Auxiliary frequency source B is set as “7016H (communication setting of auxiliary channel frequency B)”.

The range of 7002H is -100.00% to 100.00%. The range of 7016H is 0.00 to F00.16 (Maximum Frequency). See Table 12-2 for details.

F00.05=10: Process PID

Auxiliary frequency B is determined by output of Process PID (refer to 7.10). Generally, it is used for on-site closed loop control mode, for example closed loop control under constant pressure and closed loop control under constant tensile force.

F00.05=11: Simple PLC

Auxiliary frequency B is determined by output of Simple PID (refer to 7.9).

	<ol style="list-style-type: none"> 1. Main frequency source A and auxiliary frequency source B can not select the same physical channel (AI1-4/X7); 2. Process PID or simple PLC will be enabled only after being selected.
--	---

Function Code	Name of Function Code	Parameter Description	Unit	Default	Property
F00.06	Frequency Source Options	0: Main Frequency Source A 1: Auxiliary Frequency Source B 2: Main and Auxiliary Arithmetic Results 3: Switching between Main Frequency Source A and Auxiliary Frequency B 4: Switching between Main Frequency Source A and Main & Auxiliary Arithmetic Results 5: Switching between Auxiliary Frequency Source B and Main & Auxiliary Arithmetic Results		0	○

Select final frequency setting channel and arithmetic mode.

F00.06=0: Main Frequency Source A

Final setting frequency is only determined through main frequency source A.

F00.06=1: Auxiliary Frequency Source B

Final setting frequency is only determined through auxiliary frequency source B.

F00.06=2: Main and Auxiliary Arithmetic Results

Final setting frequency is determined through main and auxiliary arithmetic results (refer to F00.08).

F00.06=3: Switching between Main Frequency Source A and Auxiliary Frequency B

Final setting frequency is determined through input function “26: Frequency Source Switching”. If input function is disabled, final setting frequency is determined by main frequency source A; if input function is enabled, final setting frequency is determined by auxiliary frequency source B.

F00.06=4: Switching between Main Frequency Source A and Main & Auxiliary Arithmetic Results

Final setting frequency is determined through input function “26: Frequency Source Switching”. If input function is disabled, final setting frequency is determined by main frequency source A; if input function is enabled, final setting frequency is determined by main and auxiliary arithmetic results. See F00.08 for details.

F00.06=5: Switching between Auxiliary Frequency Source B and Main & Auxiliary Arithmetic Results

Final setting frequency is determined through input function “26: Frequency Source Switching”. If input function is disabled, final setting frequency is determined by the auxiliary frequency source A; if input function is enabled, final setting frequency is determined by main and auxiliary arithmetic results. See F00.08 for details.

Function Code	Name of Function Code	Parameter Description	Unit	Default	Property
F00.07	Numeric Frequency Setting	0.00 Hz - Maximum Frequency	Hz	50.00	●

F00.07 is used to set numeric frequency, with its maximum value limited by maximum frequency (F00.16).

Function Code	Name of Function Code	Parameter Description	Unit	Default	Property
F00.08	Main and Auxiliary Arithmetic	0: Main Frequency Source A + Auxiliary Frequency Source B 1: Main Frequency Source A - Auxiliary Frequency Source B 2: The Bigger of Main A and Auxiliary B 3: The Smaller of Main A and Auxiliary B		0	○

As for main and auxiliary arithmetic, final results are limited by both lower limit frequency (F00.19) and upper limit frequency (F00.18).

F00.08=0: Main Frequency Source A + Auxiliary Frequency Source B

Main and auxiliary arithmetic result is the sum (main frequency source A + auxiliary frequency source B); the result can be either a positive figure or a negative number. For example, the arithmetic result of 20.00 Hz (forward) and 40.00 Hz (reverse) is 20.00 Hz (negative).

F00.08=1: Main Frequency Source A - Auxiliary Frequency Source B

The arithmetic result is the difference between main frequency source A and auxiliary frequency source B, which can be positive or negative, take forward 20.00 Hz and reverse 40.00 Hz for example, the arithmetic result is 50.00 Hz given upper limit frequency F00.18=50.00.

F00.06=2: The Bigger of Main A and Auxiliary B

Main and auxiliary arithmetic result is the bigger of main frequency source A and auxiliary frequency source B; the result can be either positive or negative. For example, the arithmetic result of 20.00 Hz (forward) and 40.00 Hz (reverse) is 20.00 Hz (forward).

F00.06=3: The Smaller of Main A and Auxiliary B

Main and auxiliary arithmetic result is the smaller of main frequency source A and auxiliary frequency source B; the result can be either positive or negative. For example, the arithmetic result of 20.00 Hz (forward) and 40.00 Hz (reverse) is 40.00Hz (reverse).

Function Code	Name of Function Code	Parameter Description	Unit	Default	Property
F00.09	Reference Option for Auxiliary Frequency Source B at Main and Auxiliary Arithmetic	0: Relative to Maximum Frequency 1: Relative to Main Frequency Source A		0	○

At main and auxiliary arithmetic, range of auxiliary frequency source B follows object option, and default is maximum frequency. If selection corresponds to main frequency source A (F00.09=1), auxiliary frequency source B changes along with main frequency source A (default is to follow maximum frequency).

Function Code	Name of Function Code	Parameter Description	Unit	Default	Property
F00.10	Main Frequency Source Gain	0.0 - 300.0	%	100.0	●
F00.11	Auxiliary Frequency Source Gain	0.0 - 300.0	%	100.0	●
F00.12	Synthetic Gain of Main and Auxiliary Frequency	0.0 - 300.0	%	100.0	●
F00.13	Analogue Quantity Adjustment of Synthetic Frequency	0: Synthetic Frequency of Main and Auxiliary Channels 1: A11 * Synthetic Frequency of Main and Auxiliary Channels 2: A12 * Synthetic Frequency of Main and Auxiliary Channels 3: A13 * Synthetic Frequency of Main and Auxiliary Channels 4: A14 * Synthetic Frequency of Main and		0	○

Function Code	Name of Function Code	Parameter Description	Unit	Default	Property
		Auxiliary Channels 5: High-Frequency Pulse (PULSE) * Synthetic Frequency of Main and Auxiliary Channels			

Parameters above are mainly used to adjust the gain of various setting sources (refer to Figure 7-3). Both main frequency source A and auxiliary frequency source B have setting gain; there is synthetic gain by combination with selected function code F00.06. Final setting is limited by analog adjustment quantity, upper limit frequency and lower limit frequency.

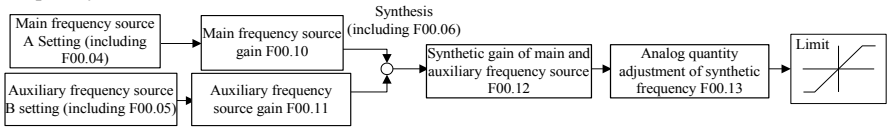

Figure 7-3 Frequency Source Setting Control (Gain Description)

Action mode of function codes about gain (F00.10 - F00.12) is “multiply”, i.e., “Setting=Former setting * gain”. The following will describe analog quantity adjustment of synthetic frequency (F00.13).

F00.13=0: Synthetic Frequency of Main and Auxiliary Channels

Synthetic frequency is directly set by synthetic frequency of main and auxiliary channels.

F00.13=1: AI1 * Synthetic Frequency of Main and Auxiliary Channels

F00.13=2: AI2 * Synthetic Frequency of Main and Auxiliary Channels

F00.13=3: AI3 * Synthetic Frequency of Main and Auxiliary Channels

F00.13=4: AI4 (Expansion Card) * Synthetic Frequency of Main and Auxiliary Channels

Synthetic frequency is determined through “AI (percentage) * Synthetic Frequency of Main and Auxiliary Channels”.

F00.13=5: High-Frequency Pulse (PULSE) * Synthetic Frequency of Main and Auxiliary Channels

Synthetic frequency is determined through “HDI (percentage) * Synthetic Frequency of Main and Auxiliary Channels”.

Please refer to the description of F00.04 for detailed explanations of AI1-AI4 and X7.

F00.04 has the same meanings as AI1-AI4 and X7. 100.00% is the percentage inputted through Synthetic Frequency of Main and Auxiliary Channels.

Function Code	Name of Function Code	Parameter Description	Unit	Default	Property
F00.14	Acceleration Time 1	0.00 - 650.00 (F15.13=0) 0.0 - 6500.0 (F15.13=1) 0 - 65000 (F15.13=2)	s	15.00	●
F00.15	Deceleration Time 1	0.00 - 650.00 (F15.13=0) 0.0 - 6500.0 (F15.13=1) 0 - 65000 (F15.13=2)	s	15.00	●

Acceleration time refers to the time required for output frequency going from 0.00Hz to acceleration/deceleration reference frequency Fbase, or the time required for output

frequency coming down from acceleration/deceleration reference frequency F_{base} to 0.00Hz; this has nothing to do with forward/reverse. See Figure 7-4.

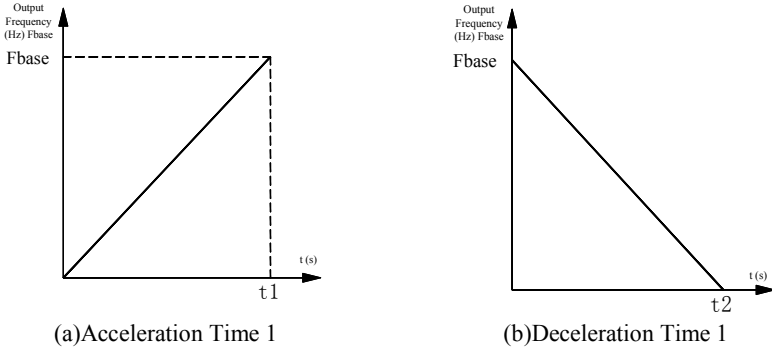



Figure 7-4 Acceleration/Deceleration Time

 Note: there are three acceleration/deceleration time units, 0.01 s, 0.1 s and 1 s, which are determined through F15.13.

Function Code	Name of Function Code	Parameter Description	Unit	Default	Property
F00.16	Maximum frequency	1.00 - 600.00	Hz	50.00	○

F00.16 is the maximum frequency allowed by inverter and denoted by F_{max} (range: 1.00 - 600.00 Hz).

Function Code	Name of Function Code	Parameter Description	Unit	Default	Property
F00.17	Upper Limit Frequency Control Options	0: Set through F00.18 1: AI1 2: AI2 3: AI3 4: AI4 (Expansion Card) 5: High-Frequency Pulse Input (X7) 6: Communication Percentage Setting 7: Communication Direct Setting		0	○
F00.18	Upper Limit Frequency	Lower Limit Frequency F00.19 - Maximum Frequency F00.16	Hz	50.00	●
F00.19	Lower Limit Frequency	0.00 - Upper Limit Frequency F00.18	Hz	0.00	●

F00.17=0: Set through F00.18

Under torque control mode, upper limit frequency is set through F00.18.

F00.17=1: AI1

F00.17=2: AI2

F00.17=3: AI3

F00.17=4: AI4 (Expansion Card)

Under torque control mode, upper limit frequency is set through AI (percentage) * F00.18.

F00.17=5: High-Frequency Pulse Input (X7)

Under torque control mode, upper limit frequency is set through HDI (percentage) * F00.18.

Please refer to the description of F00.04 for detailed explanations of AI1-AI4 and X7. F00.04 has the same meanings as AI1-AI4 and X7. 100.00% is the percentage inputted through F00.18 (Upper Limit Frequency).

F00.17=6 or 7: Communication Setting

Torque is determined by communication, etc.

- For master-slave communication (F10.05=1) and the inverter is slave (F10.06=0) upper limit frequency is set as “700FH (Main Frequency Setting by Communication) * F00.18 (upper limit frequency)* F10.08 (Receiving Proportionality Factor of Slave)”. The range of 700FH is -100.00% to 100.00%. See Table 12-2 for details.
- For general communication (F10.05=0)
 - a) For F00.17=6, upper limit frequency is “700AH (communication setting of upper limit frequency) * F00.18 (upper limit frequency)” .
 - b) For F00.17=7, upper limit frequency is “7017H (communication setting of upper limit frequency)” , set percentage is “700AH (Communication Setting of Upper Limit Frequency) * F00.18 (Upper Limit Frequency)”. Range of 700AH is 0.00% to 200.00%. See Table 12-2 for details.

F00.18 is the maximum operating frequency after inverter starts and denoted by Fup (range: Fdown - Fmax).

F00.19 is the minimum operating frequency after inverter starts and denoted by Fdown (range: 0.00 Hz - Fup).

	<ol style="list-style-type: none"> 1. Upper limit frequency and lower limit frequency shall be set carefully according to nameplate parameters and applications of the controlled motor. Otherwise, motor, after having worked for a long time at a low frequency, would lose its service life due to overheating. 2. The relationship among maximum frequency, upper limit frequency and lower limit frequency is: $0.00 \text{ Hz} \leq F_{\text{down}} \leq F_{\text{up}} \leq F_{\text{max}} \leq 600.00 \text{ Hz}$. 3. When set frequency is lower than F00.19 (lower limit frequency), running mode of inverter is determined through F15.33.
--	--

Function Code	Name of Function Code	Parameter Description	Unit	Default	Property
F00.20	Running Direction	0: Same 1: Opposite		0	●

By changing the function code, user may reverse motor rotation direction without changing motor wiring. Its function is the same as the switching of any two terminals of motor (U, V and W) in turning motor rotation direction.

	<ol style="list-style-type: none"> 1. After parameter initialization, running direction of motor will be restored to original status. 2. After system debugging, this function shall be used with caution for the
---	---

	<p>occasion where motor is not allowed to be reversed.</p> <p>3. This function is disabled, if inverter is not allowed to be reversed (for example F00.21=1).</p>
--	---

Function Code	Name of Function Code	Parameter Description	Unit	Default	Property
F00.21	Reverse Control	0: permit forward/reverse 1: prohibit reverse		0	○
F00.22	F/R Deadband Time	0.00 - 650.00	s	0.00	●

F00.21=0: Enabled

Rotation direction of motor can be controlled by set F/R terminal or F00.20.

F00.21=1: Disabled

If motor can run at one direction only, then neither terminal F/R nor F00.20 is enabled.

Select the status when motor switches between forward and reverse.

If F00.22=0.00, switch between forward and reverse completes smoothly.

If F00.22≠0, then inverter runs for the time as set through F00.22 at 0.00 Hz and runs at the reverse direction until set frequency is reached, after rotation speed decreases to 0.00 Hz at the time of switching between forward and reverse. See Figure 7-5.

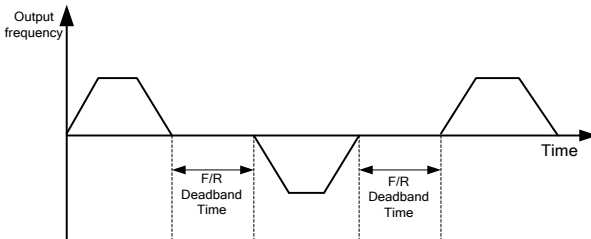

Figure 7-5 Forward/Reverse Deadband Time

	<p>If reverse is permitted, inverter judges direction according to status of terminal F/R and the value set through F00.20. If set forward direction is inconsistent with the wished motor direction, switch any two of inverter's output terminals U, V and W, or change F00.20 to an inverse value.</p>
--	---

Function Code	Name of Function Code	Parameter Description	Unit	Default	Property
F00.23	Carrier Frequency	1.0 - 16.0 (inverter rated power < 4.00 kW) 1.0 - 10.0 (inverter rated power 5.50 - 7.50 kW) 1.0 - 8.0 (inverter rated power 11.00 - 45.00 kW) 1.0 - 4.0 (inverter rated power 55.00 - 90.00 kW) 1.0 - 3.0 (inverter rated power 110.00 - 560.00 kW)	kHz	8.0-2.0	●

When carrier frequency is higher than the default value, increasing carrier frequency by 1 kHz requires load to decrease to some extent. Please set F00.24=1, and at this time, inverter will automatically adjust actual carrier frequency based upon actual application. It's recommend to set the the relationship between inverter's rated power and carrier frequency as shown in Table 7-2.

Table 7-2 Setting Relationship between Inverter Rated Power and Carrier Frequency

Inverter Frequency Pe	Pe≤4kW	5.5kW - 7.5kW	11kW - 45kW	55kW - 90kW	110kW - 560kW
Rated Carrier	8.0 kHz	6.0kHz	4.0kHz	2.0kHz	2.0kHz
Maximum Allowed Carrier	16.0 kHz	10.0kHz	8.0kHz	4.0kHz	3.0kHz

Function Code	Name of Function Code	Parameter Description	Unit	Default	Property
F00.24	Automatic Adjustment of Carrier Frequency	0: Disabled 1: Enabled		1	○

F00.24=0: Disabled

Carrier frequency is set through F00.23, limited by maximum carrier and will not change during running.

F00.24=1: Enabled

Carrier frequency set through F00.23 is affected by inverter temperature and load level. If inverter has an excessively high temperature or load, carrier wave will be limited. When set carrier frequency F00.23 is greater than limit value, limit value shall be used as carrier frequency of inverter.

Function Code	Name of Function Code	Parameter Description	Unit	Default	Property
F00.25	Carrier Frequency Noise Suppression	0: Disabled 1: Enabled		0	○
F00.26	Noise Suppression Tone	20 - 200	Hz	40	●
F00.27	Noise Suppression Intensity	10 - 150	Hz	100	●

When noise suppression function is enabled (F00.25=1), a sine wave may be superposed on the basis of set carrier wave (the frequency is set through F00.26 and intensity is set through F00.27), which may suppress present motor noise to some extent.

Function Code	Name of Function Code	Parameter Description	Unit	Default	Property
F00.28	Motor Parameter Group	0: Motor 1 Parameter 1: Motor 2 Parameter		0	○

EM600 inverter supports time interval based control of two motors, of which motor parameter and control parameter can be set separately. Motor 1 corresponds to parameters of F00, F01 and F06, and motor 2 corresponds to parameters of F14.

In combination with input function “30: Switch between Motor 1 and Motor 2”, F00.28 can be used to select present motor (see Table 7-3 for details).

Table 7-3 Motor Parameter Group Selection

F00.28: Motor Parameter Group	30: Switch between Motor 1 and Motor 2	Enabled Motor	Parameter Groups
0: Motor 1 Parameter	Disabled	Motor 1	F00/F01/F06
	Enabled	Motor 2	F14
1: Motor 2 Parameter	Disabled	Motor 2	
	Enabled	Motor 1	F00/F01/F06

Function Code	Name of Function Code	Parameter Description	Unit	Default	Property
F00.29	User Password	0 - 65535		0	○

F00.29 is used to set a new password to enable password protection function and avoid misoperation of function codes of inverter. If the new password is 0, then the password protection function is disabled. After setting the user password (none 0), in addition to the function code, all the parameters can only be viewed, cannot be modified.

7.2 F01 Group: Motor 1 Parameter

Function Code	Name of Function Code	Parameter Description	Unit	Default	Property
F01.00	Motor Type	0: Induction Motor 1: Inverter Induction Motor 2: Permanent Magnet Synchronous Motor		0	○

EM600 supports the induction motor and synchronous motor. Please set this parameter according to actual applications.

Function Code	Name of Function Code	Parameter Description	Unit	Default	Property
F01.01	Motor Rated Power	0.10 - 650.00	kW	Up To Specific Model	○
F01.02	Motor Rated Voltage	50 - 2000	V	Up To Specific Model	○
F01.03	Motor Rated Current	0.01 - 600.00 (Motor Rated Power ≤ 75kW) 0.1 - 6000.0 (Motor Rated Power >75kW)	A	Up To Specific Model	○
F01.04	Motor Rated Frequency	0.01 - 600.00	Hz	Up To Specific Model	○
F01.05	Motor Rated Speed	1 - 60000	rpm	Up To Specific Model	○
F01.06	Motor Winding Connection	0: Y 1: Δ		Up To Specific Model	○
F01.07	Motor Rated Power	0.600 - 1.000		Up To Specific	○

Function Code	Name of Function Code	Parameter Description	Unit	Default	Property
	Factor			Model	
F01.08	Motor Efficiency	30.0 - 100.0	%	Up To Specific Model	○

Function codes mentioned above are nameplate parameters of induction motor. For the first time when inverter is wired to motor, please set parameters above as per motor nameplate before inverter running, regardless of control mode, VF control mode or vector control mode.

When motor rated power (F01.01), inverter will modify values of parameters of F01.03 - F01.08 automatically. Please pay attention while using inverter.

Function Code	Name of Function Code	Parameter Description	Unit	Default	Property
F01.09	Stator Resistor of Induction Motor	1 - 60000 (Motor Rated Power \leq 75kW) 0.1 - 6000.0 (Motor Rated Power $>$ 75kW)	m Ω	Up To Specific Model	○
F01.10	Rotor Resistor of Induction Motor	1 - 60000 (Motor Rated Power \leq 75kW) 0.1 - 6000.0 (Motor Rated Power $>$ 75kW)	m Ω	Up To Specific Model	○
F01.11	Leakage Inductance of Induction Motor	0.01 - 600.00 (Motor Rated Power \leq 75kW) 0.001 - 60,000 (Motor Rated Power $>$ 75kW)	mH	Up To Specific Model	○
F01.12	Mutual Inductance of Induction Motor	0.1 - 6000.0 (Motor Rated Power \leq 75kW) 0.01 - 600.00 (Motor Rated Power $>$ 75kW)	mH	Up To Specific Model	○
F01.13	Idling Excitation Current of Induction Motor	0.01 - 600.00 (Motor Rated Power \leq 75kW) 0.1 - 6000.0 (Motor Rated Power $>$ 75kW)	A	Up To Specific Model	○

F01.09 - F01.13 are parameters of induction motor. However, user can not get these parameters generally. Please autotune motor parameters by using F01.34.

After motor parameters of F01.01 - F01.08 are modified, inverter will modify the parameters of F01.09 - F01.13. Please pay attention.

User must set parameters of F01.00 - F01.08 as per actual applications before motor parameter autotuning.

Meanings of motor parameters are illustrated in Figure 7-6:

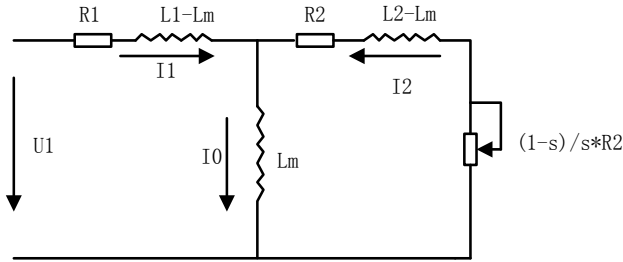

Figure 7-6 Induction Motor Stable Equivalent Model

In the figure, R1, L1, R2, L2, Lm and I0 refer to stator resistor, stator inductance, rotor resistor, rotor inductance, stator & rotor mutual inductance, and idling excitation current respectively.

Function Code	Name of Function Code	Parameter Description	Unit	Default	Property
F01.14	Induction Motor Field Weakening Factor 1	10.00 - 100.00	%	87.00	○
F01.15	Induction Motor Field Weakening Factor 2	10.00 - 100.00	%	80.00	○
F01.16	Induction Motor Field Weakening Factor 3	10.00 - 100.00	%	75.00	○
F01.17	Induction Motor Field Weakening Factor 4	10.00 - 100.00	%	72.00	○
F01.18	Induction Motor Field Weakening Factor 5	10.00 - 100.00	%	70.00	○

The field weakening factor of induction motor will be automatically set in motor parameter autotuning. Generally speaking, user does not set these factors.

Function Code	Name of Function Code	Parameter Description	Unit	Default	Property
F01.19	Stator Resistor of Synchronous Motor	1 - 60000 (Motor Rated Power ≤ 75kW) 0.1 - 6000.0 (Motor Rated Power >75kW)	mΩ		○
F01.20	d-Shaft Inductance of Induction Motor	0.01 - 600.00 (Motor Rated Power ≤ 75kW) 0.001 - 60.000 (Motor Rated Power >75kW)	mH	Up To Specific Model	○
F01.21	q-Shaft Inductance of Synchronous Motor	0.01 - 600.00 (Motor Rated Power ≤ 75kW) 0.001 - 60.000 (Motor Rated Power >75kW)	mH	Up To Specific Model	○
F01.22	Back Electromotive Force of Synchronous Motor	0.0 - 2000.0 (Back Electromotive Force of Rated Rotation Speed)	V	Up To Specific Model	○
F01.23	Initial Electric Angle of Synchronous Motor	0.0 - 359.9 (Synchronous motor enabled)			○

F01.09 - F01.13 are parameters of synchronous motor. However, user can not get these parameters generally. Please autotune motor parameters by F01.34. User must set parameters of F01.00 - F01.08 as per actual applications before motor parameter autotuning and make sure to select a proper type of motor (F01.00=2).

Function Code	Name of Function Code	Parameter Description	Unit	Default	Property
F01.24	Encoder Type	0: ABZ Incremental Encoder 1: UVW Incremental Encoder 2: UVW Wire-Saving Encoder 3: Not Used 4: Rotary Transformer		0	○

EM600 inverter supports multiple types of encoders. Different encoders shall be equipped with different PG cards, so please select a correct PG card (refer to Appendix II). After installation, set F01.24 correctly according to specific applications, otherwise inverter may run normally.

Function Code	Name of Function Code	Parameter Description	Unit	Default	Property
F01.25	Encoder Resolution	1 - 65535		1024	○

When inverter is in FVC control mode, user must set encoder line number correctly, otherwise motor will not run normally.

Function Code	Name of Function Code	Parameter Description	Unit	Default	Property
F01.26	Phase Angle of Zero Pulse of Encoder	0.0 - 359.9°		0.0	○

This parameter mainly applies to synchronous motor and can be set correctly by motor parameter autotuning.

Function Code	Name of Function Code	Parameter Description	Unit	Default	Property
F01.27	AB Pulse Phase Sequence	0: Forward 1: Reverse		0	○

For an encoder with AB signal (F01.24=0/1), if PG feedback frequency and set frequency are found with opposite directions during debugging, set F01.27 as 1 when F01.27 = 0 and set F01.27 as 0 when F01.27 = 1.

This parameter can be set correctly by motor parameter autotuning.

Function Code	Name of Function Code	Parameter Description	Unit	Default	Property
F01.28	Phase Sequence of UVW Encoder	0: Forward 1: Reverse		0	○
F01.29	UVW Initial Offset Phase Angle	0.0 - 359.9°		0.0	○

For an encoder with UVW signal (F01.24=0/3), if PG feedback frequency and set frequency are found with opposite directions during debugging, set F01.28 as 1 when F01.28 = 0 and set F01.28 as 0 when F01.28 = 1.

This parameter mainly applies to synchronous motor and can be set correctly by motor parameter autotuning.

Function Code	Name of Function Code	Parameter Description	Unit	Default	Property
F01.30	Rotary Transformer Pole-Pairs	1 - 65535		1	○

The rotary transformer has certain number of pole-pairs. While using this encoder, the parameters for pole-pairs must be set correctly.

Function Code	Name of Function Code	Parameter Description	Unit	Default	Property
F01.32	Speed Feedback Disconnection Detection Time	0.0 - 10.0 (0.0: Speed Feedback Disconnection Detection Disabled)		0.0	○
F01.33	Filter Time of Speed Feedback	0.000 - 0.100	s	0.002	○

F01.31=0: Disabled

Speed feedback disconnection protection function does not work.

F01.31=1: Enabled

When detecting feedback disconnection, inverter will report an encoder fault (22) after reaching the time set through F01.32.

F01.33 refers to filter time of speed feedback. There is no need to adjust it generally and default applies.

Function Code	Name of Function Code	Parameter Description	Unit	Default	Property
F01.34	Motor Parameter Autotuning	0: No Autotuning 1: Stationary Autotuning of Induction Motor 2: Rotational Autotuning of Induction Motor 3: Not Used 11: Stationary Autotuning of Synchronous Motor 12: Rotational Autotuning of Synchronous Motor 13: Autotuning of Encoder of Synchronous Motor		0	○

F01.34=0: No Autotuning

F01.34=1: Induction motor remains stationary in parameter autotuning.

User must set motor type (F01.00) and motor nameplate parameters (F01.01 - F01.08) correctly before stationary autotuning of induction motor. By stationary autotuning, user may can relevant parameters of induction motor, including F01.09 - F01.13.

This method mainly applies to application where motor can not rotate, but its effect is not as good as that of rotational autotuning.

F01.34=2: Induction motor remains rotational in parameter autotuning. Please release the load.

User must set motor type (F01.00) and motor nameplate parameters (F01.01 - F01.08) correctly before rotational autotuning of induction motor. By rotational autotuning, user can get relevant parameters of induction motor, including F01.09 - F01.13.

This method mainly applies to application where motor can rotate, but better not to have a load or better to have a light load in parameter autotuning, otherwise autotuning effect will go down.

F01.34=3: Not Used.

Synchronous motor has three autotuning methods. User may select one according to different applications. However, user must autotune parameters for a newly installed or replaced motor.

In VF control mode, user can only perform “12: Rotational Autotuning” or “11: Stationary Autotuning”, and input “Back Electromotive Force” (F01.22) manually; in FVC control mode, user can only perform “13: Autotuning of Encoder”; to further enhance control performance, user also needs to perform “12: Rotational Autotuning”.

F01.34=11: Synchronous motor remains stationary in parameter autotuning.

User must set motor type (F01.00) and motor nameplate parameters (F01.01 - F01.05) correctly before stationary autotuning of synchronous motor. By stationary autotuning, user may can relevant parameters of induction motor (F01.19 - F01.21), current loop parameters (F06.12 - F06.15), etc.

This method mainly applies to application where motor can not rotate and user needs to input “Back Electromotive Force” (F01.22) manually.



F01.34=2: Synchronous motor remains rotational in parameter autotuning.

User must set motor type (F01.00) and motor nameplate parameters (F01.01 - F01.05) correctly before rotational autotuning of synchronous motor. By rotational autotuning, user may can relevant parameters of synchronous motor (F01.19 - F01.21), current loop parameters (F06.12 - F06.15), back electromotive force of synchronous motor (F01.22), etc. This method mainly applies to application where motor can rotate, but better not to have a load or better to have a light load in parameter autotuning, otherwise autotuning effect will go down.

F01.34=13: Motor rotates slowly in encoder autotuning of synchronous motor.

User must set motor type (F01.00), motor nameplate parameters (F01.01 - F01.05), encoder type (F01.24) and encoder line number (F01.25) correctly before encoder autotuning of synchronous motor. For a rotary encoder, user must set the pole-pairs (F01.30). By encoder autotuning, user may can relevant parameters of synchronous motor (F01.19 - F01.21), encoder parameters (F01.26 - F01.29) and current loop parameters (F06.12 - F06.15).



1. Motor parameter autotuning is only enabled when inverter is in keypad start/stop control mode (F00.02=0): Motor parameter autotuning will start only by pressing , after F01.34 is set as a corresponding value and  is pressed for confirmation. After parameter autotuning, inverter will set F01.34 as 0 automatically.
2. Make sure to autotune parameters before inverter starts to run in FVC control, so as to achieve better control effect.
3. Please extend acceleration/deceleration time and try autotuning again, in case an overcurrent or overvoltage fault occurs during autotuning.
4. User must set encoder type (F01.24), encoder line number (F01.25) and pole-pairs of rotary voltage (F01.30, required when F01.24=4)

- before autotuning of inverter with an encoder. Phase parameters (F01.27 - F01.28) can be set manually or obtained by autotuning.
5. Motor parameters of the first group above are only taken as an example. For motor parameters of the second group, please refer to those parameters of the first group.

7.3 F02 Group: Input Terminal Parameter

EM600 inverter has 7 multi-functional input terminals (X1 - X7) and 3 analog quantity input terminals (AI1 - AI3, only enabled when corresponding function is the numeric input; refer to F02.31). In addition, user may select an IO expansion card (EC-IO-A1), which offers 4 multi-function numeric input terminals (X8 - X11) and 1 analog quantity voltage signal input terminal (AI4, with the same setting as AI1 - AI3).

Function Code	Name of Function Code	Parameter Description	Unit	Default	Property
F02.00	X1 Numeric Input Function	See Table 7-4 Functions of Numeric Multi-Function Input Terminals		1	○
F02.01	X2 Numeric Input Function			2	○
F02.02	X3 Numeric Input Function			11	○
F02.03	X4 Numeric Input Function			12	○
F02.04	X5 Numeric Input Function			13	○
F02.05	X6 Numeric Input Function			14	○
F02.06	X7 Numeric Input Function			10	○
F02.07	AI1 Numeric Input Function			0	○
F02.08	AI2 Numeric Input Function			0	○
F02.09	AI3 Numeric Input Function			0	○
F02.10	AI4 Numeric Input Function (Expansion Card)			0	○
F02.11	X8 Numeric Input Function (Expansion Card)			0	○
F02.12	X9 Numeric Input Function (Expansion Card)			0	○
F02.13	X10 Numeric Input Function (Expansion Card)			0	○
F02.14	X11 Numeric Input Function (Expansion Card)		0	○	

X1 - X11 and AI1 - AI4 are 15 numeric multi-function input terminals. By setting function codes F02.00 - F02.14, user can define the functions of those input terminals respectively. For example, if F02.00=1, X1 is "RUN". If terminal control (F00.02=1) is selected as command source, then inverter starts function RUN when X1 terminal input is valid. See Table 7-2 for specific function options.

Table 7-4 Numeric Multi-Function Input Terminals

Set Value	Function	Description
0	No Function	Set "0: No Function" for an unused or fault terminal to prevent false output.

Set Value	Function	Description
1	Run Terminal “RUN”	If terminal control (F00.02=1) is selected as command source, inverter executes function F/R according to setting value of terminal control mode F00.03 under application that function terminal is enabled. (See F00.03 Function Code)
2	R/F	If terminal control (F00.02=1) is selected as command source, inverter executes function F/R according to setting value of terminal control mode F00.03 under application that function terminal is enabled. (See F00.03 Function Code)
3	3-Wire Sequence Stop Control	If terminal control (F00.02=1) is selected as command source and terminal control mode is 3-wire sequence control (F00.03=2/3), inverter executes stop command under application that function terminal is enabled. (See F00.03 Function Code)
4	Forward JOG (FJOG)	If command source is selected as terminal control (F00.02=1), inverter runs forward under application that FJOG function terminal is enabled. Inverter runs reversely, if RJOG function terminal is enabled. If both FJOG and RJOG are enabled at the same time, inverter will ramp to stop. See Figure Table 7-20. ★ If reverse is prohibited, FJOG is disabled.
5	Reverse JOG (FJOG)	
6	UP	If function terminal UP is enabled, frequency offset will increase at speed defined through F12.11; if function terminal DOWN is enabled, frequency offset will decrease at speed defined through F12.11. If the UP/DOWN offset clear terminal is enabled, frequency offset will be cleared; Setting source of final frequency source A = Setting frequency of frequency source A + UP/DOWN offset. ★ The UP/DOWN function is only enabled when main frequency source A is involved in setting; offset frequency can be viewed through F18.15. Terminal UP/DOWN has the same function as UP/DOWN on keypad.
7	DOWN	
8	UP/DOWN Offset Clear	
9	Coast-to-Stop	
10	Fault Reset	This terminal can be used for reset if inverter fails and the failure is remedied. It has the same functions as the reset button on keypad.

Set Value	Function	Description																																								
11	Preset Speed Terminal 1	If inverter is in speed control mode and main frequency source A is involved in setting, user can define 4 function input terminals as preset speed terminals. The combined code of the 4 terminals, and setting of relevant function codes determine present frequency setting of inverter. As stated in the following table: (0/1: present function terminal disabled/enabled). See table 7-10. ★ If no option has been selected for input terminal of a function, default value is 0 (disabled).																																								
12	Preset Speed Terminal 2																																									
13	Preset Speed Terminal 3	<table border="1"> <thead> <tr> <th>14</th> <th>13</th> <th>12</th> <th>11</th> <th>Inverter Setting Frequency</th> </tr> </thead> <tbody> <tr> <td>0</td> <td>0</td> <td>0</td> <td>0</td> <td>Determined by main frequency source A (F00.04)</td> </tr> <tr> <td>0</td> <td>0</td> <td>0</td> <td>1</td> <td>Preset Speed 1 (F08.00)</td> </tr> <tr> <td>0</td> <td>0</td> <td>1</td> <td>0</td> <td>Preset Speed 2 (F08.01)</td> </tr> <tr> <td>0</td> <td>0</td> <td>1</td> <td>1</td> <td>Preset Speed 3 (F08.02)</td> </tr> <tr> <td>0</td> <td>1</td> <td>0</td> <td>0</td> <td>Preset Speed 4 (F08.03)</td> </tr> <tr> <td>0</td> <td>1</td> <td>0</td> <td>1</td> <td>Preset Speed 5 (F08.04)</td> </tr> <tr> <td>0</td> <td>1</td> <td>1</td> <td>0</td> <td>Preset Speed 6 (F08.05)</td> </tr> </tbody> </table>	14	13	12	11	Inverter Setting Frequency	0	0	0	0	Determined by main frequency source A (F00.04)	0	0	0	1	Preset Speed 1 (F08.00)	0	0	1	0	Preset Speed 2 (F08.01)	0	0	1	1	Preset Speed 3 (F08.02)	0	1	0	0	Preset Speed 4 (F08.03)	0	1	0	1	Preset Speed 5 (F08.04)	0	1	1	0	Preset Speed 6 (F08.05)
		14	13	12	11	Inverter Setting Frequency																																				
		0	0	0	0	Determined by main frequency source A (F00.04)																																				
		0	0	0	1	Preset Speed 1 (F08.00)																																				
		0	0	1	0	Preset Speed 2 (F08.01)																																				
		0	0	1	1	Preset Speed 3 (F08.02)																																				
		0	1	0	0	Preset Speed 4 (F08.03)																																				
		0	1	0	1	Preset Speed 5 (F08.04)																																				
0	1	1	0	Preset Speed 6 (F08.05)																																						
1	0	0	0	Preset Speed 7 (F08.06)																																						
1	0	0	0	Preset Speed 8 (F08.07)																																						
1	0	0	1	Preset Speed 9 (F08.08)																																						
1	0	1	0	Preset Speed 10 (F08.09)																																						
1	0	1	1	Preset Speed 11 (F08.10)																																						
1	1	0	0	Preset Speed 12 (F08.11)																																						
14	Preset Speed Terminal 4	1	1	0	1	Preset Speed 13 (F08.12)																																				
		1	1	1	0	Preset Speed 14 (F08.13)																																				
		1	1	1	1	Preset Speed 15 (F08.14)																																				
		With these two terminals, inverter can realize 4 preset PID settings. See the table below (0/1: present function terminal is disabled / enabled) or table 7-16.																																								
		16	15	Preset PID Setting																																						
		0	0	Determined by PID setting source (F09.00)																																						
16	Preset PID Terminal 2	0	1	Preset PID Setting 1 (F09.32)																																						
		1	0	Preset PID Setting 2 (F09.33)																																						
		1	1	Preset PID Setting 3 (F09.34)																																						
		With these two terminals, inverter can realize 4 torque settings. See the table below (0/1: present function terminal is disabled / enabled) or table 7-19.																																								
17	17	Preset Torque Setting																																								
18	Preset Torque Terminal 2	0	0	Determined by the torque setting source (F13.01)																																						
		0	1	Preset Torque 1 (F13.03)																																						
		1	0	Preset Torque 2 (F13.04)																																						

Set Value	Function	Description		
		1	1	Preset Torque 3 (F13.05)
19	Acceleration/Deceleration Time Terminal 1	EM600 inverter has four groups of acceleration/deceleration terminals, each group having two input terminals for acceleration and deceleration. The setting of combined code of the 4 terminals, and relevant functions determines present acceleration/deceleration time. As stated in the following table: (0/1: present function terminal disabled/enabled). See function codes F15.03 - F15.13.		
20	Acceleration/Deceleration Time Terminal 2	20	19	Acceleration/Deceleration Time
		0	0	Group 1 (Acceleration Time: F00.14, Deceleration Time: F00.15)
		0	1	Group 2 (Acceleration Time: F15.03, Deceleration Time: F15.04)
		1	0	Group 3 (Acceleration Time: F15.05, Deceleration Time: F15.06)
		1	1	Group 4 (Acceleration Time: F15.07, Deceleration Time: F15.08)
21	Acceleration/Deceleration Prohibited	If acceleration/deceleration time terminal is disabled, command for acceleration/deceleration is prohibited and inverter's output frequency remains the same. If inverter is under the overcurrent protection status, run inverter as per current limit mode.		
22	Pause Operation	Inverter ramps to stop, but all running parameters are memorized, for example PLC parameter, wobulation parameter and PID parameter. If terminal is disabled, inverter is reset to pre-stop running status.		
23	External Fault Input	Fault signal of external devices can be inputted through this terminal, so that inverter monitors and protects peripherals at fault. Upon receiving external fault signal, inverter displays "E 14", and coast to stop.		
24	Switch Run Command to Keypad	Priority rule is "24: Switch Run Command to Keypad" > "25: Switch Run Command to Communication" > "F00.02: Command Source" (see F00.02).		
25	Switch Run Command to Communication			
26	Frequency Source Switching	Mainly used with F00.06, and applied to switching of frequency source. This terminal works only when F00.06=3 - 5. See F00.06 for details.		
27	Clear Timed Run Time	This terminal is defined through F16.05 and used to clear the time that inverter has run for (reset remaining time of timed run). See F16.05 for details.		
28	Switch between Speed	Control mode of inverter is selected by these two		

Set Value	Function	Description
	Control and Torque Control	terminals and F13.00: if no. 28 terminal is enabled, control mode of inverter will switch between speed control and torque control; if no. 29 terminal is enabled, only speed control works.
29	Torque Control Disabled	
30	Switch between Motor 1 and Motor 2	This terminal and F00.28 are used together to determine present set motor: if no.30 terminal is enabled, switching can be completed based upon F00.28. See F00.28 for details.
31	Simple PLC Status Reset (Start to Run with Preset Speed 1, Clear Run Time)	When this terminal is enabled, simple PLC module will start to run again from the first preset speed. To further understand this function, user may view simple PLC description of F08.
32	Simple PLC Time Stop (Keep Running at Preset Speed)	When this terminal is enabled, simple PLC module will keep running at present speed; after it is disabled, simple PLC module will continue running after present speed stage is completed.
33	Zero Servo Command	Under control mode F00.01=2, inverter enters zero servo status if terminal is enabled at stop status; it resets to pre-start status after this terminal is disabled.
34	Count Input ($\leq 250\text{Hz}$)	Pulse input terminal with count function limits input pulse frequency to $\leq 250\text{Hz}$. Only one terminal can be set with this function. See F16.03 - F16.04 for details.
35	High-Speed Count Input ($\leq 100\text{kHz}$, Only Enabled for X7)	Pulse input terminal with count function limits input pulse frequency to $\leq 100\text{kHz}$. Only one terminal can be set with this function. See F16.03 - F16.04 for details.
36	Counter Clear	Clear counter that has counter function
37	Length Count Input ($\leq 250\text{Hz}$)	Pulse input terminal with length count function limits input pulse frequency to $\leq 250\text{ Hz}$. Only one terminal can be set with this function. See F16.01 - F16.02 for details.
38	High-Speed Length Count Input ($\leq 100\text{kHz}$, Only Enabled for X7)	Pulse input terminal with count function limits input pulse frequency to $\leq 100\text{kHz}$. This terminal is only enabled for X7 (i.e., F02.06=38). See F16.01 - F16.02 for details.
39	Length Clear	A length clear terminal with length count function.
40	Pulse Input ($\leq 100\text{kHz}$, Only Enabled for X7)	This is a pulse signal input terminal with input pulse frequency $\leq 100\text{kHz}$. It is only enabled for X7. ★ This function can not be used for special functions (for example, count). This terminal is only used as setting equivalent to AI percentage. If F00.04=5, then set F02.06=40 and set the frequency pulse through terminal X7.
41	Process PID Stop	When this terminal is enabled, then PID stops adjustment. At this time, the process maintains output. For more information, please refer to function code F09.18.
42	Process PID Integral Stop	When this terminal is enabled, integral adjustment

Set Value	Function	Description
		function of PID stops, but proportional adjustment and differential adjustment of PID are still enabled, so this function is called “integral separation”. See F09.20 for details.
43	PID Parameter Switching	PID parameter switch is completed by numeric input terminal (F09.11=2). If terminal is enabled, then PID parameters may be switched. See F09.05 - F09.13 for details.
44	PID Positive/Negative Reaction Switch	When terminal is enabled, inverter will switch between PID action mode and positive/negative reaction
45	Stop and DC Brake	Not to trigger stop command, and start braking when the start frequency of DC brake at stop (F04.20) is reached. The brake time shall be either terminal closing time or time of DC brake at stop (F04.22), see whichever is longer.
46	DC Brake at Stop	Not to trigger stop command, and start braking when the start frequency of DC brake at stop (F04.20) is reached after having received a stop command. The brake time shall be either terminal closing time or time of DC brake at stop (F04.22), see whichever is longer.
47	Immediate DC Brake	After this terminal is enabled, inverter stops and starts DC brake at present frequency immediately. Brake current is determined by DC Brake Current at Stop (F04.21).
48	Fatest Coast-To-Stop	When this terminal is enabled, inverter stops at permitted fatest acceleration/decleration time.
49	Not Used	
50	External Stop	Inverter stops as set stop mode (F04.19) and acceleration/deceleration 4 (F15.07/F15.08) when this terminal is enabled.
51	Switch Main Frequency Source to Numeric Frequency Setting	If this terminal is enabled, the main frequency source will be switched to corresponding setting under applications that the main frequency source A is involved in setting and inverter is not in preset speed mode; functions of 51 to 56 may work independently, but have a priority sequence. See Table 7-1 of F00.04 for details.
52	Switich Main Frequency Source to AI1	
53	Switich Main Frequency Source to AI2	
54	Switich Main Frequency Source to AI3	
55	Switch Main Frequency Source to High-Frequency Pulse Input	
56	Switch Main Frequency Source to Communication Setting	

Set Value	Function	Description
57	Inverter Enabled	If inverter meets other running applications and this terminal is enabled, then inverter can run; otherwise, inverter can not run if the inverter meets other running conditions but this terminal is disabled. ★ Enable inverter: if no terminal option is selected, the default is enabled; if there is only one terminal option, the selected terminal status works; if there are more than one terminal, this terminal will be disabled as long as one of the selected terminals is disabled.
58 - 68	Not Used	
69	Reverse Forbidden	When this Terminal is enabled, function is the same as F00.21=1
70 - 124	Not Used	

Function Code	Name of Function Code	Parameter Description	Unit	Default	Property
F02.15	Positive/Negative Logic 1 of Numeric Input Terminal	D7 D6 D5 D4 D3 D2 D1 D0		*00 00000	○
		* X7 X6 X5 X4 X3 X2 X1			
		0: Positive Logic, Enabled at On/Disabled at Off 1: Negative Logic, Disabled at On/Enabled at Off			
F02.16	Positive/Negative Logic 2 of Numeric Input Terminal	D7 D6 D5 D4 D3 D2 D1 D0		000 00000	○
		X11 X10 X9 X8 A14 A13 A12 A11			
		0: Positive Logic, Enabled at On/Disabled at Off 1: Negative Logic, Disabled at On/Enabled at Off			

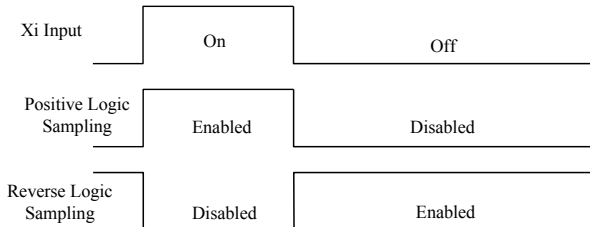

Figure 7-7 Terminal Positive and Negative Logic Sampling

0: Enabled when multi-function input terminal is on, disabled when multi-function input terminal is off;

1: enabled when multi-function input terminal is off, disabled when multi-function input terminal is on;

Such function codes are under bit operation. Set corresponding position as 0 or 1 while setting them. Take F02.15 as an example (see the table below):

Table 7-5 Function Code of Bit Operation

Set Item	*	X7	X6	X5	X4	X3	X2	X1
Corresponding Bit	7	6	5	4	3	2	1	0
Set Value	*	0/1	0/1	0/1	0/1	0/1	0/1	0/1

The 7th bit will not be used. This bit can not be set and the displayed value does not have any meaning.

For example: set X1 to negative logic by setting its corresponding bit 0 as 1, i.e.,

F02.15=xxx xxx1.

Set X1 and X6 to negative logic by setting corresponding bit 0 of X1 and corresponding bit of X6 as 1, i.e., 02.15=xx1 xxx1.

★ This function is used for matching with the logic of other peripherals.

Function Code	Name of Function Code	Parameter Description	Unit	Default	Property
F02.17	Numeric input terminal filter times	0 – 100, 0 means no filter, n means nms sampling for 1 time		2	○

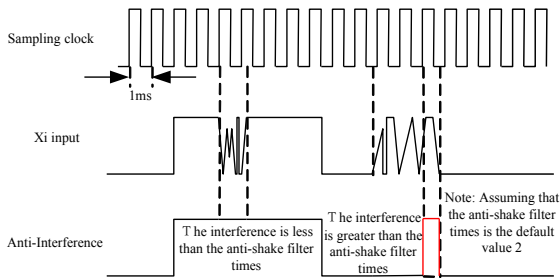

Figure 7-8 Terminal Filter Sampling

Because multi-function input terminals adopt level triggered mode or pulse triggered mode, when inverter is reading terminal status, multi-function input terminal signal has to be processed by digital filtering in order to avoid interference.

★ This code does not need to be adjusted on general applications. When an adjustment is required, please note the relations between filter times and lasting time when terminal is on. It is to avoid that inverter is easy to be interfered with due to insufficient filter times, or slow response or command loss due to too many filter times.

Function Code	Name of Function Code	Parameter Description	Unit	Default	Property
F02.18	X1 Effective Delay Time	0.000 - 30.000	s	0.000	●
F02.19	X1 Ineffective Delay Time	0.000 - 30.000	s	0.000	●
F02.20	X2 Effective Delay Time	0.000 - 30.000	s	0.000	●

Function Code	Name of Function Code	Parameter Description	Unit	Default	Property
F02.21	X2 Ineffective Delay Time	0.000 - 30.000	s	0.000	●
F02.22	X3 Effective Delay Time	0.000 - 30.000	s	0.000	●
F02.23	X3 Ineffective Delay Time	0.000 - 30.000	s	0.000	●
F02.24	X4 Effective Delay Time	0.000 - 30.000	s	0.000	●
F02.25	X4 Ineffective Delay Time	0.000 - 30.000	s	0.000	●

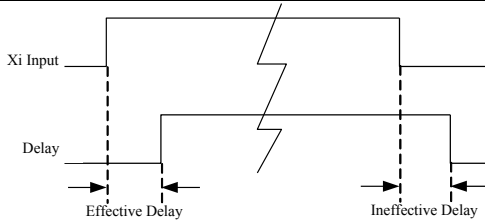

Figure 7-9 Terminal Delay Sampling

The terminal will delay to response according to function code setting, when function terminal status changes. At present, terminals X1 - X4 support this function. Specific actions: this function will be active after function terminal changes from disabled status to enabled status and the effective delay time is reached; this function terminal becomes inactive after function terminal changes from enabled status to disabled status and the ineffective delay time is reached.

★ If function code is set as 0.000s, the delay is disabled accordingly.

Function Code	Name of Function Code	Parameter Description	Unit	Default	Property
F02.26	Minimum Input Pulse Frequency	0.00 – Maximum Input Pulse Frequency F02.28	kHz	0.00	●
F02.27	Setting Corresponding to Minimum Input	-100.0 - +100.0	%	0.0	●
F02.28	Maximum Input Pulse Frequency	0.01 - 100.00	kHz	50.00	●
F02.29	Setting Corresponding to Maximum Input	-100.0 - +100.0	%	100.0	●
F02.30	Pulse Input Filter Time	0.00 - 10.00	s	0.10	●

EM600 inverter supports the high-speed pulse input (HDI) function, and terminal X7 is shared. F02.26 - F02.30 are used to set pulse filter time and corresponding offset curve. As indicated in Figure 7-10, the system realizes the line offset through setting of the two points (F02.26, F02.27) and (F02.28, F02.29) according to input pulse frequency size, and the input outside the frequency range will be cut off.

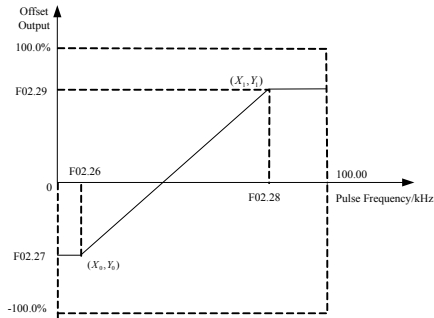

Figure 7-10 High-Speed Pulse Input Offset Curve

When input pulse frequency changes fast or the system does not need to make a quick response to the input pulse, user may properly increase the filter time to stabilize the system.

Function Code	Name of Function Code	Parameter Description	Unit	Default	Property
F02.31	Analog Input Function	<p>Ones place: AI1 0: Not Used 1: Numeric input (0 for less than 1V, 1 for over 3V, staying the same between 1V and 3V)</p> <p>Ten place: AI2 0: Not Used 1: Numeric input (the same as above)</p> <p>Hundreds place: AI3 0: Not Used 1: Numeric input (the same as above)</p>		0000D	○

Analog input terminals AI1 - AI4 of EM600 inverter can be used as numeric terminals. User only needs to set them as 1. If terminal AI2 is used as a numeric terminal, i.e., F02.31=xx1x, its analog input and numeric logic are switched as follows:
 When terminal input voltage <1V, corresponding logic status is disabled;
 When terminal input voltage >3V, the corresponding logic status is enable;
 When terminal input voltage falls between 1V and 3V, corresponding logic remains.

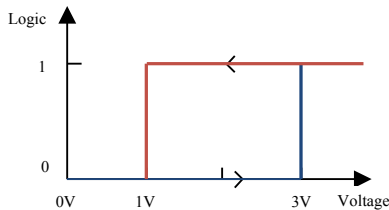

Figure 7-11 Analog Input Terminal Voltage and Present Logic Status Relationship Diagram

If terminal is used as an analog input terminal, user may set the filter time and corresponding offset curve through F02.32 - F02.60. AI1 - AI4 can be set respectively.

Function Code	Name of Function Code	Parameter Description	Unit	Default	Property
F02.32	Analog Input Curve Options	Ones Place: AI1 Curve 0: Curve 1 1: Curve 2 2: Curve 3 3: Curve 4 Tens Place: AI2 Curve 0: Curve 1 1: Curve 2 2: Curve 3 3: Curve 4 Hundreds Place: AI3 Curve 0: Curve 1 1: Curve 2 2: Curve 3 3: Curve 4 Thousands Place: AI4 Curve 0: Curve 1 1: Curve 2 2: Curve 3 3: Curve 4		3210D	○
F02.33	Minimum Input of Curve 1	0.00 - F02.35	V	0.10	●
F02.34	Setting Corresponding to Minimum Input of Curve 1	- 100.0 - +100.0	%	0.0	●
F02.35	Maximum Input of Curve 1	F02.33 - 10.00	V	9.90	●
F02.36	Setting Corresponding to Maximum Input of Curve 1	- 100.0 - +100.0	%	100.0	●
F02.37	Minimum Input of Curve 2	-10.00 - F02.39	V	0.10	●
F02.38	Setting Corresponding to Minimum Input of Curve 2	- 100.0 - +100.0	%	0.0	●
F02.39	Maximum Input of Curve 2	F02.37 - 10.00	V	9.90	●
F02.40	Setting Corresponding to Maximum Input of Curve 2	- 100.0 - +100.0	%	100.0	●
F02.41	Minimum Input of Curve 3	0.00 - F02.43	V	0.10	●
F02.42	Setting Corresponding to Minimum Input of Curve 3	- 100.0 - +100.0	%	0.0	●
F02.43	Input of Inflection 1 of Curve 3	F02.41 - F02.45	V	2.50	●

Function Code	Name of Function Code	Parameter Description	Unit	Default	Property
F02.44	Setting Corresponding to Input of Inflexion 1 of Curve 3	-100.0 - +100.0	%	25.0	●
F02.45	Input of Inflexion 2 of Curve 3	F02.43 - F02.47	V	7.50	●
F02.46	Setting Corresponding to Input of Inflexion 2 of Curve 3	-100.0 - +100.0	%	75.0	●
F02.47	Maximum Input of Curve 3	F02.45 - 10.00	V	9.90	●
F02.48	Setting Corresponding to Maximum Input of Curve 3	-100.0 - +100.0	%	100.0	●
F02.49	Minimum Input of Curve 4	-10.00 - F02.51	V	-9.90	●
F02.50	Setting Corresponding to Minimum Input of Curve 4	-100.0 - +100.0	%	-100.0	●
F02.51	Input of Inflexion 1 of Curve 4	F02.49 - F02.53	V	-5.00	●
F02.52	Setting Corresponding to Input of Inflexion 1 of Curve 4	-100.0 - +100.0	%	-50.0	●
F02.53	Input of Inflexion 2 of Curve 4	F02.51 - F02.55	V	5.00	●
F02.54	Setting Corresponding to Input of Inflexion 2 of Curve 4	-100.0 - +100.0	%	50.0	●
F02.55	Maximum Input of Curve 4	F02.53 - 10.00	V	9.90	●
F02.56	Setting Corresponding to Maximum Input of Curve 4	-100.0 - +100.0	%	100.0	●
F02.57	AI1 Filter Time	0.00 - 10.00	s	0.10	●
F02.58	AI2 Filter Time	0.00 - 10.00	s	0.10	●
F02.59	AI3 Filter Time	0.00 - 10.00	s	0.10	●
F02.60	AI4 Filter Time (Expansion Card)	0.00 - 10.00	s	0.10	●

F02.32 is used to select offset curve corresponding to each analog quantity input terminal and there are 4 groups of offset curves available for selection. Of the 4 groups of curves, curves 1 and 2 are of two-point offset type, and curves 3 and 4 are of four-point offset type; the minimum input voltage of curves 2 and 4 can be as low as -10V and meet requirements of AI4 input. After having selected offset curve, user can set corresponding function code to meet input requirements. It shall have the same meanings as HDI. See F02.26 - F02.29 for details.

User can properly adjust filter time according to analog input status and actual working condition. Please refer to actual result.

Function Code	Name of Function Code	Parameter Description	Unit	Default	Property
F02.61	AD Sampling Hysteresis	2 - 50		2	○

User can properly increase the function code, if input fluctuates greatly due to analog quantity input hysteresis, long input line or severe field interference. The principle of adjustment is to reduce adjustment as possible.

7.4 F03 Group: Output Terminal Function Parameter

EM600 inverter has 2 multi-functional input terminals (Y1 and Y2) and 2 relay output terminals (R1 and R2). In addition, IO expansion card (EC-IO-A1) is optional and offers 1 multi-functional input output terminals (Y3).

Function Code	Name of Function Code	Parameter Description	Unit	Default	Property
F03.00	Y1 Output Function	See Table 7-6 Functions of Numeric Multi-Function Input Terminals		1	○
F03.01	Y2 Output Function			3	○
F03.02	R1 Output Function			7	○
F03.03	R2 Output Function			8	○
F03.04	Y3 Output Function (Expansion Card)			0	○

Y1 – Y3, R1 and R2 are 5 numeric multi-function output terminals. By setting function codes F03.00 - F03.04, user can define the functions of output terminals respectively. For example, if F03.02=7, function of terminal R1 is “inverter fault”. If inverter is in fault status, R1 is in active output status; if inverter is normal status, R1 is in inactive output status. Specific functions available are shown in Table 7-6.

Table 7-6 Numeric Multi-Function Output Terminals

Set Value	Function	Description
0	No Output	Set “0: No Function” for an unused or fault terminal to prevent false output.
1	Inverter Running (RUN)	When inverter is in slave running, slave stop, JOG running or JOG stop status, present output is active; in other status, present output is inactive.
2	Frequency Reach Range (FAR)	When inverter is in running status and absolute value of “output frequency – set frequency” \leq frequency reach detection width (F15.20), present output is active; when inverter is not in running status or absolute value of “output frequency – set frequency” $>$ frequency reach range (F15.20), present output is inactive. See function code F15.20 for details.
3	Output Frequency Detection Range FDT1	When inverter is in running status, and absolute value of output frequency $>$ output frequency detection range FDT1 (F15.21), then present output is active; when inverter is not in running status, or absolute value of output frequency \leq output frequency detection range FDT1 (F15.21) - hysteresis FDT1 (F15.22), present output is inactive; for other status, present output status remains unchanged. See the Function Codes F15.21 and F15.22 for details.
4	Output Frequency Detection Range FDT2	When inverter is in running status, and absolute value of output frequency $>$ output frequency detection range FDT1 (F15.23), then present output is active; when inverter is not

Set Value	Function	Description
		in running status, or absolute value of output frequency \leq output frequency detection range FDT2 (F15.23) - hysteresis FDT1 (F15.24), present output is inactive; for other status, present output status remains unchanged. See function codes F15.23 and F15.24 for details.
5	Reverse Running (REV)	When running direction and acceleration/deceleration status of inverter are reverse acceleration, reverse deceleration or reverse constant speed, present output is active.
6	JOG Running	When inverter is in JOG running or JOG stop status, present output is active.
7	Inverter Fault	When inverter is in fault status, present output is active; in other status, present output is inactive.
8	Inverter Ready	When inverter is ready for running after it is powered on and finishes initialization without any fault, present output is active.
9	Upper Limit Frequency Reach	When inverter is in JOG or slave running status, output frequency (F18.00) \geq upper limit frequency (F00.17 F00.18) and set frequency (F18.01) \geq upper limit frequency (F00.17 F00.18), present output is active. Otherwise, present output is inactive.
10	Lower Limit Frequency Reach	When inverter is in JOG or slave running status, output frequency (F18.00) \leq lower limit frequency (F00.19) and set frequency (F18.01) \leq lower limit frequency (F00.19), present output is active. Otherwise, present output is inactive.
11	Current Limit Reach	When output current (F18.06) \geq current limit level (F07.12), present output is active. When output current (F18.06) \leq current limit level (F07.12) -5.0%, present output is inactive. When the voltage is the intermediate value, present output status remains the same.
12	Overtoltage Stall Voltage Reach	When output voltage (F18.07) \geq Overtoltage stall control voltage (F07.07), present output is active. When output voltage (F18.07) \leq Overtoltage stall control voltage (F07.07) -10V, present output is inactive. When the voltage is the intermediate value, present output status remains the same.
13	Simple PLC Cycle Finished	When simple PLC running mode is "stop after single running" (F18.15=0), inverter stops after single running, and present output is active; when simple PLC running mode is "stop after limited times of running" (F18.15=1), inverter stops after running as per F08.16, present output is active; otherwise (run again, simple PLC status reset, etc.), present output is inactive.
14	Set Count Value Reach	When input pulse count value (F18.34) \geq set count value (F16.03), present output is active, otherwise output is

Set Value	Function	Description
		inactive. See function codes F16.03 - F16.04 for details.
15	Designated Count Value Reach	When input pulse count value (F18.34) \geq designated count value (F16.04), present output is active, otherwise output is inactive. See function codes F16.03 - F16.04 for details.
16	Length Reach	When the input pulse conversion value (F18.34) \geq set count value (F16.01), present output is active, otherwise output is inactive. See function codes F16.01 - F16.02 for details.
17	Motor Overload Pre-alarms	When present motor current \geq motor pre-alarms factor (F07.02), present output is active. Otherwise, output is inactive.
18	Inverter Overheating Pre-Alarm	When inverter temperature \geq overheat spot -25°C , the pre-alarms output is active, otherwise the pre-alarms output is inactive.
19	PID Feedback Upper Limit Reach	If PID feedback (F18.17) \geq upper limit of PID output (F09.16) when inverter is running, present output is active. Otherwise, present output is inactive.
20	PID Feedback Lower Limit Reach	If PID feedback (F18.17) \leq lower limit of PID output (F09.17) when inverter is running, present output is active. Otherwise, present output is inactive.
21	Analog Quantity Level Detection ADT1	If selected analog quantity channel input \geq analog quantity level detection (F15.26/28), corresponding output is active; if selected analog quantity channel input \leq analog quantity level detection (F15.26/28) – hysteresis (F15.27/29), present output is inactive; When inverter is in other status except the two above, present output status remains the same. See F15.25 - F15.29 for details.
22	Analog Quantity Level Detection ADT2	
23	Zero Servo	If inverter is in zero servo control mode, present output is active. Otherwise, present output is inactive.
24	Undervoltage Status	When DC bus voltage (F18.08) \leq undervoltage stall control voltage (F07.08), present output is active. When DC bus voltage (F18.08) \geq judgment operation voltage at power failure ending (F07.09), and maintenance time \geq judgment delay time at power failure ending (F07.10), present output is inactive.
25	Motor Overload Pre-alarms	When present motor temperature (F18.38) \geq motor overheating pre-alarms threshold (F07.05), present output is active. Otherwise, output is inactive. See F07.03 - F07.05 for details.
26	Set Time Reach	When timed run time is reached, present output is active. Otherwise, present output is inactive.
27	Run at Zero Speed	When inverter is in JOG or slave running status, and output frequency (F18.00) \leq zero servo start frequency (F04.29), present output is active. Otherwise, present output is inactive.
28 – 35	Not Used	

Set Value	Function	Description
36	Position Fix	Position control mode the current location and reference errors in the positioning range between F30.11 and maintenance of positioning time is greater than the time of completion of F30.12, the output is valid.
37 – 68	Not Used	
69	FDT1 Lower Limit Frequency (Pulse)	It is the same like set value 3/4 but the difference is only when the frequency is lower than "set-hysteresis", the output becomes valid, and maintained automatically after a period of time is not valid. If set to single pulse output, the time set by the F03.17~F03.20 if the output level output, the time defaults to 0.1s.
70	FDT2 Lower Limit Frequency (Pulse)	
71	FDT1 Lower Limit Frequency (Pulse, Disabled when JOG)	
72	FDT2 Lower Limit Frequency (Pulse, Disabled when JOG)	It is the same like set value 69/70 but the difference is there is no output on JOG.

If the two multi-function output ports are of OC output type and the common terminal of output is COM. If selected function is inactive, electronic switch is OFF; if selected function is active, electronic switch is ON. OC can be powered by internal power supply, as shown in Figure 7-12 (a), or by external power supply, as shown in Figure 7-12 (b). For external power supply, required voltage range is 12 - 30 V.

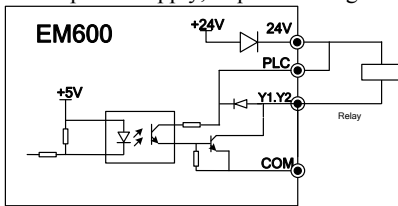

a) Internal Power Supply

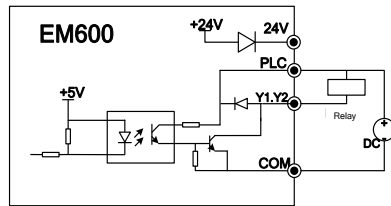

b) External Power Supply

Figure 7-12 Power Supply Mode of Multi-Function Terminal

Relay output is provided by internal relay of inverter; the relay has 1 group of NO contacts and 1 group of NC contacts; when selected function is inactive, EB-EC is NC and EA-EC is NO (Refer to Figure 7-13); when selected function is active, internal relay coil is powered on, EB-EC is off and EA-EC is on.

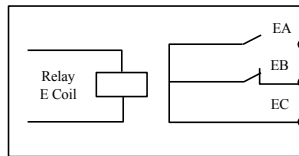

Figure 7-13 Relay Contactor

Function Code	Name of Function Code	Parameter Description	Unit	Default	Property
---------------	-----------------------	-----------------------	------	---------	----------

F03.05	Output Signal Type	D7	D6	D5	D4	D3	D2	D1	D0	*0000	○
		*	*	*	*	R2	R1	Y2	Y1		
		0: Level 1: Monopulse									

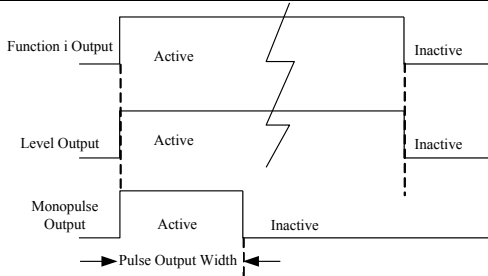

Figure 7-14 Numeric Output Terminal Level and Monopulse Output

Numeric output terminals Y1 and Y2, and relay output terminals R1 and R2 have two output types, level and monopulse (see Figure 7-14). For level output, function terminal’s output status is consistent with its function status; for monopulse output, active level of certain pulse width can be outputted only when the function is enabled. This function code is of bit operation type. For specific settings, please refer to table 7-5 of the description part for F02.15.

Function Code	Name of Function Code	Parameter Description	Unit	Default	Property						
F03.06	Positive/Negative Logic of Numeric Output	D7	D6	D5	D4	D3	D2	D1	D0	00000	○
		*	*	*	Y3	R2	R1	Y2	Y1		
		0: Positive Logic, Enabled at On/Disabled at Off 1: Negative Logic, Disabled at On/Enabled at Off									

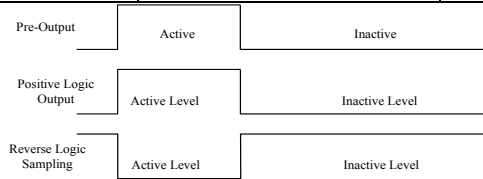

Figure 7-15 Positive and Negative Logic Output of Numeric Output Terminal

According to design, numeric multi-function output terminal status has two output logics:
 0: Positive logic, if the function is on, multi-function output terminal outputs active level; if the function is off, multi-function output terminal outputs inactive level.
 1: Negative logic, if the function is on, multi-function output terminal outputs inactive level; if the function is off, multi-function output terminal outputs active level.
 This function code is of bit operation type. For specific settings, please refer to table 7-5 of F02.15.

★ This function is used for matching with the logic of other peripherals.

Actual level: Y1/Y2, default active level is low level; default actual level of R1/R2 is high level.

Function Code	Name of Function Code	Parameter Description	Unit	Default	Property
F03.07	Y2 Output Type	0: Common Numeric Output 1: High-Frequency Pulse Output		0	○

EM600 inverter supports high-speed pulse output (HDO) function, which is similar to analog quantity output function. Output quantity of inverter is in pulse of different frequency sizes other than voltage values.

Function Code	Name of Function Code	Parameter Description	Unit	Default	Property
F03.08	Output Status Control at JOG	D7 D6 D5 D4 D3 D2 D1 D0		00000	○
		* * * REV FDT2 FDT1 FAR RUN			
		0: Enabled at JOG 1: Disabled at JOG			

When inverter is in jog running, user does not need DO to output some status, so setting this function code as 1 to shield corresponding output. If F03.08=xxx1x when FAR is in active output status, then actually selected output terminal does not output active level. This function code is of bit operation type. For specific settings, please refer to table 7-5 of F02.15.

Function Code	Name of Function Code	Parameter Description	Unit	Default	Property
F03.09	Y1 Effective Delay Time	0.000 - 30.000	s	0.000	●
F03.10	Y1 Ineffective Delay Time	0.000 - 30.000	s	0.000	●
F03.11	Y2 Effective Delay Time	0.000 - 30.000	s	0.000	●
F03.12	Y2 Ineffective Delay Time	0.000 - 30.000	s	0.000	●
F03.13	R1 Effective Delay Time	0.000 - 30.000	s	0.000	●
F03.14	R1 Ineffective Delay Time	0.000 - 30.000	s	0.000	●
F03.15	R2 Effective Delay Time	0.000 - 30.000	s	0.000	●
F03.16	R2 Ineffective Delay Time	0.000 - 30.000	s	0.000	●

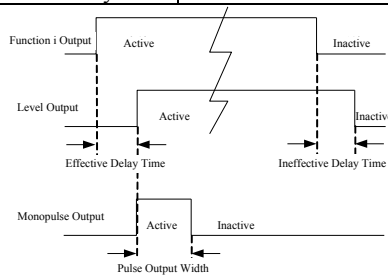

Figure 7-16 Numeric Output Terminal Level and Monopulse Output

The terminal will delay to response according to function code setting, when function terminal changes. At present, terminals Y1/Y2 and R1/R2 support this function. Specific actions: corresponding output terminal outputs active level only when function terminal changes from disabled status to enabled status and the effective delay time is reached; corresponding output terminal outputs inactive level only when function terminal changes from enabled status to disabled status and the ineffective delay time is reached.

★: If function code is set as 0.000s, the delay is disabled accordingly.

Function Code	Name of Function Code	Parameter Description	Unit	Default	Property
F03.17	Y1 Output Monopulse Time	0.000 - 30.000	s	0.250	●
F03.18	Y2 Output Monopulse Time	0.000 - 30.000	s	0.250	●
F03.19	R1 Output Monopulse Time	0.000 - 30.000	s	0.250	●
F03.20	R2 Output Monopulse Time	0.000 - 30.000	s	0.250	●

When output type of function output terminal is monopulse output (see F03.05), user can control active level pulse width by setting monopulse output time to meet various process or control requirements. See Figure 7-14 and Figure 7-16 for details.

Function Code	Name of Function Code	Parameter Description	Unit	Default	Property
F03.21	Analog Output M1	See Table 7-7 Multi-Function Analog Output Terminals		0	○
F03.22	Analog Output M2			2	○
F03.23	Y2 High-Frequency Pulse Output Function			11	○

M1 and M2 are 2 multi-function analog output terminals and Y2 can be set as a high-speed pulse output terminal (F03.07=1). By setting function codes F03.21 - F03.23, user can define the functions of output terminals.

For example, if F03.21=0, function of M1 terminal is to output “Running frequency (absolute value)”, and reflects present value of “Running frequency” (absolute value)” by outputting different voltage values. If running frequency increases from 0.00 Hz to 50.00 Hz (assuming F00.16=50.00), then default application is that M1 output voltage increases from 0.00V to 10.00 V, with the same variation trend as that of running frequency. Specific functions available are shown in Table 7-7.

Table 7-7 Multi-Function Analog Output Terminals

Set Value	Function	Description
0	Running frequency (absolute value)	0.00 Hz - Fmax, corresponding output 0.0% - 100.0%
1	Set frequency (absolute value)	0.00 Hz - Fmax, corresponding output 0.0% - 100.0%
2	Output torque (absolute value)	0.0% - 200.0%, corresponding output 0.0% - 100.0%
3	Set torque (absolute value)	0.0% - 200.0%, corresponding output 0.0% - 100.0%
4	Output Current	0.0A - 2*Ie, corresponding output 0.0% - 100.0%
5	Output Voltage	0.0V - 1.5*Ue, corresponding output 0.0% - 100.0%
6	Bus voltage	0V - 1000V, corresponding output 0.0% - 100.0%
7	Output Power	0.00kW - 2*Pe, corresponding output 0.0% - 100.0%
8	AI1	Output actual input voltage, other than results after offset 100.0%, corresponding output 0.0% - 100.0%
9	AI2	
10	AI3	
11	AI4 (Expansion Card)	
12	High-Speed Pulse Input	F02.26 - F02.28, corresponding output 0.0% - 100.0%
14	Value of Count	0~F16.03 is corresponding to F16.10~F16.11
15	Value of Length	0~F16.03 is corresponding to F16.10~F16.11

★: Fmax, Maximum Frequency (F00.16)

Ie, Inverter Rated Current (F12.21)

Ue, Inverter Rated Voltage (F12.20)

Pe, Inverter Rated Power (F12.19)

Output physical quantity of analog output terminal can be switched through DIP between voltage signal 0.00V - 10.00 V and current signal 0.00mA - 20.00mA. For voltage signal, 0.0% - 100.0% corresponds to output 0.00V - 10.00 V; for current signal, 0.0% - 100.0% corresponds to 0.00mA - 20.00mA. See 3.3.7 Analog Output Terminal Wiring.

Function Code	Name of Function Code	Parameter Description	Unit	Default	Property
F03.27	M1 Output Offset	-100.0 - 100.0	%	0.0	●
F03.28	M1 Output Gain	-10.00 - 10.00		1.00	●
F03.29	M2 Output Offset	-100.0 - 100.0	%	0.0	●
F03.30	M2 Output Gain	-10.00 - 10.00		1.00	●

These function codes are used to correct zero shift and output amplitude deviation of analog output generally, and they can be also used to define desired AO output curve to meet different instrument or other requirements. If use “b” for offset, “k” for gain, “Y” for actual output, and “X” for standard output, then actual output is: $Y=kX + b$.

	<ol style="list-style-type: none"> In order to meet the requirements of various instruments or peripherals, full-scale voltage of M1 and M2 is 10.9V actually and full-scale current is 22mA actually. Default settings of M1 and M2 are 0.00 - 10.00 V. Please use a multimeter to test idling output of terminals M1 and M2, if there is high requirement on the accuracy of analog output.
---	--

7.5 F04 Group: Start/Stop Control Parameter

Function Code	Name of Function Code	Parameter Description	Unit	Default	Property
F04.00	Start Mode	0: Start Directly 1: Rotation Speed Tracking Start		0	○

F04.00=0: Start Directly

Inverter starts with DC brake (not available if F04.04=0), conducts pre-excitation (not available if F04.07=0), starts at start frequency, and enters set frequency running after retention time of start frequency.

F04.00=1: Rotation Speed Tracking Start

Inverter will first perform rotation speed tracking (size and direction) at startup, and start up smoothly from actual rotation frequency of present motor.

Function Code	Name of Function Code	Parameter Description	Unit	Default	Property
F04.01	Start Frequency	0.00 - 10.00	Hz	0.00	○
F04.02	Start Frequency Retention time	0.00 - 60.00, Disabled at 0.00	s	0.00	○

Set appropriate start frequency, in order to guarantee motor torque at start. In order to enable motor to make magnetic flux fully, it's required to maintain motor's start frequency for certain time. Start frequency F04.01 is not limited by lower limit frequency.

Function Code	Name of Function Code	Parameter Description	Unit	Default	Property
F04.03	DC Brake Current at Start	0.0 - 100.0 (100.0= Motor Rated Current)	%	100.0	○
F04.04	DC Brake Time at Start	0.00 - 30.00	s	0.00	○
F04.05	DC Brake Field Weakening Time at Start	0.00 - 30.00	s	0.50	○

Before inverter starts, motor can run at low speed or reverse. Starting inverter at this time immediately can result in overcurrent fault. In order to avoid such a fault, add the link of DC brake at first prior to inverter start to stop motor, and then start inverter to set frequency according to set direction.

Different values of F04.03 may realize different start DC brake torques.

By setting the action time of DC brake through F04.04, inverter starts immediately after set time is out. If F04.04=0.00, DC brake is disabled at start.

★ The process of starting DC brake is shown in Figure 7-18.

	This function may be enabled when single inverter serves multiple motors and inverter is starting.
--	--

Function Code	Name of Function Code	Parameter Description	Unit	Default	Property
F04.06	Pre-Excitation Current	50.0 - 500.0 (100.0=Idling Current)	%	100.0	○
F04.07	Pre-Excitation Time	0.00 - 10.00	s	0.10	○

Inverter develops a magnetic field as set pre-excitation current, and starts running after set pre-excitation time (F04.07) are out. If set pre-excitation is 0, inverter will start directly without the pre-excitation link.

F04.06 pre-excitation current is a percentage relative to motor's no load current.

Function Code	Name of Function Code	Parameter Description	Unit	Default	Property
F04.08	Rotation Speed Tracking Method	0: Start from Maximum Frequency 1: Start from Stop Frequency 2: Start from Grid Frequency		0	○

When starting mode is selected as torque tracking start (F04.00=1), inverter will perform torque tracking as per setting through F04.08 at start. Please select a proper mode according to application, so as to better track present motor running frequency.

This mode can be selected when inverter starts tracking downwards from maximum frequency (F04.08=0) and running status of motor is completely unsure (motor is in rotation status when inverter is powered on).

If F04.08=1, it means that inverter starts tracking from stop frequency. Generally, this mode is selected;

If F04.08=2, it means that inverter starts tracking from grid frequency. This mode can be selected if grid frequency changes to frequency conversion.

Function Code	Name of Function Code	Parameter Description	Unit	Default	Property
F04.09	Not Used	-	-	-	-
F04.10	Deceleration Time of Rotation Speed Tracking	0.1 - 20.0	s	2.0	○
F04.11	Rotation Speed Tracking Current	30.0 - 150.0 (100.0=Inverter Rated Current)	%	60.0	●
F04.12	Rotation Speed Compensation Gain	1.00 - 1.30		1.05	●

F04.10: The scanning speed starting from set frequency to downward tracking at torque tracking; this time refers to the period that the rated frequency decreases to 0.00 Hz.

F04.11: Tracking current, which is a ratio relative to inverter rated current. The lower the current is, the smaller the impact of motor will be, so is tracking accuracy. However, if current is set at an excessively low value, the tracking results may be inaccurate, which result in the start failure. The higher the current is, the fewer motor rotation speed drop at tracking will be; please increase set value for heavy load tracking occasions.

F04.12: Tracking intensity. Generally, the default is usually adopted. This value may be increased when the tracking speed is high and results in a voltage fault.

Function Code	Name of Function Code	Parameter Description	Unit	Default	Property
F04.14	Acceleration/Deceleration Mode	0: Linear Acceleration/Deceleration 1: S Curve Acceleration/Deceleration		0	○
F04.15	S Curve Start Section Time at Acceleration	0.00 - System acceleration time/2 (F15.13=0) 0.0 - System acceleration time/2 (F15.13=1) 0 - System acceleration time/2 (F15.13=2)	s	1.00	●
F04.16	S Curve End Section Time at Acceleration	0.00 - System acceleration time/2 (F15.13=0) 0.0 - System acceleration time/2 (F15.13=1) 0 - System acceleration time/2 (F15.13=2)	s	1.00	●
F04.17	S Curve Start Section Time at Deceleration	0.00 - System deceleration time/2 (F15.13=0) 0.0 - System deceleration time/2 (F15.13=1) 0 - System deceleration time/2 (F15.13=2)	s	1.00	●
F04.18	S Curve End Section Time at Deceleration	0.00 - System deceleration time/2 (F15.13=0) 0.0 - System deceleration time/2 (F15.13=1) 0 - System deceleration time/2	s	1.00	●

Function Code	Name of Function Code	Parameter Description	Unit	Default	Property
		(F15.13=2)			

F04.14=0: Linear Acceleration/Deceleration

Output frequency increases or decreases in a straight line progressively and default acceleration/deceleration time is set through function codes F00.14 and F00.15.

F04.14=1: S curve acceleration/deceleration

During acceleration in Figure 7-17: t1 is the value set through F04.15 and t2 is the value set through F04.16; during deceleration: t3 is the value set through F04.17 and t4 is the value set through F04.18. During the time period of t1 and t2, and t3 and t4, gradient for output frequency changes is fixed.

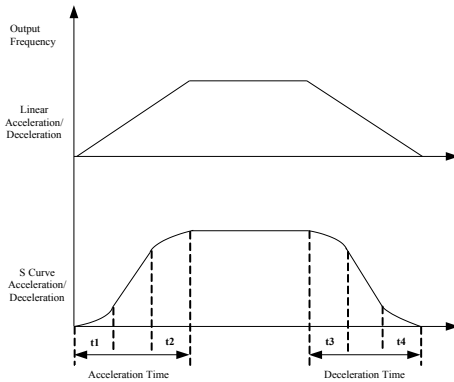

Figure 7-17 Acceleration/Deceleration Time Control

Function Code	Name of Function Code	Parameter Description	Unit	Default	Property
F04.19	Stop Mode	0: Ramp-To-Stop 1: Coast-to-Stop 2: Spindle Orientation Enable When Terminal for Running is Disabled		0	○

F04.19=0: Ramp-To-Stop

Motor ramps to stop after set deceleration time is out [default setting is as per F00.15 (deceleration time 1)]

F04.19=1: Coast-to-Stop

After enabling stop command, inverter will stop output immediately and motor will coast to stop. Specific stop time depends upon the inertia of motor and load.

If the coast-to-stop terminal is set, inverter coasts to stop immediately after the coast-to-stop terminal is enabled; inverter will not run again even if terminal is disabled unless a run command is inputted.

F04.19=1: Spindle Orientation Enable When Terminal for Running is Disabled

Terminal is enabled for starting and stopping, in spindle orientation mode(F30.00=3) if the Terminal is changed from valid to invalid procedure similar to spindle orientation enabled Terminal effective into the spindle orientation features. Stop need keyboard "STOP" key or "free parking" terminals or "external stop Terminal"

Function Code	Name of Function Code	Parameter Description	Unit	Default	Property
F04.20	DC Brake Start Frequency at Stop	0.00 - Maximum Frequency F00.16	Hz	0.00	○
F04.21	DC Brake Current at Stop	0.0 - 150.0 (100.0= Motor Rated Current)	%	100.0	○
F04.22	DC Brake Time at Stop	0.00 - 30.00, Disabled at 0.00	s	0.00	○
F04.23	DC Brake Field Weakening Time at Stop	0.00 - 30.00	s	0.50	○

F04.20 is used to set the frequency of starting DC brake in ramp-to-stop. During ramp-to-stop, once output frequency is lower than this value, inverter will start DC brake if DC brake time at stop is not set as 0.

Different values of F04.21 may realize different DC brake torques at stop.

F04.22 is used to set action time of DC brake at stop. If F04.22=0.00, DC brake at stop will be disabled. If there is also a signal of DC brake from an external terminal, then DC brake time at stop shall be the bigger of the following two: action time of DC brake signal of external terminal, and time set through F04.22.

For 04.23, inverter starts DC brake in ramp-to-stop when output frequency reaches the value set through F04.20 and the time set by F04.24 is reached.

Process of DC brake at stop is shown in Figure 7-19.

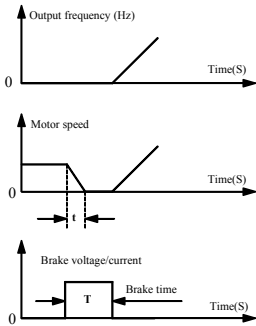

Figure 7-18 Start Process of DC Brake

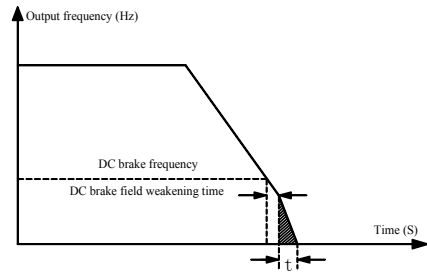

Figure 7-19 Stop Process of DC Brake



Generally, for a heavy load, deceleration operation may not stop motor completely after deceleration time is out due to inertia; extending DC brake time at stop or increasing DC brake current at stop can stop motor.

Function Code	Name of Function Code	Parameter Description	Unit	Default	Property
F04.24	Magnetic Flux Brake Gain	100 – 150 (100: No Magnetic Flux Brake)		100	○

When magnetic flux brake is enabled (F04.24>100), inverter can enable motor for rapid deceleration by the method of increasing magnetic flux of motor. At this time, electric energy in motor brake process can be transformed into thermal energy.

Magnetic flux brake can be used to realize rapid deceleration, but output current may be large, user may set magnetic flux brake intensity (F04.24) for limit protection so as to avoid

damaging motor; if magnetic flux brake is disabled, deceleration time will be long, but output current is small.

Function Code	Name of Function Code	Parameter Description	Unit	Default	Property
F04.26	Start Mode after Fault/Coast to Stop	0: Start as per the Set Mode of F04.00 1: Rotation Speed Tracking Start		0	○

As for start mode after fault or coast to stop, the default is the start as per setting of F04.00 (F04.26=0), but user may select torque tracking start (F04.26=1) in a fixed way. For various stop modes, see function code F04.00.

Function Code	Name of Function Code	Parameter Description	Unit	Default	Property
F04.27	Terminal Start Command Reconfirmation	0: Not to Confirm 1: Confirm		0	○

F04.27=0: Not to Confirm

If running terminal (RUN or F/R) is on and F00.03 is set as 0 or 1, inverter is powered on while enabling or disabling terminal, or inverter runs directly while start/stop mode is switched to terminal.

F04.27=1: Confirm

Close running terminal, set F00.03 as 0 or 1, inverter cannot run directly when start or stop by terminal at power-on or when the starting or stop mode is switched to terminal mode.

Function Code	Name of Function Code	Parameter Description	Unit	Default	Property
F04.29	Zero Frequency	0.00 - 5.00	Hz	0.25	●

When the output frequency is below zero speed frequency, "zero speed" Terminal effective.

Function Code	Name of Function Code	Parameter Description	Unit	Default	Property
F04.30	Initial Position Search after Power-on or Fault	0: Disabled 1: Enabled		0	●

If zero servo function is enabled when output frequency is lower than zero servo start frequency, inverter will enter zero servo running mode.

Function Code	Name of Function Code	Parameter Description	Unit	Default	Property
F04.30	Initial Position Search after Power-on or Fault	0: Disabled 1: Enabled		1	●

When present motor is a synchronous motor (eg: F01.00=2) and in VF control, initial angle is crucial to the control performance; especially, motor may reverse at the moment of start. Therefore, default of inverter is to perform initial position search after power-on or fault, so as to obtain better control performance.

7.6 F05 Group: VF Control Parameter

This group of function codes is only valid for V/F control and not valid for vector control. V/F control applies to general loads like fan and water pump, or to the occasion “one inverter shared by multiple motors” or the occasion where there is high difference between inverter power and motor power.

Function Code	Name of Function Code	Parameter Description	Unit	Default	Property
F05.00	V/F Curve Setting	0: Straight V/F 1: Multi-Dot Polyline V/F 2: VF to the 1.3 rd 3: VF to the 1.7 th 4: Square V/F 5: VF Complete Split Mode (Ud=0, Uq=K*t=Split voltage source voltage) 6: VF Half-Split Mode (Ud=0, Uq=K*t=F/Fe*2*Split voltage source voltage)		0	○

F05.00=0: Straight Line V/F

Applies to general constant torque load

F05.00=1: Multi-Pot V/F

By setting parameters of F05.01 - F05.06, user may obtain a user-defined V/F curve.

F05.00=2/3: VF to the 1.3rd / VF to the 1.7th

Refers to VF curve that goes between linear VF and square VF.

F05.00=4: Square V/F

Applies to centrifugal loads like fan and water pump.

F05.00=5: VF Complete Split Mode

Inverter output frequency and output voltage are independent, with output frequency determined by frequency source and output voltage determined by F05.07 (Voltage Source of VF Separation Mode).

This mode is generally used for occasions such as induction heating, inversion power supply and torque motor control.

F05.00=6: VF Complete Split Mode

In this mode, V and F are proportional. However, the proportion can be set through power supply source (F05.07) and this proportion has something to do with motor rated voltage and rated frequency of F1 group.

Assuming that power supply source is X (0 - 100%), the relationship between output voltage V and frequency F is as follows:

$$V/F=2*X*(\text{motor rated voltage}) / (\text{motor rated frequency})$$

Function Code	Name of Function Code	Parameter Description	Unit	Default	Property
F05.11	V/F Slip Compensation Gain	0.00 - 200.00	%	100.00	●
F05.12	V/F Slip Filter Time	0.00 - 10.00	s	1.00	●

When speed of motor rotor decreases as load increases, user may enable slip compensation so as to ensure that rotor speed is close to synchronous speed under a condition that motor

is under rated load. If motor speed goes below the target value, increase the value set through F05.11.

When rotor speed drops by an increase of load, to ensure rotor speed is close to synchronous speed under rated load, slip compensation can be applied, increase setting value of F05.11.

★ If F05.11=0, slip compensation is disabled; this parameter is only enabled for synchronous motor.

When inverter makes a quick start under large inertia, the slip is 100%; after reaching set frequency, the slip is 0; quick decrease of output frequency would result in overvoltage or overcurrent. F05.02 may mitigate the boost of voltage and current.

Function Code	Name of Function Code	Parameter Description	Unit	Default	Property
F05.01	Multipoint VF Frequency Point F1	0.00 - F05.03	Hz	0.50	●
F05.02	Multipoint VF Voltage Point V1	0.0 - 100.0 (100.0= Rated Voltage)	%	1.0	●
F05.03	Multipoint VF Frequency Point F2	F05.01 - F05.05	Hz	2.00	●
F05.04	Multipoint VF Voltage Point V2	0.0 - 100.0	%	4.0	●
F05.05	Multipoint VF Frequency Point F3	F05.03 - Motor Rated Frequency (Reference Frequency)	Hz	5.00	●
F05.06	Multipoint VF Voltage Point V3	0.0 - 100.0	%	10.0	●

Parameters of function codes F05.05 - F05.10 will be enabled if Multi-Dot Polyline V/F is selected (F05.00=1).

A user-defined V/F curve is determined by the curve set with input frequency percentage and output voltage percentage, and it is linearized at different segments in different input ranges.

Motor rated frequency is the ultimate frequency reached by V/F curve and also the frequency at maximum voltage output. Input frequency percentage: if motor rated frequency is the input frequency, the percentage is 100.0%; output voltage percentage: if motor rated voltage is output voltage (U_e), the percentage is 100.0%.

 The relationship between the three voltage points and the frequency point must meet the following requirements: $V1 < V2 < V3$, $F1 < F2 < F3$.
An excessive slope of V/F curve may result in an “overcurrent” fault. Especially, an excessively high voltage at low frequency may cause motor to be overheated or burn motor and inverter may get in overcurrent stall or overcurrent protection.

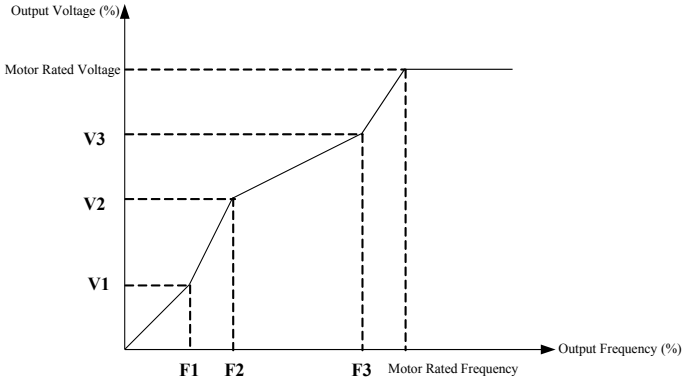

Figure 7-20 Multi-Dot Polyline V/F Curve

Function Code	Name of Function Code	Parameter Description	Unit	Default	Property
F05.07	Voltage Source of VF Separation Mode	0: Numeric Setting of VF Separation Voltage 1: AI1 2: AI2 3: AI3 4: High-Frequency Pulse (X7) 5: PID 6: Communication Setting Note: Motor Rated Voltage is 100%.		0	○
F05.08	Numeric Setting of VF Separation Voltage	0.0 - 100.0 (100.0=Motor Rated Voltage)	%	0.0	●

VF separation is generally used for occasions such as induction heating, inversion power supply and torque motor control.

In VF separation control, output frequency can be set by F05.08 as well as analog quantity, high speed pulse, PID or communication setting. In nonnumeric setting, 100% of each setting refers to motor’s rated voltage. When set percentage of analog output is negative, then take set absolute value as effective value.

F05.07=0: Numeric Setting of VF Separation Voltage (F05.08)

VF separation output voltage is determined by the numeric setting of VF separation voltage (F05.08).

F05.07=1: AI1

F05.07=2: AI2

F05.07=3: AI3

F05.07=4: High-Frequency Pulse Input (X7)

VF separation output voltage is determined by AI/HDI (percentage) * Numeric Setting of VF Separation Voltage (F05.08).

Please refer to the description of F00.04 for detailed explanations of AI1-AI3 and X7.

F00.04 has the same meanings as AI1-AI3 and X7. 100.00% is the percentage inputted through F05.08 (Numeric Setting of VF Separation Voltage).

F05.07=5: Process PID

VF separation output voltage is determined by process PID (see 7.10).

F05.07=6: Communication Setting

VF separation output voltage is determined through communication.

- If inverter is under master-slave communication control (F10.05=1) and present inverter is a slave (F10.06=0), VF separation output voltage is set as “700FH (master-slave communication Setting) * F01.02 (Motor Rated Voltage) * F10.08 (Receiving Proportionality Factor of Slave)”. Range of 700FH is 0.00% to 100.00%. See Table 12-2 for details.
- For general communication (F10.05=0), VF separation output voltage is set as “7006H (VF separation mode voltage setting) * F05.08 (Numeric Setting of VF Separation Voltage)”. Range of 7006H is 0.00% to 100.00%. See Table 12-2 for details.

Function Code	Name of Function Code	Parameter Description	Unit	Default	Property
F05.09	Voltage Rise Time of VF Separation	0.00 - 60.00	s	2.00	●

Voltage rise time of VF separation is the time that the voltage increases from 0 to motor rated voltage.

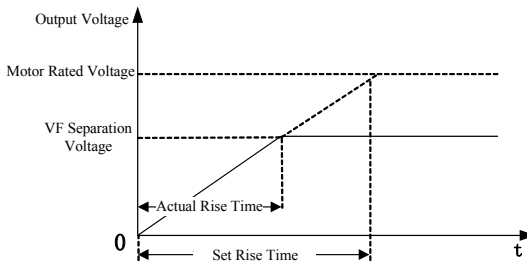

Figure 7-21 Voltage Rise Time of VF Separation

Function Code	Name of Function Code	Parameter Description	Unit	Default	Property
F05.10	Compensation Gain for V/F Stator Voltage Drop	0.00 - 200.00	%	100.00	●

This function code is used to compensate for the voltage drop generated by rotor resistor and cable, and promote loading capacity at low frequency of inverter.

Function Code	Name of Function Code	Parameter Description	Unit	Default	Property
F05.11	V/F Slip Compensation Gain	0.00 - 200.00	%	100.00	●
F05.12	V/F Slip Filter Time	0.00 - 10.00	s	1.00	●

Motor rotor speed decreases as the load increases, in order to ensure the motor under rated load, the rotor speed near synchronous speed, to enable slip compensation. When the motor speed is below target, to increase F05.11 set value;

F05.11=0 V/F Slip Compensation is invalid. The parameter is only valid for asynchronous motor

Function Code	Name of Function Code	Parameter Description	Unit	Default	Property
F05.13	Oscillation Suppression Gain	0 - 20000		100	●
F05.14	Oscillation Suppression End Frequency	0.00 - 600.00	Hz	55.00	●

In VVF, adjusting this parameter can suppress motor oscillation. However, do not adjust it or adjust this parameter to a smaller value properly if there is no motor oscillation; in case of apparent oscillation, adjust this parameter to a bigger parameter properly.

Function Code	Name of Function Code	Parameter Description	Unit	Default	Property
F05.15	Sagging Control Frequency	0.00 - 10.00	Hz	0.00	●

This function is usually applied to load distribution when multiple motors bear one load. Inverter output frequency goes down as load increases; when multiple motors bear the same load, motor output frequency for load will decrease more, thus reducing load of motor and realizing the even load of multiple motors.

This parameter refers to the decline of output frequency when inverter is in rated load output.

Function Code	Name of Function Code	Parameter Description	Unit	Default	Property
F05.16	Energy Saving Rate	0.00 - 50.00	%	0.00	●
F05.17	Energy Saving Actuation Time	1.00 - 60.00	s	5.00	●

Energy saving rate (F05.16) indicates energy saving capacity. The higher set value is, the better energy saving effect will be. If it is set as 0.00, energy saving is disabled.

When energy saving running is enabled, energy saving applications are reached and energy saving actuation time (F05.17) is maintained, then energy saving control will start.

These are optimized parameters for VF control of synchronous motor. Generally, user adopts the defaults.

Function Code	Name of Function Code	Parameter Description	Unit	Default	Property
F05.18	Compensation Gain of Magnetic Flux of Synchronous Motor	0.00 - 500.00	%	100.00	●
F05.19	Filter Time Constant of Magnetic Flux Compensation of Synchronous Motor	0.00 - 10.00	s	0.50	●

7.7 F06 Group: Vector Control Parameter

Function Code	Name of Function Code	Parameter Description	Unit	Default	Property
F06.00	Speed Proportional Gain ASR_P1	0.00 - 100.00		12.00	●
F06.01	Speed Integral Time Constant ASR_T1	0.000 - 30.000 0.000: No Integral	s	0.200	●
F06.02	Speed Proportional	0.00 - 100.00		8.00	●

Function Code	Name of Function Code	Parameter Description	Unit	Default	Property
	Gain ASR_P2				
F06.03	Speed Integral Time Constant ASR_T2	0.000 - 30.000 0.000: No Integral	s	0.300	●
F06.04	Switching Frequency 1	0.00 - Switching Frequency 2	Hz	5.00	●
F06.05	Switching Frequency 2	Switching Frequency 1 - Maximum Frequency F00.16	Hz	10.00	●

Under vector control mode, inverter adjusts speed dynamic response of vector control by adjusting PI regulator's speed proportional gain (ASR_P) and speed integral time (ASR_T). Either increasing ASR_P or reducing ASR_T would quicken velocity loop's dynamic response. However, if ASR_P is excessive or ASR_T is insufficient or excessive, this will result in oscillation due to over regulation.

User shall adjust the aforesaid PI parameters according to actual load characteristics. Generally, user shall increase ASR_P as possible and regulate ASR_T, so as to enable the system to response quickly without over control.

To enable the system to have a quick dynamic response at both low speed and high speed, it's required to perform PI regulation at both speed modes. In actual running, speed regulator would automatically calculate present PI parameter according to present frequency. If present PI parameter is below switching frequency 1, speed PI parameter is P1, T1; if above switching frequency 2, speed parameter PI is P2, T2. If greater than switching frequency 1 (F06.04), but less than switching frequency 2 (F06.05), the movement from switching frequency 1 to switching frequency 2 presents a linear transition procedure. See Figure 7-22.

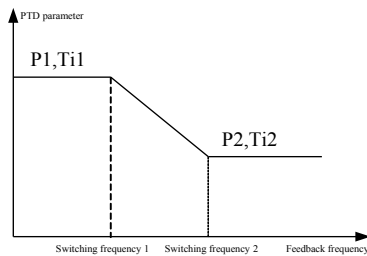

Figure 7-22 PI Parameter



- Generally, user does not need to adjust F06.00 - F06.05 parameters, so please pay enough attention when you decide to adjust these parameters.
- While setting switching frequency, please note that switching frequency 1 (F06.04) must be lower than or equivalent to switching frequency 2 (F06.05).

Function Code	Name of Function Code	Parameter Description	Unit	Default	Property
F06.06	Velocity Loop Anti-Saturation Factor	0.000 - 1.000		0.500	●

When there is overshoot with the speed, properly increase this parameter, if there is no overshoot, try to reduce this parameter and keep the factory setting.

Function Code	Name of Function Code	Parameter Description	Unit	Default	Property
F06.07	Time Constant of Output Filter of Velocity Loop	0.000 - 0.100	s	0.001	●

The velocity loop output filter can reduce the impacts upon current loop, but better not to set a large value for F06.07, which may cause slow response. Generally, user may use the defaults.

Function Code	Name of Function Code	Parameter Description	Unit	Default	Property
F06.08	Vector Control Slip Gain	10.00 - 200.00	%	100.00	●

If motor speed goes below the target value, increase the value set through F06.08.

When inverter is in sensor vector control mode, this parameter is used to adjust speed stability accuracy of motor: if the accuracy is relatively lower, increase the value set by the parameter and vice versa.

When inverter is in FVC control, this parameter can adjust output current of inverter under the same load.

Function Code	Name of Function Code	Parameter Description	Unit	Default	Property
F06.09	Speed Control Torque Limit Source Selection	0: F06.10 and F06.11 1: AI1 2: AI2 3: AI3 4: AI4 (Expansion Card) 5: Communication (Percentage) 6: Maximum of AI2 and AI3 7: Minimum of AI2 and AI3		0	○
F06.10	Upper Limit of JOG for Speed Control	0.0 - 250.0	%	165.0	●
F06.11	Upper Limit of Brake Torque for Speed Control	0.0 - 250.0	%	165.0	●

This function code is used to set the action condition of torque limit during vector control. If inverter output torque is higher than the torque limit, torque limit function is enabled, so as to control output torque to be not higher than upper limit of speed control torque.

F06.09=0: F06.10 is Electric Torque (JOG). F06.11 is Brake Torque.

F06.09=1/2/3/4: torque limit is AI (percentage) * F06.10/F06.11

F06.09=5: torque limit is set by communication (Percentage).

For mater-slave communication (F10.05=1) and the inverter is slave (F10.06=0) the torque limit is 700FH (communication setting) * 250% * F10.08 (gain). The range of 700FH is 0.00% to 100.00%. See Table 12-2 for details.

For general communication (F10.05=0) the torque limit is 7019H * F06.10/F06.11. The range of 7019H is 0.0 to 250%. See Table 12-2 for details.

F06.09=6: Maximum of AI2 and AI3 (percentage)* F06.10/F06.11

F06.09=7: Minimum of AI2 and AI3 (percentage)* F06.10/F06.11

	<ol style="list-style-type: none"> 1. This code indicates the ratio between output torque at torque limit and inverter rated output torque. 2. User can set upper limit of torque as per actual demands to protect motor or meet the operating mode requirements. 3. The jog mode and the brake mode shall be set separately.
---	--

Function Code	Name of Function Code	Parameter Description	Unit	Default	Property
F06.12	Excitation Current Proportional Gain ACR-P1	0.00 - 100.00		0.50	●
F06.13	Excitation Current Integral Time Constant ACR-T1	0.00 - 600.00 0.00: No Integral	ms	10.00	●
F06.14	Torque Current Proportional Gain ACR-P2	0.00 - 100.00		0.50	●
F06.15	Torque Current Integral Time Constant ACR-T2	0.00 - 600.00 0.00: No Integral	ms	10.00	●

Parameters of Current loop PID adjuster would directly impact the performance and stability of the system. On general applications, user does not need to change these

Function Code	Name of Function Code	Parameter Description	Unit	Default	Property
F06.17	SVC Zero Frequency Processing Method	0: Brake 1: Normal 2: No Output		2	○
F06.18	SVC Zero Frequency Band-Type Brake Current	50.0 - 400.0 (100.0=Idling Current)	%	100.0	○

When inverter is at the zero frequency running stage in SVC control mode (eg: F00.01=1), inverter acts as per setting of F06.17.

If F06.17=0, inverter performs the band-type brake as pe rset current of F06.18 to realize zero servo function.

F06.17=1, Not to Process.

F06.17=2, inverter will be blocked for output and coast to stop.

Function Code	Name of Function Code	Parameter Description	Unit	Default	Property
F06.20	Voltage Feedforward Gain	0 - 100	%	0	●

When inverter is in the vector control, add the voltage feedforward gain to realize the automatic torque boost, i.e., stator voltage drop compensation.

Function Code	Name of Function Code	Parameter Description	Unit	Default	Property
F06.21	Field Weakening Control Options	0: Disabled 1: Direct Calculation 2: Automatic Adjustment		2	○
F06.22	Field Weakening Voltage	70.00 - 200.00	%	95.00	●
F06.23	Maximum Field Weakening Current of Synchronous Motor	0.0 - 150.0 (100.0= Motor Rated Current)	%	50.0	●
F06.24	Proportional Gain of Field Weakening Regulator	0.00 - 10.00		0.50	●
F06.25	Integral Time of Field Weakening Regulator	0.01 - 60.00	s	2.00	●

Field Weakening Control Options of Synchronous Motor are described below.

F06.21=0: Disabled

If F06.21=0, field weakening control will not work. At this time, maximum value of motor rotation speed is related to bus voltage of inverter. When maximum speed of motor can not meet user requirements, user needs to start field weakening function of synchronous motor for field weakening speed rise.

EM600 offers two field weakening modes: direct calculation mode and automatic adjustment mode.

F06.21=1 Direct Calculation

In direct calculation method, required field weakening current is calculated as per target rotation speed and its size can be also adjusted manually through 06.22. The lower the field weakening current is, the lower the total output current will be, but this may not achieve the required field weakening effect.

F06.21=2: Automatic Adjustment

In automatic adjustment method, inverter will select optimum field weakening current automatically, but this may affect dynamic performance of the system or cause the system to be unstable.

Setting proportional gain (F06.24) and integral time (F06.25) can change the adjustment speed of field weakening current, but fast adjustment of field weakening current can result in instability. Generally, user does not need to make manual modification.

Function Code	Name of Function Code	Parameter Description	Unit	Default	Property
F06.27	Gain of Autotuning at Initial Position	0 - 600	%	80	●

User may adjust autotuning effect by this parameter when inverter is in initial position autotuning. The value of this parameter is usually got by autotuning and user does not need to set it manually. The higher the injection voltage is, the better autotuning effect will be.

Function Code	Name of Function Code	Parameter Description	Unit	Default	Property
F06.28	Injection Current at Frequency of Low Frequency Range	0.00 - 100.00 (100.00= Motor Rated Frequency)	%	10.00	●
F06.29	Injection Current at Low Frequency Range	0.0 - 60.0 (100.0= Motor Rated Current)	%	20.0	●
F06.30	Low Frequency Range Regulator Gain of Injection Current	0.00 - 10.00		0.50	●
F06.31	Integral Time of Low Frequency Range Regulator of Injection Current	0.00 - 300.00	ms	10.00	●
F06.32	Injection Current at Frequency of High Frequency Range	0.00 - 100.00 (100.00= Motor Rated Frequency)	%	20.00	●
F06.33	Injection Current at High Frequency Range	0.0 - 30.0 (100.0= Motor Rated Current)	%	8.0	●
F06.34	High Frequency Range Regulator Gain of Injection Current	0.00 - 10.00		0.50	●
F06.35	Integral Time of High Frequency Range Regulator of Injection Current	0.00 - 300.00	ms	10.00	●

High frequency current injection method realizes detection of initial position of rotor. When inverter is in stationary status, inject high frequency current to motor stator winding so as to estimate motor rotor position accurately by taking advantage of saliency effect and magnetic flux saturation characteristics and detecting the time of high frequency current peak. According to experimental result, this method does not have a high accuracy or depend upon any motor parameter.

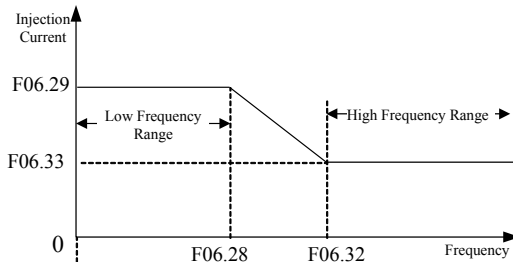

Figure 7-23 High Frequency Injection

At low frequency range (output frequency < F06.28), injection current is determined by F06.29; at high frequency range (output frequency > F06.32), injection current is determined through F06.33.

User may adjust gain and integral time with regulator to achieve better effect. Generally, user may use the default value. Please do not adjust it if you are not a professional.

7.8 F07 Group: Fault Protection Parameter

Function Code	Name of Function Code	Parameter Description							Unit	Default	Property
F07.00	Protection Shield	-	<i>E22</i>	<i>E13</i>	<i>SLU</i>	<i>SOU</i>	<i>SOC</i>	<i>ILP</i>		000 00000	○
		0: Valid Protection 1: Protection Shielded									

Bit setting value=0: After detecting fault corresponding to the bit, inverter will stop output and enter fault status.

Bit setting value=1: After detecting fault corresponding to the bit, inverter will not enable protection and remains the previous status.

This code is bit operation. Only corresponding bit has to be set as 0 or 1. See the table below.

Figure 7-8 Fault Protection Shielding Bit

Protection Code	<i>E22</i>	<i>E13</i>	<i>SLU</i>	<i>SOU</i>	<i>SOC</i>	<i>ILP</i>	<i>OLP</i>
Corresponding Bit	6	5	4	3	2	1	0
Set Value	0/1	0/1	0/1	0/1	0/1	0/1	0/1

For instance: for shielded *ILP* protection, only the first bit corresponding to *ILP* needs to be set as 1, i.e., F07.00=00000010.

To shield *OLP* and *E13*, set bit 0 of *OLP* and bit 5 of *E13* to 1, Namely, F07.00=xx1 xxxx1.



Please do not shield any protection function unless specially required. Otherwise, inverter may be damaged due to no protection in case of a fault.

Function Code	Name of Function Code	Parameter Description	Unit	Default	Property
F07.01	Motor Overload Protection Gain	0.20 - 10.00		1.00	●
F07.02	Motor Overload Pre-Alarming Factor	50 - 100	%	80	●

Inverse-time curve for motor overload protection: $200\% \times (F07.01) \times \text{Motor Rated Current}$, for 1 seconds continuously, an alarm is given for motor overload fault (*E13*);

$150\% \times (F07.01) \times \text{Motor Rated Current}$, for 15 minutes continuously, an alarm is given for motor overload. User must set F07.01 according to motor's actual overload capacity.

Excessive F07.01 value can easily pose a hazard of motor overheating without an alarm.

F07.02 pre-alarm factor is used to determine what degree prior to motor overload protection will trigger an alarm. The higher this factor is, the smaller the advance time of the pre-alarm will be.

If the accumulative output current of inverter is greater than the product of the overload inverse-time curve and F07.02, the multi-function numeric Do of inverter outputs “17: motor overload pre-alarm” ON signal.

Function Code	Name of Function Code	Parameter Description	Unit	Default	Property
F07.03	Motor Temperature Sensor Type	0: No Temperature Sensor 1: PT100 2: PT1000		0	●
F07.04	Motor Overheating Protection Threshold	0 - 200	°C	110	●
F07.05	Motor Overheating Pre-Alarming Threshold	0 - 200	°C	90	●

Default inverter is “no motor temperature protection”. To enable this protection, please confirm that present motor has a temperature sensor and transmits the temperature signal to analog input terminal 4 (AI4, equipped with our IO card EC-IO-A1), and set temperature sensor type (F07.03) to start motor overheating protection.

User can view present motor temperature through function code F18.38; if motor temperature is greater than motor overheating pre-alarm threshold (F07.05), numeric output terminal “25: Motor Overload Pre-alarming” is enabled and this signal is used for instruction; if motor temperature is greater than motor overheating protection threshold (F07.04), inverter will give an alarm about motor overheating fault (E i2) and start corresponding protection action.

★ Motor overheating fault (E i2) can not be reset immediately until motor temperature drops to a value far below the protection threshold.

Function Code	Name of Function Code	Parameter Description	Unit	Default	Property
F07.06	Bus Voltage Control Options	0: Disabled 1: Undervoltage Stall, Enabled 2: Overvoltage Stall, Enabled 3: Overvoltage Stall and Undervoltage Stall, Enabled		2	○
F07.07	Overvoltage Stall Control Voltage	110.0 - 150.0 (380V, 100.0=537V)	%	128.5	●
F07.08	Undervoltage Stall Control Voltage	60.0 - Judgment Operation Voltage at Power Failure Ending (100.0= Standard Bus Voltage)	%	76.0	●

F07.06=0: Disabled

Overvoltage stall disabled; it's not recommended to set F07.06 as 0, if there is no external braking unit.

Undervoltage stall disabled;

F07.06=1: Undervoltage Stall, Enabled

When bus voltage is lower than the value set through F07.08, inverter stops after decelerating to zero, and gives an alarm for stable undervoltage fault (SIU).

F07.06=2: Overvoltage Stall, Enabled

If overvoltage stall is enabled, stall voltage is set by F07.07.

DC bus overvoltage is generally caused by deceleration, because at the time of deceleration, DC bus voltage rises due to energy feedback. When the DC bus voltage is higher than the overvoltage threshold:

If the overvoltage stall is enabled (F07.06=2/3) when the DC bus voltage is higher than the overvoltage threshold, inverter stops the deceleration and keeps output frequency unchanged; as a result, energy feedback stops; until DC busbar voltage backs to normal, inverter starts deceleration again. During deceleration, overvoltage stall protection process is shown in Figure 7-24.

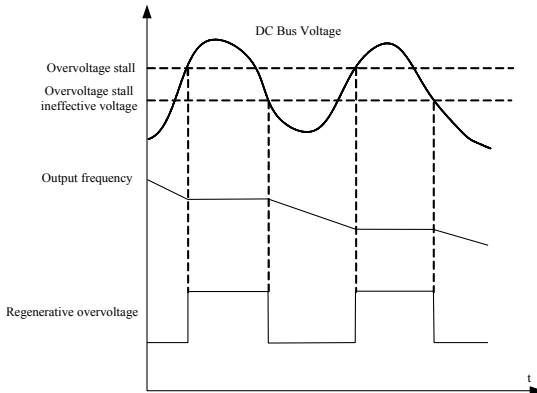

Figure 7-24 Overvoltage Stall Protection

F07.06=3: Overvoltage Stall and Undervoltage Stall, Enabled

Inverter is protected for both overvoltage stall and undervoltage stall.

Function Code	Name of Function Code	Parameter Description	Unit	Default	Property
F07.09	Judgment Operation Voltage at Power Failure Ending	Undervoltage Stall Control Voltage - 100.0	%	86.0	●
F07.10	Judgment Delay Time at Power Failure Ending	0.00 - 100.00	s	5.00	●

If bus voltage is lower than the value set through F07.08 (Undervoltage Stall Control Voltage), inverter will enter power failure status. If bus voltage is greater than F07.09 (Judgment Operation Voltage at Power Failure Ending), which lasts for the time set by F07.10 (Judgment Delay Time at Power Failure Ending), then inverter returns to the normal status.

Function Code	Name of Function Code	Parameter Description	Unit	Default	Property
F07.11	Current Limit Control	0: Disabled 1: Limit Mode 1 2: Limit Mode 2		2	○
F07.12	Current Limit	20.0 - 180.0 (100.0= Inverter Rated)	%	150.0	●

	Level	Current)			
--	-------	----------	--	--	--

F07.11=0: Disabled

Current limit does not work.

F07.11=1: Limit Mode 1

F07.11=2: Limit Mode 2

During operation, if output current reaches to current limit level F07.12 and current limit control is effective, then the system will automatically start current limit: reducing output frequency to restrain output current from going up, and inverter will quit from over current state.

Inverter will return to previous running status, when output current reduces to a value below current limit action level. Current limit action procedure is shown in Figure 7-25.

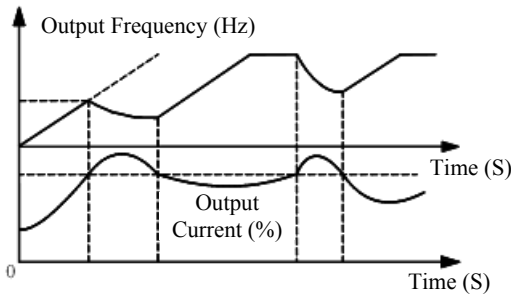



Figure 7-25 Current Limit Action Procedure

F07.12 is used to set the action conditions for enabling current limit. If inverter output current exceeds set value of this function code, the current limit function starts to act, so as to control output current at a level not greater than the current limit.



Current limit only works for inverter under V/F control mode. It's recommended to use this function for occasions of large inertia, fan type load, and the occasion “one inverter shared by multiple motors”.

Function Code	Name of Function Code	Parameter Description	Unit	Default	Property
F07.13	Rapid Current Limit	0: Disabled 1: Enabled		0	○

F07.13=0: Disabled

Rapid current limit does not work.

F07.13=1: Enabled

The rapid current limit can reduce the overcurrent fault.

Function Code	Name of Function Code	Parameter Description	Unit	Default	Property
F07.14	Fault Retry Times	0 – 20, 0: Fault Retry Disabled		0	○
F07.15	Numeric Output Action at Fault Retry	0: Disabled 1: Enabled		0	○
F07.16	Fault Retry Interval	0.01 - 30.00	s	0.50	●

F07.17	Recovery Time of Fault Retry Times	0.01 - 30.00					s	10.00	●
F07.18	Fault Retry	<i>ILP</i>	<i>HOU</i>	<i>HOC</i>	<i>SLU</i>	<i>SOU</i>	<i>SDC</i>	**0 00000	○
		0: Permitted 1: Not Permitted							

Fault retry function can be used to prevent the impact of an accident upon normal system operation. It is only valid for some faults listed by F07.18.

When fault retry function is enabled, a fault will cause inverter to start a fault retry, i.e., fault reset. Whether a fault status is outputted by numeric output terminal shall be set through F07.15. If the fault is still detected subsequent to fault retry, continue with the fault retry until set fault retry times (F07.14) are reached; if the fault is still detected after the fault retry times, an alarm will be given correspondingly; if the fault does not occur again in several following retries, the fault retry succeeds and inverter continues to work normally. After fault retry succeeds, fault retry times will be cleared if no fault occurs in the recovery time of fault retry times (F07.17), and fault retry still starts from 0 times when a fault occurs in the future; a fault retry time will be counted based upon last fault retry count, if the fault still occurs in this retry.

Function Code	Name of Function Code	Parameter Description							Unit	Default	Property	
F07.19	Action 1 at Fault	<i>E21</i>	<i>E16</i>	<i>E15</i>	<i>E14</i>	<i>E13</i>	<i>E12</i>	<i>OLP</i>	<i>ILP</i>	000 00000	○	
		0: Coast to Stop 1: Stop as per the Set Stop Mode										
F07.20	Action 2 at Fault	<i>E28</i>	<i>E27</i>	<i>E25</i>	<i>E23</i>						*0000	○
		0: Coast to Stop 1: Stop as per the Set Stop Mode										

These function codes can be used to set inverter action mode when some faults occur. If any of them is set as 0, inverter coasts to stop; if any of them is set as 1, inverter stops as per set stop mode (F04.19).

Such function codes are under bit operation. Set corresponding position as 0 or 1 while setting them. See the table below.

Table 7-9 Action Bit at Fault

F07.19	<i>E21</i>	<i>E16</i>	<i>E15</i>	<i>E14</i>	<i>E13</i>	<i>E12</i>	<i>OLP</i>	<i>ILP</i>
F07.20	*	*	*	*	<i>E28</i>	<i>E27</i>	<i>E25</i>	<i>E23</i>
Corresponding Bit	7	6	5	4	3	2	1	0
Set Value	0/1	0/1	0/1	0/1	0/1	0/1	0/1	0/1

For example, user only needs to set the first bit of *OLP* and the third bit of *E13* as 1, in order to set *OLP* and *E13* as stop as per set stop mode (F04.19) in case of a fault.

Function Code	Name of Function Code	Parameter Description	Unit	Default	Property
F07.21	Offload Protection	0: Disabled 1: Enabled		0	●
F07.22	Offload Detection Level	0.0 - 100.0	%	20.0	●
F07.23	Load Detection Time	0.0 - 60.0	s	1.0	●
F07.24	Offload Protection	0: Coast to Stop		1	○

		1: Stop as per the Set Stop Mode			
--	--	----------------------------------	--	--	--

If output current is lower than offload detection level (F07.22) and this status continues for offload detection time (F07.23) when offload detection protection is enabled (F07.21=1) and inverter is in running mode and not in DC brake, then inverter gives an offload protection fault (E25) report and stops as the offload protection setting (F07.24).

Function Code	Name of Function Code	Parameter Description	Unit	Default	Property
F07.25	Motor Overspeed Detection Level	0.0 - 50.0 (reference frequency is Maximum Frequency F00.16)	%	20.0	●
F07.26	Motor Overspeed Detection Time	0.0 - 60.0, 0.0: cancel motor overspeed protection	s	1.0	●

If F07.26 is set as 0, the overspeed protection is disabled.

If F07.26 is not set as 0, inverter gives an alarm for motor overspeed protection fault (E25) as long as load speed is higher than motor overspeed detection level (F07.25) and this status continues for motor overspeed detection (F07.26).



Motor overspeed detection will be triggered only when inverter is running or in JOG running status in FVC control mode (F00.01=2).

Function Code	Name of Function Code	Parameter Description	Unit	Default	Property
F07.27	AVR	0: Disabled 1: Enabled		1	○

F07.27=0: AVR is disabled.

F07.27=1: AVR is enabled. The output of inverter is stable when there is voltage fluctuation.

Function Code	Name of Function Code	Parameter Description	Unit	Default	Property
F07.28	Stalling Fault Detection Time	0.0 – 6000.0 (0.0 stalling fault is disabled)	s	60.0	○

F07.28=0: stalling fault detect is disabled. F07.28 isn't 0 and the stalling time is more than F07.28 there is fault E20.

7.9 F08 Group: Preset Speed and Simple PLC Parameter

Function Code	Name of Function Code	Parameter Description	Unit	Default	Property
F08.00	Preset Speed 1	0.00 - Maximum Frequency F00.16	Hz	0.00	●
F08.01	Preset Speed 2	0.00 - Maximum Frequency F00.16	Hz	5.00	●

Function Code	Name of Function Code	Parameter Description	Unit	Default	Property
F08.02	Preset Speed 3	0.00 - Maximum Frequency F00.16	Hz	10.00	●
F08.03	Preset Speed 4	0.00 - Maximum Frequency F00.16	Hz	15.00	●
F08.04	Preset Speed 5	0.00 - Maximum Frequency F00.16	Hz	20.00	●
F08.05	Preset Speed 6	0.00 - Maximum Frequency F00.16	Hz	25.00	●
F08.06	Preset Speed 7	0.00 - Maximum Frequency F00.16	Hz	30.00	●
F08.07	Preset Speed 8	0.00 - Maximum Frequency F00.16	Hz	35.00	●
F08.08	Preset Speed 9	0.00 - Maximum Frequency F00.16	Hz	40.00	●
F08.09	Preset Speed 10	0.00 - Maximum Frequency F00.16	Hz	45.00	●
F08.10	Preset Speed 11	0.00 - Maximum Frequency F00.16	Hz	50.00	●
F08.11	Preset Speed 12	0.00 - Maximum Frequency F00.16	Hz	50.00	●
F08.12	Preset Speed 13	0.00 - Maximum Frequency F00.16	Hz	50.00	●
F08.13	Preset Speed 14	0.00 - Maximum Frequency F00.16	Hz	50.00	●
F08.14	Preset Speed 15	0.00 - Maximum Frequency F00.16	Hz	50.00	●

Inverter can offer 16 preset speeds through the control terminal of multiple preset speeds and 15 preset frequency commands, as well as numeric frequency setting F00.07.

Table 7-10 Preset Speed Commands and Preset Speed Terminals

Preset Speed	Preset Speed Terminal 4	Preset Speed Terminal 3	Preset Speed Terminal 2	Preset Speed Terminal 1	Set Frequency	Corresponding Function Code
1	Disabled	Disabled	Disabled	Disabled	Numeric Frequency Setting	Determined through
2	Disabled	Disabled	Disabled	Enabled	Preset Speed 1	F08.00
3	Disabled	Disabled	Enabled	Disabled	Preset Speed 2	F08.01
4	Disabled	Disabled	Enabled	Enabled	Preset Speed 3	F08.02
5	Disabled	Enabled	Disabled	Disabled	Preset Speed 4	F08.03
6	Disabled	Enabled	Disabled	Enabled	Preset Speed 5	F08.04
7	Disabled	Enabled	Enabled	Disabled	Preset Speed 6	F08.05
8	Disabled	Enabled	Enabled	Enabled	Preset Speed 7	F08.06
9	Enabled	Disabled	Disabled	Disabled	Preset Speed 8	F08.07

Preset Speed	Preset Speed Terminal 4	Preset Speed Terminal 3	Preset Speed Terminal 2	Preset Speed Terminal 1	Set Frequency	Corresponding Function Code
10	Enabled	Disabled	Disabled	Enabled	Preset Speed 9	F08.08
11	Enabled	Disabled	Enabled	Disabled	Preset Speed 10	F08.09
12	Enabled	Disabled	Enabled	Enabled	Preset Speed 11	F08.10
13	Enabled	Enabled	Disabled	Disabled	Preset Speed 12	F08.11
14	Enabled	Enabled	Disabled	Enabled	Preset Speed 13	F08.12
15	Enabled	Enabled	Enabled	Disabled	Preset Speed 14	F08.13
16	Enabled	Enabled	Enabled	Enabled	Preset Speed 15	F08.14

Attentions:

- ★ At preset speed running, inverter start/stop is determined by function code F00.02.
- ★ At preset speed running mode, inverter acceleration/deceleration time can be controlled by external terminal set as acceleration/deceleration time.

Direction at preset speed running is controlled by terminals F/R and RUN.

Function Code	Name of Function Code	Parameter Description	Unit	Default	Property
F08.15	Simple PLC Running Mode	0: Stop after Single Running 1: Stop after Limited Times of Cycles 2: Run at Last Preset Speed after Limited Times of Cycles 3: Continuous Cycle		0	●
F08.16	Limited Times of Cycles	1 - 10000		1	●

In addition to preset speed function, inverter also has simple PLC function, which provides four control modes. See Table 7-11 for details.

Table 7-11 PLC Running Mode

F08.15	Description
0	Inverter stops after running at last preset speed.
1	Run circularly; the cycle times is set through F08.16; inverter stops after the cycles are complete.
2	Run circularly; the number of cycle times is set through F08.16; after having completed the running at last preset speed, inverter keeps running at last preset speed until a stop command is received.
3	Run continuously and circularly until a stop command is received.

- ★ Inverter starts judgment from run time of the 15th preset speed (F08.48) to the first preset speed. A function code not set as 0 is last preset speed.

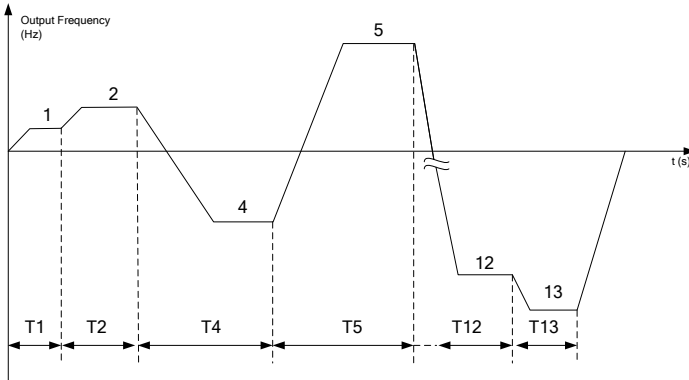

Figure 7-26 Simple PLC Running

As illustrated in Figure 7-26, it is running mode after setting “0: Stop after Single Running”. Since preset speed 3 is set as 0 (F08.24=0.0), inverter will not run at preset speed 3 actually. Since preset speed 14 and preset speed 15 are set as 0 (F08.46=0.0 and F08.48=0.0), preset speed 13 is last one and inverter will stop after running at preset speed 13.

Function Code	Name of Function Code	Parameter Description	Unit	Default	Property
F08.17	Simple PLC Memory	Ones Place: Stop Memory 0: Disabled (Start from the Preset Speed 1) 1: Enabled (Start at Power Failure) Tens Place: Power Failure Memory 0: Disabled (Start from the Preset Speed 1) 1: Enabled (Start at Power Failure)		00	●

PLC stop memory function enables inverter to record running times (F18.10), running stage (F18.11) and present running time (F18.12) of present simple PLC at stop. Inverter continues with the memorized stage for the running of next time. If simple PLC memory function is disabled, PLC process will be started for every time after inverter restart. PLC power failure memory function enables inverter to record running times (F18.10), running stage (F18.11) and present running time (F18.12) of present simple PLC before the power failure. Inverter continues with memorized stage at next energization. If PLC power failure memory function is disabled, PLC process will be started for every time after inverter restart.

Function Code	Name of Function Code	Parameter Description	Unit	Default	Property
F08.18	Simple PLC Time Unit	0: s 1: min		0	●

To meet different applications, setting for running time of PLC can be in figures only. Specific meanings shall be set together with simple PLC time unit (F08.18). There are two time units available.

Function Code	Name of Function Code	Parameter Description	Unit	Default	Property
---------------	-----------------------	-----------------------	------	---------	----------

Function Code	Name of Function Code	Parameter Description	Unit	Default	Property
F08.19	Setting of Preset Speed 1	Ones Place: Running Direction 0: Forward 1: Reverse Tens Place: Acceleration/Deceleration Time 0: Acceleration/Deceleration Time 1 1: Acceleration/Deceleration Time 2 2: Acceleration/Deceleration Time 3 3: Acceleration/Deceleration Time 4		0	●
F08.20	Running Time of Preset Speed 1	0.0 - 6000.0		5.0	●
F08.21	Setting of Preset Speed 2	Ones Place: Running Direction 0: Forward 1: Reverse Tens Place: Acceleration/Deceleration Time 0: Acceleration/Deceleration Time 1 1: Acceleration/Deceleration Time 2 2: Acceleration/Deceleration Time 3 3: Acceleration/Deceleration Time 4		0	●
F08.22	Running Time of Preset Speed 2	0.0 - 6000.0		5.0	●
F08.23	Setting of Preset Speed 3	Ones Place: Running Direction 0: Forward 1: Reverse Tens Place: Acceleration/Deceleration Time 0: Acceleration/Deceleration Time 1 1: Acceleration/Deceleration Time 2 2: Acceleration/Deceleration Time 3 3: Acceleration/Deceleration Time 4		0	●
F08.24	Running Time of Preset Speed 3	0.0 - 6000.0		5.0	●
F08.25	Setting of Preset Speed 4	Ones Place: Running Direction 0: Forward 1: Reverse Tens Place: Acceleration/Deceleration Time 0: Acceleration/Deceleration Time 1 1: Acceleration/Deceleration Time 2 2: Acceleration/Deceleration Time 3 3: Acceleration/Deceleration Time 4		0	●
F08.26	Running Time of Preset Speed 4	0.0 - 6000.0		5.0	●
F08.27	Setting of Preset Speed 5	Ones Place: Running Direction 0: Forward		0	●

Function Code	Name of Function Code	Parameter Description	Unit	Default	Property
		1: Reverse Tens Place: Acceleration/Deceleration Time 0: Acceleration/Deceleration Time 1 1: Acceleration/Deceleration Time 2 2: Acceleration/Deceleration Time 3 3: Acceleration/Deceleration Time 4			
F08.28	Running Time of Preset Speed 5	0.0 - 6000.0		5.0	●
F08.29	Setting of Preset Speed 6	Ones Place: Running Direction 0: Forward 1: Reverse Tens Place: Acceleration/Deceleration Time 0: Acceleration/Deceleration Time 1 1: Acceleration/Deceleration Time 2 2: Acceleration/Deceleration Time 3 3: Acceleration/Deceleration Time 4		0	●
F08.30	Running Time of Preset Speed 6	0.0 - 6000.0		5.0	●
F08.31	Setting of Preset Speed 7	Ones Place: Running Direction 0: Forward 1: Reverse Tens Place: Acceleration/Deceleration Time 0: Acceleration/Deceleration Time 1 1: Acceleration/Deceleration Time 2 2: Acceleration/Deceleration Time 3 3: Acceleration/Deceleration Time 4		0	●
F08.32	Running Time of Preset Speed 7	0.0 - 6000.0		5.0	●
F08.33	Setting of Preset Speed 8	Ones Place: Running Direction 0: Forward 1: Reverse Tens Place: Acceleration/Deceleration Time 0: Acceleration/Deceleration Time 1 1: Acceleration/Deceleration Time 2 2: Acceleration/Deceleration Time 3 3: Acceleration/Deceleration Time 4		0	●
F08.34	Running Time of Preset Speed 8	0.0 - 6000.0		5.0	●
F08.35	Setting of Preset Speed 9	Ones Place: Running Direction 0: Forward 1: Reverse Tens Place:		0	●

Function Code	Name of Function Code	Parameter Description	Unit	Default	Property
		Acceleration/Deceleration Time 0: Acceleration/Deceleration Time 1 1: Acceleration/Deceleration Time 2 2: Acceleration/Deceleration Time 3 3: Acceleration/Deceleration Time 4			
F08.36	Running Time of Preset Speed 9	0.0 - 6000.0		5.0	●
F08.37	Setting of Preset Speed 10	Ones Place: Running Direction 0: Forward 1: Reverse Tens Place: Acceleration/Deceleration Time 0: Acceleration/Deceleration Time 1 1: Acceleration/Deceleration Time 2 2: Acceleration/Deceleration Time 3 3: Acceleration/Deceleration Time 4		0	●
F08.38	Running Time of Preset Speed 10	0.0 - 6000.0		5.0	●
F08.39	Setting of Preset Speed 11	Ones Place: Running Direction 0: Forward 1: Reverse Tens Place: Acceleration/Deceleration Time 0: Acceleration/Deceleration Time 1 1: Acceleration/Deceleration Time 2 2: Acceleration/Deceleration Time 3 3: Acceleration/Deceleration Time 4		0	●
F08.40	Running Time of Preset Speed 11	0.0 - 6000.0		5.0	●
F08.41	Setting of Preset Speed 12	Ones Place: Running Direction 0: Forward 1: Reverse Tens Place: Acceleration/Deceleration Time 0: Acceleration/Deceleration Time 1 1: Acceleration/Deceleration Time 2 2: Acceleration/Deceleration Time 3 3: Acceleration/Deceleration Time 4		0	●
F08.42	Running Time of Preset Speed 12	0.0 - 6000.0		5.0	●
F08.43	Setting of Preset Speed 13	Ones Place: Running Direction 0: Forward 1: Reverse Tens Place: Acceleration/Deceleration Time 0: Acceleration/Deceleration Time 1		0	●

Function Code	Name of Function Code	Parameter Description	Unit	Default	Property
		1: Acceleration/Deceleration Time 2 2: Acceleration/Deceleration Time 3 3: Acceleration/Deceleration Time 4			
F08.44	Running Time of Preset Speed 13	0.0 - 6000.0		5.0	●
F08.45	Setting of Preset Speed 14	Ones Place: Running Direction 0: Forward 1: Reverse Tens Place: Acceleration/Deceleration Time 0: Acceleration/Deceleration Time 1 1: Acceleration/Deceleration Time 2 2: Acceleration/Deceleration Time 3 3: Acceleration/Deceleration Time 4		0	●
F08.46	Running Time of Preset Speed 14	0.0 - 6000.0		5.0	●
F08.47	Setting of Preset Speed 15	Ones Place: Running Direction 0: Forward 1: Reverse Tens Place: Acceleration/Deceleration Time 0: Acceleration/Deceleration Time 1 1: Acceleration/Deceleration Time 2 2: Acceleration/Deceleration Time 3 3: Acceleration/Deceleration Time 4		0	●
F08.48	Running Time of Preset Speed 15	0.0 - 6000.0		5.0	●

In PLC running mode, present speeds 1 – 15 can be used to set the running frequency, running direction, acceleration/deceleration time and running time. In the following part, preset speed 13 (being last preset speed) will be taken as an example. Its running applications are shown in Figure 7-26.

If F08.12=50.00, the running frequency of preset speed 13 is 50.00Hz;

If F08.43=31, running direction controlled by preset speed 13 is reverse, with acceleration/deceleration controlled by acceleration/deceleration time 4 (F15.07/F15.08);

If F08.44=5.0, running time of preset speed 13 is 5.0s (default setting F08.18=0).

7.10 F09 Group: PID Function Parameter

EM600 inverter has a process PID function, which is to be described in this part. The process PID function is mainly used for pressure control, flow control and temperature control.

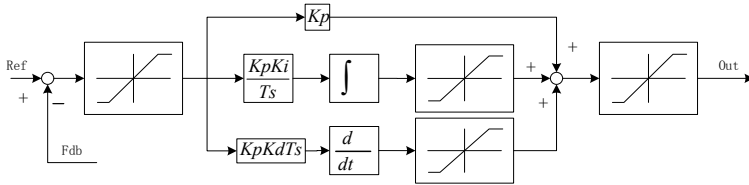

Figure 7-27 Process PID Block Diagram

PID control is a closed loop control mode. Output signal (Out) of controlled object of the system is fed back to PID controller, which adjusts output of controller through PID arithmetic and forms a closed loop or multiple closed loops. By using PID control, output value and set target value of controlled object are consistent. See Figure 7-27 for the functional block diagram.

PID controller implements control by calculating controlled quantity with three calculation factors, i.e., P (proportional), I (integral) and D (differential) and on the basis of dispersion between target (Ref) and feedback signal. Features of various calculation factors are as follows:

P (proportion):

Proportional control is the simplest control mode. Output error signal and input error signal of its control are proportional. The system outputs the stable error when inverter is in proportional control only.

I (integral):

The integrals of output error signal and input error signal of the controller are directly proportional. This control mode can eliminate stable error and enable the system to be free from stable error after entering the stable status. However, under this mode, inverter can not track intense changes.

D (Differential):

The differential values of output error signal and input error signal of the controller are directly proportional. Its controller can predicate the trend of error changes and respond to intense changes to improve the dynamic characteristics of the system in the regulation process.

Function Code	Name of Function Code	Parameter Description	Unit	Default	Property
F09.00	PID Setting Source	0: Numeric PID Setting 1: AI1 2: AI2 3: AI3 4: AI4 (Expansion Card) 5: High-Frequency Pulse (X7) 6: Communication Setting		0	○
F09.01	Numeric PID Setting	0.0 – PID Setting Feedback Range F09.03		0.0	●
F09.03	PID Setting Feedback Range	0.1 - 6000.0		100.0	●

F09.00=0: Numeric PID Setting F09.01

PID setting is done by numeric PID setting, with the specific percentage of F09.01/F09.03 * 100.00%.

F09.00=1: AI1

F09.00=2: AI2**F09.00=3: AI3****F09.00=4: AI4 (Expansion Card)**

The specific percentage of PID setting is directly determined by AI (percentage).

F09.00=5: High-Frequency Pulse (X7)

Specific percentage of PID setting is directly determined by HDI (percentage).

Please refer to the description of F00.04 for detailed explanations of AI1-AI4 and X7.

When they are used for PID setting, their percentages are set values, with maximum output of 100.00%.

F09.00=6: Communication Setting

The specific percentage of PID setting is directly determined by communication (percentage).

- If inverter is under master-slave communication control (F10.05=1) and present inverter is a slave (F10.06=0), set percentage is “700 FH (Master-Slave Communication Setting) * F10.08 (Receiving Proportionality Factor of Slave)”. Range of 700 FH is -100.00% to 100.00%. See Table 12-2 for details.
- For general communication (F10.05=0), set percentage is “7004H (Communication Setting of Process PID)”. Range of 7004H is -100.00% to 100.00%. See Table 12-2 for details.

Function Code	Name of Function Code	Parameter Description	Unit	Default	Property
F09.02	PID Feedback Source	1: AI1 2: AI2 3: AI3 4: AI4 (Expansion Card) 5: High-Frequency Pulse (X7) 6: Communication Setting		1	○

F09.02=1: AI1**F09.02=2: AI2****F09.02=3: AI3****F09.02=4: AI4 (Expansion Card)**

The specific percentage of PID feedback is directly determined by AI (percentage).

F09.02=5: High-Frequency Pulse (X7)

The specific percentage of PID feedback is directly determined by HDI (percentage).

Please refer to the description of F00.04 for detailed explanations of AI1-AI4 and X7.

When they are used for PID setting, their percentages are set values, with maximum output of 100.00%.

F09.02=6: Communication Setting

The specific percentage of PID feedback is directly determined by communication (percentage).

- If inverter is under master-slave communication control (F10.05=1) and present inverter is a slave (F10.06=0), the feedback percentage is “700 FH (Master-Slave Communication Setting) * F10.08 (Receiving Proportionality Factor of Slave)”. Range of 700 FH is -100.00% to 100.00%. See Table 12-2 for details.
- For general communication (F10.05=0), the feedback percentage is “7005 H (Communication Setting of Process PID Feedback)”. Range of 7005 H is -100.00% to 100.00%. See Table 12-2 for details.

Function Code	Name of Function Code	Parameter Description	Unit	Default	Property
F09.04	PID Positive/Negative Reaction	0: Positive Action 1: Negative Action		0	○

The action mode of process PID is determined through setting of F09.04 and the status of input function “PID Positive/Negative Action Switch” together. See Table 7-12 for their relationship details.

Table 7-12 PID Positive/Negative Action

F09.04	PID Positive/Negative Reaction	Action Mode	Description
0	0	Positive Action	Positive offset and output quantity
0	1	Negative Action	Positive offset, but negative output quantity
1	0	Negative Action	Positive offset, but negative output quantity
1	1	Positive Action	Positive offset and output quantity

Note: The offset is usually “Setting - Feedback” in PID control.

- When feedback signal is greater than PID setting, it’s required to drop inverter output frequency to balance PID. An example is given about supply control: when the pressure increases, the pressure feedback increases as well; at this time, only by reducing output frequency of inverter can the pressure go down and stabilize; PID setting shall be in the positive action control.
- When feedback signal is greater than PID setting, it’s required to increase inverter output frequency to balance PID. An example is given about supply control: PID regulator shall be in the negative action control.

Function Code	Name of Function Code	Parameter Description	Unit	Default	Property
F09.05	Proportional Gain 1	0.00 - 100.00		0.40	●
F09.06	Integral Time 1	0.000 - 30.000, 0.000: No Integral	s	10.000	●
F09.07	Differential Time 1	0.000 - 30.000	ms	0.000	●
F09.08	Proportional Gain 2	0.00 - 100.00		0.40	●
F09.09	Integral Time 2	0.000 - 30.000, 0.000: No Integral	s	10.000	●
F09.10	Differential Time 2	0.000 - 30.000	ms	0.000	●
F09.11	PID Parameter Switching	0: Disabled 1: Switching through Numeric Input Terminal 2: Automatic Switching by Offset		0	●
F09.12	PID Parameter Switching Offset 1	0.00 - F09.13	%	20.00	●
F09.13	PID Parameter Switching Offset 2	F09.12 - 100.00	%	80.00	●

To meet different complicated applications, process PID module has introduced two groups of PID parameters. Parameters can be switched between these two groups through the function setting of F09.11 and the input applications (input function “43: PID Parameter

Switching”, offset $e(k)$, etc.) and performed for linear interpolation. See Table 7-13 for details.

Table 7-13 PID Parameter Options

Mode		Description
F09.11	Other Conditions	
0	--	Not Switching of PID Parameter, the first group of parameters work
1	43: PID Parameter Switch	PID parameter is switched by the numeric input terminal (43: PID Parameter Switch)
	0	Invalid switching, the first group of parameters work
	1	Invalid switching, the second group of parameters work
2	$ e(k) - F09.12/13$	2: Automatic Switching by Offset
	$ e(k) < F09.12$	The first group of parameters
	$ e(k) > F09.13$	The first group of parameters
	Intermediate Value	Two groups of parameters are taken as the reference for linear interpolation according to the offset.

As listed in the table above, when function code F09.11 is set as 0, PID parameters will not be switched and the first group of parameters works; when function code is set as 1, PID parameters will be switched according to input function “43: PID Parameter Switching”; when function code is set as 2, PID parameters will be selected or operated by linear interpolation according to the relationship between absolute value of present offset $e(k)$ ($=|Setting - Feedback|$) and function codes F09.12 and F09.13.

When $F09.12 \leq |e(k)| \leq F09.13$, present PID parameter is obtained through the linear interpolation of parameters of the first group and the second group. See 7-28 median section for specific principles.

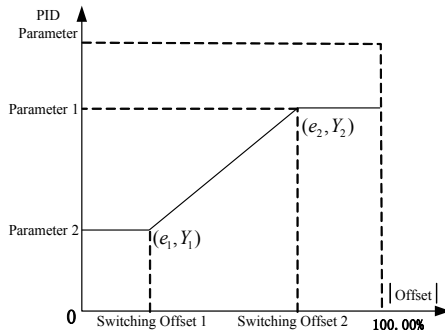

Figure 7-28 Automatic Switching of PID Parameters by Offset (F19.11=2)

Function Code	Name of Function Code	Parameter Description	Unit	Default	Property
F09.14	PID Initial Value	0.00 - 100.00	%	0.00	●
F09.15	PID Initial Value Retention time	0.00 - 650.00	s	0.00	●

The process PID module outputs PID initial value (F09.14) constantly for PID initial value retention time after inverter starts to run; afterwards, inverter proceeds with PID output regulation. See Figure 7-29 for specific effects.

When PID initial value is held for 0.00s, i.e., F09.15=0.00, the output function of PID initial value is disabled.

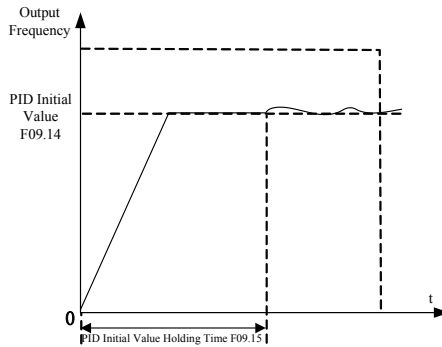

Figure 7-29 PID Initial Value Output

Function Code	Name of Function Code	Parameter Description	Unit	Default	Property
F09.16	Upper Limit of PID Output	F9.17 - +100.0	%	100.0	●
F09.17	Lower Limit of PID Output	-100.0 - F9.16	%	0.0	●

For PID output limit, the output range of the whole process PID module is F09.17 - F09.16, actual regulation results are in this scope, with the output at the boundary.

Function Code	Name of Function Code	Parameter Description	Unit	Default	Property
F09.18	PID Offset Limit	0.00 - 100.00, Disabled at 0.00	%	0.00	●

When the offset between PID setting and feedback is less than and equal to the offset limit (F09.18), PID stops the regulation. In this way, when the offset between setting and the feedback is low, output frequency stabilizes, which works for some closed loop control occasions.



When input terminal function “41: Process PID Stop” is enabled, PID can also stop the regulation. User may use these two methods together.

Function Code	Name of Function Code	Parameter Description	Unit	Default	Property
F09.19	PID Differential Limit	0.00 - 100.00	%	5.00	●

Differential (D) component of PID regulator can not be greater than PID differential limit value (F09.19) to avoid excessively high offset, otherwise the output is also greater and causes the system oscillation. Properly setting this value can affect the impact of occasional interference upon the system.

Function Code	Name of Function Code	Parameter Description	Unit	Default	Property
F09.20	PID Integral Separation Threshold	0.00 - 100.00, (100.00%=Integral Separation Disabled)	%	100.00	●

To perform PID regulation in a faster and better way, it's not required to conduct integral regulation temporarily sometimes, but only PD or P regulation. EM600 inverter has a particular integral separation function: When the offset between PID setting and feedback is

greater than PID integral separation threshold (F09.20), the integral separation is enabled, i.e., integral (I) regulation function of PID regulator stops. Input terminal function “42: Process PID Integral Stop” can be used together for remote control. If function code setting is disabled (F09.20=100.00), input terminal function does not work. See Table 7-14 for details.

Table 7-14 Integral Separation Function Description

Mode		Description
F09.20	DI (42)	F09.20: PID Integral Separation Threshold; DI (42): Process PID Integral Stop
100.00%	--	The integral (I) is always enabled
0.00%		Up to the relationship between $ e(k) $ and F09.20, and the status of DI
-	Disabled	If $ e(k) > F09.20$, the integral separation will be enabled.
99.99%	Enabled	Integral Separation Enabled

Function Code	Name of Function Code	Parameter Description	Unit	Default	Property
F09.21	PID Setting Variation Time	0.000 - 30.000	s	0.000	●

PID setting variation time refers to the time required for the change from 0.0% to 100.0%. It is similar to an acceleration/deceleration function. If PID setting changes, actual setting value of PID will have a linear change to reduce impact incurred upon system. After initial value is set, smooth setting will be invalid.

Function Code	Name of Function Code	Parameter Description	Unit	Default	Property
F09.22	PID Feedback Filter Time	0.000 - 30.000	s	0.000	●
F09.23	PID Output Filter Time	0.000 - 30.000	s	0.000	●

F09.22 is used for filtering of PID feedback quantity. Filtering action is in favor of reducing interference impact upon feedback quantity, but causes response performance of closed loop system of the process to go down.

F09.23 is used for filtering of PID output quantity. Filtering action will weaken sudden change of inverter output frequency, but will also cause the response performance of closed loop system of the process to go down.

Function Code	Name of Function Code	Parameter Description	Unit	Default	Property
F09.24	Upper Limit Detection Value of PID Feedback Disconnection	0.00 - 100.00 100.00.00=Feedback Disconnection Disabled	%	100.00	●
F09.25	Lower Limit Detection Value of PID Feedback Disconnection	0.00 - 100.00 0.00=Feedback Disconnection Disabled	%	0.00	●
F09.26	PID Feedback Disconnection Detection Time	0.000 - 30.000	s	0.000	●

PID feedback disconnection detection function can be used to prevent a slip accident due to the feedback disconnection. The setting depends upon the nature of feedback sensor. If 0.0% sensor is fed back at disconnection, it's required to set F09.25 as a proper value. When feedback quantity is less than the value set through F09.25 and this status is maintained for F09.26, it is deemed as PID feedback disconnection. If 100.0% sensor is fed back at disconnection, it's required to set F09.24 as a proper value. When feedback quantity

is greater than the value set through F09.24 and this status is maintained for F09.26, it is deemed as PID feedback disconnection.

★ Once feedback sensor is determined, only corresponding detection mode is enabled, either upper limit detection or lower limit detection, other than both.

Function Code	Name of Function Code	Parameter Description	Unit	Default	Property
F09.27	PID Sleep Control	0: Disable 1: Zero Speed Enable 2: Lower Limit Frequency Enable 3: No Output Enable		0	●
F09.28	Sleep Action Point	0.00 - 100.00 (100.00 corresponds to PID Setting Feedback Range)	%	100.00	●
F09.29	Sleep Delay Time	0.0 - 6500.0	s	0.0	●
F09.30	Awakening Action Point	0.00 - 100.00 (100.00 corresponds to PID Setting Feedback Range)	%	0.00	●
F09.31	Awakening Delay Time	0.0 - 6500.0	S	0.0	●

At a moment in some occasions, when both output quantity and feedback quantity stabilize or controlled quantity is in permitted range, output is not permitted at this time and inverter can enter into transient sleep status; when controlled quantity exceeds permitted range, inverter is awakened and starts output again; in this way, these function codes not only control controlled quantity within permitted quantity and saves energy. See Table 7-15 for detailed function description.

Table 7-15 Sleep Awakening Function

Mode		Description
Action Mode	Status	
Positive Action (Constant Voltage Control)	Normal Operation	Judge sleep condition: If absolute value of feedback > sleep action point (F09.28) or inverter output frequency reaches the lower limit and cannot continue to decelerate (inverter lower limit frequency or PID output lower limit) and this status is maintained for sleep delay time (F09.29), inverter enters into sleep mode. ★ During delay, PID continues the output; after delay, PID outputs 0.
	Sleep Mode	Judge awakening condition: If absolute value of feedback ≤ awakening action point (F09.28) and this status is maintained for awakening delay time (F09.31), inverter exits sleep mode. ★ During delay, PID outputs 0; after delay, PID continues with the normal output.
Negative Action (Constant Temperature Control)	Normal Operation	Judge sleep condition: If absolute value of feedback < sleep action point (F09.28) or inverter output frequency reaches the lower limit and cannot continue to decelerate (inverter lower limit frequency or PID output lower limit) and this status is maintained for sleep delay time (F09.29), inverter enters into sleep mode. ★ During delay, PID continues the output; after delay, PID

Mode		Description
Action Mode	Status	
		outputs 0.
	Sleep Mode	Judge awakening condition: If absolute value of feedback \geq awakening action point (F09.28) and this status is maintained for awakening delay time (F09.31), inverter exits sleep mode. ★ During delay, PID outputs 0; after delay, PID continues with normal output.

Recommendation: during positive action, F09.28 (awakening action point) \geq F09.30 (awakening action point); during negative action, F09.28 (awakening action point) \leq F09.30 (awakening action point).

Function Code	Name of Function Code	Parameter Description	Unit	Default	Property
F09.32	Preset PID Setting 1	0.0 – PID Setting Feedback Range F09.03		0.0	●
F09.33	Preset PID Setting 2	0.0 – PID Setting Feedback Range F09.03		0.0	●
F09.34	Preset PID Setting 3	0.0 – PID Setting Feedback Range F09.03		0.0	●

These function codes are used for PID setting together with function code F09.00. EM600 inverter has preset PID setting function, for which switching condition is mainly determined by input function “15: Preset PID Terminal 1” and “16: Preset PID Terminal 2”. See Table 7-16 for details.

Table 7-16 Preset PID Setting Function

Mode			Setting	Range	PID Setting
16	15	F09.00			
Disabled	Disabled	0	F09.01	0.0 - F09.03	0.00% - 100.00%
		1	AI1	-100.00% - 100.00%	-100.00% - 100.00%
		2	AI2	-100.00% - 100.00%	-100.00% - 100.00%
		3	AI3	-100.00% - 100.00%	-100.00% - 100.00%
		4	AI4	-100.00% - 100.00%	-100.00% - 100.00%
		5	HDI	-100.00% - 100.00%	-100.00% - 100.00%
6	485	-100.00% - 100.00%	-100.00% - 100.00%	-100.00% - 100.00%	
Disabled	Enabled	--	F09.32	0.0 - F09.03	0.00% - 100.00%
Enabled	Disabled	--	F09.33	0.0 - F09.03	0.00% - 100.00%
Enabled	Enabled	--	F09.34	0.0 - F09.03	0.00% - 100.00%

7.11 F10 Group: Communication Function Parameter

EM 600 inverter supports Modbus protocol of RTU format and the single-master and multi-slave communication network with RS485 bus (see 11.5).

Function Code	Name of Function Code	Parameter Description	Unit	Default	Property
F10.00	Inverter Address	1 - 247, 0 as broadcasting address		1	○

As a slave when connected to the whole communication network, inverter must have a unique address, for which setting scope is 1 to 247. That is to say, 247 inverters are supported by one network.

★ 0 is a broadcasting address, which can be recognized by all inverters and does not need to be set specifically.

All masters and slaves connected to the same network must follow the same transmission principles (for example same bit rate, data format and protocol format) to ensure normal communication. Therefore, settings for F10.01 (bit rate), F10.02 (data format) and F10.10 (communication protocol; default: Modbus-RTU protocol for EM600) for all devices connected to the network are the same.

Function Code	Name of Function Code	Parameter Description	Unit	Default	Property
F10.01	Modbus Communication Bit Rate	0: 4800 1: 9600 2: 19200 3: 38400 4: 57600 5: 115200	bps	1	○

EM600 Inverter supports 6 bit rates (unit: bit/s) when it is in Modbus-RTU communication. If F10.01=9600 bps, it means that 9600 bits will be transmitted for each second. Under default applications, to transmit each byte of valid data (for example 0x01), actual transmission is 10 bits and the time needed is about 1.04 ms (about 1.04167 ms=10bit/9600 bps).

Function Code	Name of Function Code	Parameter Description	Unit	Default	Property
F10.02	Modbus Data Format	0: 1-8-N-1 (1 start bit + 8 data bits + 1 stop bit) 1: 1-8-E-1 (1 start bit + 8 data bits + 1 even parity + 1 stop bit) 2: 1-8-O-1 (1 start bit + 8 data bits + 1 odd parity + 1 stop bit) 3: 1-8-N-2 (1 start bit + 8 data bits + 2 stop bits) 4: 1-8-E-2 (1 start bit + 8 data bits + 1 even parity + 2 stop bits) 5: 1-8-O-2 (1 start bit + 8 data bits + 1 odd parity + 2 stop bit)		0	○

When transmitting data via Modbus protocol of RTU format, inverter supports 6 different data formats according to data combinations. When transmitting data via Modbus protocol of RTU format, inverter supports 6 different data formats according to data combinations.

Start bit	Valid data								Parity	Stop bit
1	7	6	5	4	3	2	1	0	N/O/E	1

If F10.02=0, it means that present data format is 1 start bit + 8 data bits + no parity + 1 stop bit

★ N (NONE), no parity; E (EVEN), even parity; O (ODD), odd parity.

Inverter also supports communication overtime and response delay, when it is networked for communication with Modbus protocol, in order to meet various requirements.

Function Code	Name of Function Code	Parameter Description	Unit	Default	Property
F10.03	Communication Overtime	0.0 - 60.0, 0.0: Disabled (also works for master - slave system)	s	0.0	●

As shown in Figure 7-30, communication interval Δt refers to the period from previous receipt of valid data frame by slave (inverter) to its receipt again. If Δt is greater than set time (see F10.03; this function is disabled if it is set as 0), this is called “communication overtime”.

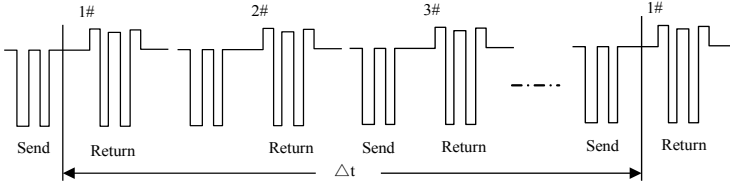

Figure 7-30 Communication Overtime

Application example: If master must send data to a slave (for example #1) within a certain time T , then user can enable communication overtime function for #1 slave by setting $F10.03 > T$. No fault report for communication overtime will be triggered during normal communication. However, if master does not send data to #1 slave for a time period T and this condition is maintained for a time set by F10.03, then a communication fault ($E 15$) will be reported to notify personnel of “#1 slave communication fault”, so that the personnel may conduct troubleshooting.

★ The time set by F10.03 must be greater than T , but must not be excessive, otherwise running of inverter under fault condition for a long time can result in adverse effects.

★ F10.03 should be 0.0 (disabled) usually. It’s useful only for continues communication in order to monitor the status of communication.

Function Code	Name of Function Code	Parameter Description	Unit	Default	Property
F10.04	Modbus Response Delay	1 - 20	ms	2	●

Define the time interval from receipt of valid data frame 1 by inverter, to data learning, and then to starting data return, as response delay (t_{w2}). To ensure that the protocol chip works stably, response delay shall be set as 1 ms to 20 ms (no 0). If communication data involves EEPROM, actual response delay will be extended to “EEPROM action time + F10.04”.

1: valid data frame: sent by external master to inverter, and function code, data length and CRC are correct.

As shown in Figure 7-31, data sending section (t_s), sending end mark section (t_{w1}), 75176 forwarding waiting section (t_{w2}), data return section (t_r) and 75176 receipt section (t_{w3}).

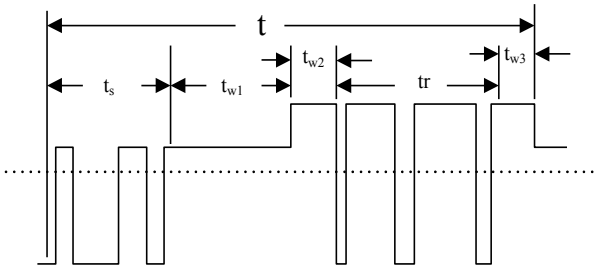

Figure 7-31 Complete Data Frame Time Sequence Learning

Function Code	Name of Function Code	Parameter Description	Unit	Default	Property
F10.05	Master-Slave Communication Function	0: Disabled 1: Enabled		0	○
F10.06	Master-Slave Options	0: Slave 1: Master (Sent by Broadcast)		0	○
F10.07	Data Sent by Master	0: Output Frequency 1: Set Frequency 2: Output Torque 3: Set Torque 4: PID Setting 5: Output Current		1	○
F10.08	Receiving Proportionality Factor of Slave	0.00 - 10.00 (Times)		1.00	●
F10.09	Sending Interval of Master	0.000 - 30.000	s	0.200	●

EM600 supports master-slave communication function. In master-slave communication, one inverter is used as master while other inverters are slaves; all slaves work as the command sent by master to achieve the synchronous running function of multiple inverters.

- For master, inverter will be set as follows:
Set F10.05=1 to enable master-slave function;
Set F10.06=1 to set present inverter as master (only one inverter can be used as master in a network);
F10.07 is used to set the variable needing synchronization; for example output current, set F10.07=5.
- For a slave, inverter will be set as follows:
Set F10.05=1 to enable master-slave function;
Set F10.06=0 to select present inverter as a slave;
Set a setting as communication setting; for example, if F09.00=6, and process PID is set individually (F00.05=10 and F00.06=1), slave inverter will take output current of master as setting for PID regulation.

For a slave, F10.08 can be used to determine how inverter makes use of received data. If F10.08=0.80, finally used data is “Recv (Received Data) * 0.80 (F10.08)”.

For master, F10.09 can be used to determine how long a command is sent by master.

Function Code	Name of Function Code	Parameter Description	Unit	Default	Property
F10.10	Communication Protocol	0: Modbus-RTU Protocol 1: Profibus-DP Protocol		0	○

Function Code	Name of Function Code	Parameter Description	Unit	Default	Property
		2: CANopen Protocol 3: DeviceNet Protocol			

EM600 inverter supports multiple communication protocols. Except inverter for Modbus-RTU, user must buy an expansion card of the company independently. Please contact your dealer if necessary.

Function Code	Name of Function Code	Parameter Description	Unit	Default	Property
F10.11	Communication Address of Profibus-DP Expansion Card	1 - 125		1	○
F10.12	Communication Address of CANopen Expansion Card	1 - 127		1	○
F10.13	Communication Address of DeviceNet Expansion Card	0 - 63		1	○

For setting of address of communication expansion card, user only needs to set function code corresponding to present expansion card.

Function Code	Name of Function Code	Parameter Description	Unit	Default	Property
F10.14	Response Delay Time of Process Data of Communication Card	0.0 - 200.0	ms	0.0	○

This function code is used to determine the delay response time of communication card after master sends data to communication card.

Function Code	Name of Function Code	Parameter Description	Unit	Default	Property
F10.15	Bit Rate of Communication between Expansion Card and Bus	Ones Place: CANopen 0: 125K 1: 250K 2: 500K 3: 1M Tens Place: DeviceNet 0: 125K 1: 250K 2: 500K		23	○

When selecting a communication expansion card, CANopen or DeviceNet, user needs to set bit rates for communication between expansion card and bus.

Function Code	Name of Function Code	Parameter Description	Unit	Default	Property
F10.16	PROFIBUS Communication Format	0: PPO1 1: PPO2 2: PPO3 3: PPO4 4: PPO5			×

When a selected expansion card is Profibus-DP, user needs to set communication format. Please refer to expansion card manual for details.

Function Code	Name of Function Code	Parameter Description	Unit	Default	Property
F10.17	Received Data Type PZD2	When the displayed data is 65535, it means that present PZD is not used. When the displayed data is other data, for example 4609, it means that the function parameter is F18.01 (18D=12H, 01D=01H, 1201H=4609D)		65535	○
F10.18	Received Data Type PZD3			65535	○
F10.19	Received Data Type PZD4			65535	○
F10.20	Received Data Type PZD5			65535	○
F10.21	Received Data Type PZD6			65535	○
F10.22	Received Data Type PZD7			65535	○
F10.23	Received Data Type PZD8			65535	○
F10.24	Received Data Type PZD9			65535	○
F10.25	Received Data Type PZD10			65535	○
F10.26	Received Data Type PZD11			65535	○
F10.27	Received Data Type PZD12			65535	○
F10.28	Received Data Type PZD13			65535	○
F10.29	Received Data Type PZD14			65535	○
F10.30	Received Data Type PZD15			65535	○
F10.31	Received Data Type PZD16			65535	○
F10.32	Sent Data Type PZD2			65535	○
F10.33	Sent Data Type PZD3			65535	○
F10.34	Sent Data Type PZD4			65535	○
F10.35	Sent Data Type PZD5			65535	○
F10.36	Sent Data Type PZD6			65535	○
F10.37	Sent Data Type PZD7			65535	○
F10.38	Sent Data Type PZD8			65535	○
F10.39	Sent Data Type PZD9			65535	○
F10.40	Sent Data Type PZD10			65535	○
F10.41	Sent Data Type PZD11			65535	○
F10.42	Sent Data Type PZD12			65535	○
F10.43	Sent Data Type PZD13			65535	○
F10.44	Sent Data Type PZD14			65535	○
F10.45	Sent Data Type PZD15			65535	○
F10.46	Sent Data Type PZD16			65535	○

F10.17 - F10.31 are used to define data sent from communication expansion card (i.e., received by inverter) and are generally parameter settings; F10.32 - F10.46 are used to define data received by communication expansion card (sent by inverter) and are generally status parameters. All the exchange data shall correspond to these functions codes or the defined fields of virtual addresses and not be manually set. Refer to communication expansion card instructions. All the exchange data correspond to function codes or virtual

address definition areas respectively (refer to Communication Protocol) and user does not need to set them manually. Refer to corresponding manuals of communication expansion cards.

Function Code	Name of Function Code	Parameter Description	Unit	Default	Property
F10.47	Communication Card Status	<p>Ones Place: Profibus-DP 0: Initialization Status 1: Wait for Parameterization Status 2: Wait for Configuration Status 3: Data Exchange Status 4: Modbus Communication Fault Status 5: Factory Test Status Place: CANopen 0: Initialization Status 1: Pre-Operation Status 2: Operation Status 3: Stop Status 4: CANopen Communication Fault Status 5: Modbus Communication Fault Status 6: Factory Test Status Hundreds Place: DeviceNet 0: Initialization Status 1: MACID Detection Status 2: Online Non-Connection Status 3: Connection Status 4: IO Communication Overtime Status 5: DeviceNet Bus Communication Fault Status 6: Modbus Communication Fault Status 7: Factory Test Status</p>		000	×

Communication card only read the parameters. Refer to corresponding manuals of communication expansion cards.

Function Code	Name of Function Code	Parameter Description	Unit	Default	Property
F10.48	Communication Card Software Version				×

Communication card only read the parameters.

Function Code	Name of Function Code	Parameter Description	Unit	Default	Property
F10.49	number of process data	1~16		2	●

	received				
F10.50	number of process data transmission	1~16		2	●
F10.51	Process data address setting mode selection	0: keypad 1: Master		0	●
F10.52	Communication card manual reset selection	0: disable 1: enable		0	●



Refer to corresponding manuals of communication expansion cards.

Function Code	Name of Function Code	Parameter Description	Unit	Default	Property
F10.56	RS485Write EEPROM	0~10: default for debugging 11: No trigger write before debugging		0	○

For application of PLC/HMI + inverter, after the adjustment is completed, if F10.56=11 PLC communications written data is not stored in order to avoid writing memory error problem.

If you need to set parameters and require power off storage you can set F10.56=0 before operation.

7.12 F11 Group: User-Defined Parameter

Keypad of EM600 inverter supports user-defined mode. First, by setting F11, user may select a function code and enter user-defined mode (--U--, see 4.2.2). Through  and , user may switch to desired function code circularly. This function is mainly applied to occasions of less than 32 function codes so as to avoid troubles of too many function codes.

Function Code	Name of Function Code	Parameter Description	Unit	Default	Property
F11.00	User-Defined Parameter 1	The content displays Uxx.xx, which means that Fxx.xx function code is selected. If keypad displays U00.00 at the time of entering function code F11.00, it means that the first user-defined parameter is F00.00.		U00.00	●
F11.01	User-Defined Parameter 2			U00.01	●
F11.02	User-Defined Parameter 3			U00.02	●
F11.03	User-Defined Parameter 4			U00.03	●
F11.04	User-Defined Parameter 5			U00.04	●
F11.05	User-Defined Parameter 6			U00.07	●
F11.06	User-Defined Parameter 7			U00.14	●
F11.07	User-Defined Parameter 8			U00.15	●
F11.08	User-Defined Parameter 9			U00.16	●

Function Code	Name of Function Code	Parameter Description	Unit	Default	Property
F11.09	User-Defined Parameter 10			U00.18	●
F11.10	User-Defined Parameter 11			U00.19	●
F11.11	User-Defined Parameter 12			U00.29	●
F11.12	User-Defined Parameter 13			U02.00	●
F11.13	User-Defined Parameter 14			U02.01	●
F11.14	User-Defined Parameter 15			U02.02	●
F11.15	User-Defined Parameter 16			U03.00	●
F11.16	User-Defined Parameter 17			U03.02	●
F11.17	User-Defined Parameter 18			U03.21	●
F11.18	User-Defined Parameter 19			U04.00	●
F11.19	User-Defined Parameter 20			U04.20	●
F11.20	User-Defined Parameter 21			U05.00	●
F11.21	User-Defined Parameter 22			U05.03	●
F11.22	User-Defined Parameter 23			U05.04	●
F11.23	User-Defined Parameter 24			U08.00	●
F11.24	User-Defined Parameter 25			U19.00	●
F11.25	User-Defined Parameter 26			U19.01	●
F11.26	User-Defined Parameter 27			U19.02	●
F11.27	User-Defined Parameter 28			U19.03	●
F11.28	User-Defined Parameter 29			U19.04	●
F11.29	User-Defined Parameter 30			U19.05	●
F11.30	User-Defined Parameter 31			U19.06	●
F11.31	User-Defined Parameter 32			U19.12	●



F11.00=U00.00, means that the first user-defined parameter is function code F00.00. The switching sequence of function codes under user-defined mode set by keypad shall be the sequence set by function codes F11.00 - F11.31.

7.13 F12 Group: Keypad and Display Parameter

Function Code	Name of Function Code	Parameter Description	Unit	Default	Property
F12.00	M.K	0: No Function 1: Forward JOG 2: Reverse JOG 3: Forward/Reverse Switch 4: Rapid Stop 5: Coast to Stop 6: Cursor Left Shift		1	○

 is a multifunction key. By setting function code F12.00, its actual function will be realized. If F12.00=0, this function does not work; if F12.00=Any other value, press this key to realize corresponding function.

Function Code	Name of Function Code	Parameter Description	Unit	Default	Property
F12.01	STOP	0: Valid Only at Keypad Control 1: Valid at All Command Channels		1	○

According to setting of function code F00.02 (command source options), the command source has three control types, keypad control, terminal control and communication control, i.e., if terminal control is selected as command source, buttons  and  of keypad will be disabled. However, in emergency, user often uses  of keypad to stop inverter for the purpose of eliminating risks, which is the fastest way. However, during normal running of inverter, it is the most convenient way to stop inverter through keypad. Therefore, function code F12.01 is added and default setting is that STOP button is always enabled.

★ It's not recommended to modify this function code. If necessary, please pay enough attention.

Function Code	Name of Function Code	Parameter Description	Unit	Default	Property
F12.02	Parameter Locking	0: Unlocked 1: Reference Input, Unlocked 2: All Locked Except this Function Code		0	●

In order to avoid unnecessary risks caused by misoperation or non-personnel operation of keypad, keypad has the parameter locking function. If default setting of this function code is “unlocked”, you can set all function codes; after all function codes are debugged according to applications, user may lock parameters.

- 1: Reference Input, Unlocked

Under parameter locking mode, no function code can be modified except these ones with reference input and this function code. Specific function codes with the inference input are indicated in Table 7-17:

Table 7-17 Function Codes with Reference Input

Function Code	Name of Function Code	Parameter Description	Unit
F00.07	Numeric Frequency Setting	F08.11	Preset Speed 12
F08.00	Preset Speed 1	F08.12	Preset Speed 13
F08.01	Preset Speed 2	F08.13	Preset Speed 14
F08.02	Preset Speed 3	F08.14	Preset Speed 15
F08.03	Preset Speed 4	F13.02	Numeric Torque Setting
F08.04	Preset Speed 5	F09.01	Numeric PID Setting
F08.05	Preset Speed 6	F09.32	Preset PID Setting 1
F08.06	Preset Speed 7	F09.33	Preset PID Setting 2
F08.07	Preset Speed 8	F09.34	Preset PID Setting 3
F08.08	Preset Speed 9	F13.03	Preset Torque 1
F08.09	Preset Speed 10	F13.04	Preset Torque 2
F08.10	Preset Speed 11	F13.05	Preset Torque 3

● 2: All Locked Except this Function Code

Under parameter locking mode, no function code can be set except this one. This mode is mostly applied to applications that parameters have been set and debugged and no parameter setting is required. Under this mode, user only run, stop and monitor inverter.

Function Code	Name of Function Code	Parameter Description	Unit	Default	Property
F12.03	Parameter Copy	0: No Operation 1: Upload Parameter to Keypad 2: Download Parameter to Inverter		0	○

As for a working condition that multiple inverters shall run under the same parameter settings, user can debug one inverter; set F12.03=1 for it, and upload set parameters to keypad for temporary saving; then set F12.03=2 for the rest inverters, and now download the parameter settings to them. By using this function, user may set parameters of multiple inverters quickly. User may set most function codes at first even if there are still individual parameters with different settings, and user may complete setting of such individual parameter settings by other methods. (See 4.5 Parameter Copy)

Function Code	Name of Function Code	Parameter Description	Unit	Default	Property
F12.04	LED Display Parameter 1	00000000 - 11111111 (0 for non-displaying, 1 for displaying) bit0: Output Frequency bit1: Set Frequency bit2: Output Current bit3: Output Voltage bit4: DC Bus Voltage bit5: Output Power bit6: Output Torque bit7: Torque Setting		000 11111	●

Function Code	Name of Function Code	Parameter Description	Unit	Default	Property
F12.05	LED Display Parameter 2	00000000 - 11111111 (o for non-displaying, 1 for displaying) bit0: PG Feedback Frequency bit1: Estimated Feedback Frequency bit2: Load Speed bit3: Numeric Input Terminal Status 1 bit4: Numeric Input Terminal Status 2 bit5: Numeric Input Terminal Status 3 bit6: Numeric Input Terminal Status bit7: AI1		000 00000	•
F12.06	LED Display Parameter 3	00000000 - 11111111 (o for non-displaying, 1 for displaying) bit0: AI2 Bit1: AI3 Bit2: AI4 Bit3: PID Input bit4: PID Feedback bit5: Count Value bit6: Actual Length bit7: High-Frequency Pulse Input Frequency: kHz		000 00000	•
F12.07	LED Display Parameter 4	00000000 - 11111111 (o for non-displaying, 1 for displaying) bit0: High-Frequency Pulse Input Frequency, Hz bit1: kilowatt-hour meter, MWh bit2: kilowatt-hour meter, kWh bit3: Remaining Time of Timed Run bit4: Simple PLC Running Times bit5: Simple PLC Running Stage bit6: PLC Running Time of Present Stage bit7: Not Used		000 00000	•
F12.08	LED Display Parameter 5	00000000 - 00001111 (o for non-displaying, 1 for displaying) bit0: UP/DOWN Offset bit1: VF Separation Output Voltage bit2: VF Separation Target Voltage bit3: Motor Temperature bit4 - bit7: Not Used		*0000	•

User may press ESC to enable inverter to enter monitoring mode (see 4.4 Operation Monitoring); now, press  to switch among parameters circularly. Function codes F12.04 - F12.05 are used to select which parameters are to be displayed, i.e., parameters are in a circular display queue. Selected options correspond to the F18 Group: Monitoring Parameter, so user may enter F18 to view present values of all parameters. This function is mainly for fast display, especially during running period.

Under default applications, circular display queue only displays some commonly used options, respectively output frequency (F18.00), set frequency (F18.01), output current (F18.06), output voltage (F18.08) and DC bus voltage (F18.08). If other parameters are required for display, please set these parameters as 1; if not, set them as 0.

★ Please pay enough attention when retaining some function codes.



Function Code	Name of Function Code	Parameter Description	Unit	Default	Property
F12.09	Load Speed Display Factor	0.01 - 600.00		30.00	●



Inverter output is mostly displayed in frequency. To get to know present load speed (F18.14), user may set present parameter according to actual applications, so as to convert frequency output into speed output; as a result, F18.14 would be used to display present load speed.

If F12.09=30.00 (this value is relative to pole-pairs, device transmission ratio, etc.), then output frequency 0.00 - 50.00 Hz correspond to load speed 0 - 1500 rpm.

Function Code	Name of Function Code	Parameter Description	Unit	Default	Property
F12.10	UP/DOWN Acceleration/Deceleration Rate	0.00: Automatic Rate 0.01 - 500.00	Hz/s	5.00	○
F12.11	UP/DOWN Offset Clear	0: Not to Clear 1: Clear at Non-Running Status 2: Clear at Disabled UP/DOWN		1	○
F12.12	Power Failure Save of UP/DOWN Offset	0: Disabled 1: Enabled (only at modified offset)		0	○

UP/DOWN can be classified into keypad UP/DOWN and terminal UP/DOWN, which can be enabled individually and simultaneously.

- Keypad UP/DOWN: Only enabled at the level 0 monitoring menu, which is under control of  and  on keypad.

By pressing / under the monitoring menu, offset frequency increases/decreases at the rate set through F12.10; at this time, keypad displays “F18.15: UP/DOWN Offset Frequency” and the final frequency is the sum of set frequency and offset frequency. After releasing the button for 1s, keypad displays normally.

- Terminal UP/DOWN: By setting the numeric input terminal as corresponding function, inverter is under terminal control. When terminal UP/DOWN is on, offset frequency increases/decreases at the rate set through F12.10 and final frequency is the sum of set frequency and offset frequency. Keypad display remains unchanged during the period.

★ When keypad UP and terminal down (or keypad DOWN and terminal UP) are enabled at the same time, offset frequency fluctuates due to different valid time points, although acceleration/deceleration speed does not change. It is a normal phenomenon.

Function Code	Name of Function Code	Parameter Description	Unit	Default	Property
F12.13	Kilowatt-Hour Meter Clear	0: Not to Clear 1: Clear		0	●

EM600 inverter has a kilowatt-hour meter function (refer to description of F18.18 and F18.19). User may set present function code as 1 to clear present count.

Function Code	Name of Function Code	Parameter Description	Unit	Default	Property
F12.14	Reset	0: No Operation 1: Reset (exclusive of motor parameter, inverter parameter, manufacturer parameter, running and power-on time record)		0	○

By setting this parameter as 1, user may reset all parameters except motor parameter (F01 group), inverter parameter, manufacturer parameter, power-on time (F12.15/16) and running time (F12.17 and F12.18).

★: This operation is irreversible. Please pay enough attention while operating.

Function Code	Name of Function Code	Parameter Description	Unit	Default	Property
F12.15	Accumulated Power-On Time h	0 - 65535	h	0	×
F12.16	Accumulated Power-On Time min	0 - 59	min	0	×

F12.15 and F12.16 are used together to view accumulated power-on time from inverter manufacture until now (as per the time that inverter is powered on). This value will be accurate to 1 minute, and up to about 65,536 hours (about 7.5 years).

If F12.15=50 and F12.16=33, it means that accumulated power-on time of inverter is 2 days 2 hours and 33 minutes.

★ These parameters are used for viewing only and can not be operated or cleared.

Function Code	Name of Function Code	Parameter Description	Unit	Default	Property
F12.17	Accumulated Running Time h	0 - 65535	h	0	×
F12.18	Accumulated Running Time (min)	0 - 59	min	0	×

F12.17 and F12.18 are used together to view accumulated power-on time from inverter manufacture until now (as per the time that inverter runs). This value will be accurate to 1 minute, and up to about 65,536 hours (about 7.5 years).

If F12.17=47 and F12.18=39, it means that accumulated power-on time of inverter is 1 day 23 hours and 39 minutes.

★ These parameters are used for viewing only and can not be operated or cleared.

Function Code	Name of Function Code	Parameter Description	Unit	Default	Property
F12.19	Inverter Rated Power	0.40 - 650.00	kW	Up To Specific Model	×
F12.20	Inverter Rated Voltage	60 - 690	V	Up To Specific Model	×
F12.21	Inverter Rated Current	0.1 - 1500.0	A	Up To Specific Model	×

These function codes are used to view rated power, rated voltage and rated current of inverter.

★ These parameters are used for viewing only and can not be operated.

Function Code	Name of Function Code	Parameter Description	Unit	Default	Property
F12.22	Performance Software Serial Number1	XXX.XX		XXX.XX	×
F12.23	Performance Software Serial Number2	XX.XXX		XX.XXX	×
F12.24	Function Software Serial Number 1	XXX.XX		XXX.XX	×
F12.25	Function Software Serial Number 2	XX.XXX		XX.XXX	×
F12.26	Keypad Software Serial Number 1	XXX.XX		XXX.XX	×
F12.27	Keypad Software Serial Number 2	XX.XXX		XX.XXX	×

These function codes are used to view software version of inverter.

★These parameters are used for viewing only and can not be operated.

Function Code	Name of Function Code	Parameter Description	Unit	Default	Property
F12.28	Product Serial Number 1	XX.XXX		XX.XXX	×
F12.29	Product Serial Number 2	XXXX.X		XXXX.X	×
F12.30	Product Serial Number 3	XXXXX		XXXXX	×

These function codes are used to view the type of present product.

★These parameters are used for viewing only and can not be operated.

Function Code	Name of Function Code	Parameter Description	Unit	Default	Property
F12.31	LCD Language	0: Chinese 1: English 2: Not Used		0	●

LCD language chooses.

Function Code	Name of Function Code	Parameter Description	Unit	Default	Property
F12.32	Monitor mode	0: Mode 0 1: Mode 1		1	●
F12.33	Mode 1 display parameter 1 (LED Stop status display parameter 5)	0.00~99.99		18.00	●
F12.34	Mode 1 display parameter 2 (LED Stop status display parameter 1)	0.00~99.99		18.01	●
F12.35	Mode 1 display parameter 3 (LED Stop status display parameter 2)	0.00~99.99		18.06	●
F12.36	Mode 1 display parameter 4 (LED Stop status display parameter 3)	0.00~99.99		18.08	●
F12.37	Mode 1 display parameter 5 (LED Stop status display parameter 4)	0.00~99.99		18.09	●

F12.32=0: Mode 0. Switching LED display and LCD (7 Lines) function code display is set by F12.04 – F12.08. The selected function codes refer to the parameter description.

F12.32=1: Mode 1. Switching LED display and LCD (7 Lines) function code display is set by F12.33 – F12.37. For example, if 18.00 is set it means that the function code is F18.00.

Function Code	Name of Function Code	Parameter Description	Unit	Default	Property
F12.38	LCD display parameter 1	0.00~99.99		18.00	●
F12.39	LCD display parameter 2	0.00~99.99		18.06	●
F12.40	LCD display parameter 3	0.00~99.99		18.09	●

Default display (3 lines) is 3 function codes for monitoring F18.00, F18.06 and F18.09. LCD display 3 lines switches to LCD display 7 lines.

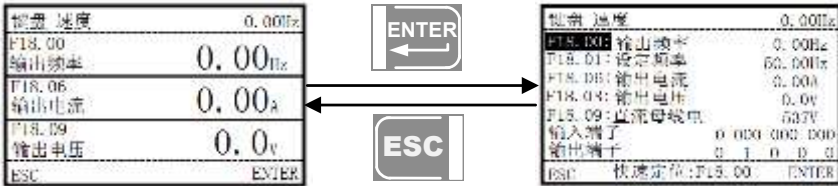

Related operations please refer to the LCD keypad manual.

Monitor mode please refer to chapter 4.

Function Code	Name of Function Code	Parameter Description	Unit	Default	Property
F12.41	UP/DOWN cross zero option	0: forbidden 1: allowed		0	○

When UP/DOWN is enabled and F12.41=0 UP/DOWN will reduce inverter output frequency to 0 and not reverse. If 12.41=1 UP/DOWN will reduce inverter output frequency to 0 and can reverses.

7.14 F13 Group: Torque Control Parameter

Function Code	Name of Function Code	Parameter Description	Unit	Default	Property
F13.00	Speed/Torque Control	0: Speed Control 1: Torque Control		0	○

F13.00=0: Speed Control

The control mode is speed input type, with frequency as input quantity.

F13.00=1: Torque Control

Input control mode is torque input, with the percentage of motor rated torque current as the input quantity; it is only enabled when inverter is in SVC control or FVC control mode, i.e., when F00.01=1 or 2; in FVC control mode, the squirrel-cage induction motor can achieve torque control to replace AC induction torque motor directly.

Final control mode is also related to “29: Torque Control Disabled” and “28: Switch between Speed Control and Torque Control”. See corresponding description.

Table 7-18 Final Control Mode of Inverter

29: Torque Control Disabled	28: Switch between Speed Control and Torque Control	F13.00 F13.00	Final Control Mode
-----------------------------	---	---------------	--------------------

29: Torque Control Disabled	28: Switch between Speed Control and Torque Control	F13.00 F13.00	Final Control Mode
Enabled	*	*	Speed Control
Disabled	Enabled	0	Torque Control
		1	Speed Control
	Disabled	0	Speed Control
		1	Torque Control

Function Code	Name of Function Code	Parameter Description	Unit	Default	Property
F13.01		0: Numeric Torque Setting F13.02 1: AI1 2: AI2 3: AI3 4: AI4 (Expansion Card) 5: High-Frequency Pulse Input (X7) 6: Communication Setting (Full ranges of options 1 to 6 correspond to numeric torque setting F13.02)		0	○
F13.02	Numeric Torque Setting	-200.0 - 200.0 (100.0= Motor Rated Torque)	%	100.0	●

F13.01=0: Numeric Torque Setting F13.02

Torque is set through F13.02.

F13.01=1: AI1

F13.01=2: AI2

F13.01=3: AI3

F13.01=4: AI4 (Expansion Card)

Torque is controlled by AI (percentage) * F13.02.

F13.01=5: High-Frequency Pulse Input (X7)

Torque is controlled by HDI (percentage) * F13.02.

Please refer to the description of F00.04 for detailed explanations of AI1-AI4 and X7.

F00.04 has the same meanings as AI1-AI4 and X7. 100.00% is the percentage inputted through F13.02 (Numeric Torque Setting).

F13.01=6: Communication Setting

Torque is determined by communication, etc.

- If inverter is under master-slave communication control (F10.05=1) and present inverter is a slave (F10.06=0), set percentage is “700FH (Master-Slave Communication Setting) * F10.08 (Receiving Proportionality Factor of Slave)”. Range of 700FH is -100.00% to 100.00%. See Table 12-2 for details.
- For general communication (F10.05=0), set percentage is “7003H (Torque Communication Setting) * F00.18 (Numeric Torque Setting)”. Range of 7003H is -200.00% to 200.00%. See Table 12-2 for details.

Function Code	Name of Function Code	Parameter Description	Unit	Default	Property
F13.03	Preset Torque 1	-200.0 - 200.0	%	0.0	●
F13.04	Preset Torque 2	-200.0 - 200.0	%	0.0	●
F13.05	Preset Torque 3	-200.0 - 200.0	%	0.0	●

To realize the diversification of torque application, EM600 inverter supports preset torque function. Set input terminal “17: Preset Torque Terminal 1” and “18: Preset Torque Terminal 2” See Table 7-19 for details.

Table 7-19 Preset Torque Commands and Preset Torque Terminals

18: Preset Torque Terminal 2	17: Preset Torque Terminal 1	Torque Number	Torque Setting
Disabled	Disabled	Preset Torque 1	Set through F13.01
Disabled	Enabled	Preset Torque 2	F13.03 F13.03
Enabled	Disabled	Preset Torque 3	F13.04 F13.04
Enabled	Enabled	Preset Torque 4	F13.05 F13.05

Function Code	Name of Function Code	Parameter Description	Unit	Default	Property
F13.06	Torque Control Acceleration/Deceleration Time	0.00 - 120.00	s	0.00	●

Setting F13.06 can make the motor speed change smoothly.

The value set by F13.06 refers to the time that torque current increases from 0 to rated torque current or decreases from rated current to 0.

Function Code	Name of Function Code	Parameter Description	Unit	Default	Property
F13.08	Upper Limit Frequency of Torque Control	0: Set through F13.09 1: AI1 2: AI2 3: AI3 4: AI4 (Expansion Card) 5: High-Frequency Pulse Input (X7) 6: Communication Percentage Setting 7: Communication Direct Setting		0	○
F13.09	Upper Limit Frequency of Torque Control	0.00 - Maximum Frequency F00.16	Hz	50.00	●
F13.10	Upper Limit Frequency Offset	0.00 - Maximum Frequency F00.16	Hz	0.00	●
F13.18	Reverse speed limit selection	0 - 100	%	100	●
F13.19	Torque Control Speed Priority Selection	0: Disabled 1: Enabled		0	●

F13.08=0: Set through F13.09

Under torque control mode, upper limit frequency is set through F13.09.

F13.08=1: AI1**F13.08=2: AI2****F13.08=3: AI3****F13.08=4: AI4 (Expansion Card)**

Under torque control mode, upper limit frequency is set through AI (percentage) * F13.09.

F13.08=5: High-Frequency Pulse Input (X7)

Under torque control mode, upper limit frequency is set through HDI (percentage) * F13.09.

Please refer to the description of F00.04 for detailed explanations of AI1-AI4 and X7. F00.04 has the same meanings as AI1-AI4 and X7. 100.00% is the percentage inputted through F13.09 (Upper Limit Frequency of Torque Control).

F13.08=6 or 7: Communication Setting

Torque is determined by communication, etc.

- If inverter is under master-slave communication control (F10.05=1) and present inverter is a slave (F10.06=0), set upper limit frequency is “700FH (Master-Slave Communication Setting) * F10.08 (Receiving Proportionality Factor of Slave)* F00.18 (Upper Limit Frequency)”. Range of 700FH is -100.00% to 100.00%. See Table 12-2 for details.
- For general communication (F10.05=0)

a) If F13.08=6 upper limit frequency is 700BH (Upper Limit Frequency Percentage Setting of Torque Control) * F13.09 (Upper Limit Frequency of Torque Control)

b) If F13.08=7 upper limit frequency is 7018H (Upper Limit Frequency Setting of Torque Control)

Range of 700BH is 0.00% to 200.00%. Range of 7018H is 0.00% to F00.16 (Maximum Frequency).See Table 12-2 for details.

Function Code	Name of Function Code	Parameter Description	Unit	Default	Property
F13.11	Static Friction Torque Compensation	0.0 - 100.0	%	0.0	●
F13.12	Static Friction Compensation Frequency Range	0.00 - 50.00	Hz	1.00	●
F13.13	Kinetic Friction Torque Compensation	0.0 - 100.0	%	0.0	●

In driving an object, motor must overcome the static/kinetic friction. Setting this group of parameters can enable the torque to rotate as per the specified torque after having overcome the inherent static/kinetic friction force. The static friction prevails before motor runs, but the kinetic friction prevails after motor runs. All in all, this group of parameters is related to motor capacity performance.

This group of parameters can be interpreted like this: when actual frequency (or estimated frequency if inverter is in SVC control; or PG card feedback frequency if inverter is in FVC control mode) is less than or equal to the value set through F13.11, then output torque is “set frequency + F13.11 Static Friction Torque Compensation Factor”. When actual frequency is greater than the value set through F13.11, output torque is “Set Torque + F13.13 Kinetic Friction Torque Compensation Factor”. The greater compensation factor is, the higher the compensation level will be. The percentage of the compensation factor is equal to the torque setting percentage.

7.15 F14 Group: Motor 2 Parameter

EM600 inverter can be switched between two motors. User may perform motor nameplate parameter settings, motor parameter tuning, selection of VF control or vector control, related parameters of encoder, and parameters related to VF control or vector control performance for these two motors respectively.

Motor parameters of the second group are listed in F14, with function codes having the same meanings as that of the first group. F14.00 - F14.34 correspond to F01.00 - F01.34 and they are respectively motor nameplate parameter, motor parameter, encoder parameter, etc.; F14.35 corresponds to F00.01, for motor control mode; F14.36 - F14.76 corresponds to F06.00 - F06.40, as vector control parameters; F14.77 refers to acceleration/deceleration options for motor 2. In the following, only F14.77 is described. For other parameters, please refer to relevant parameter of Motor 1.

Function Code	Name of Function Code	Parameter Description	Unit	Default	Property
F14.77	Motor 2 Acceleration/Deceleration Time	0: Same as Motor 1 1: Acceleration/Deceleration Time 1 2: Acceleration/Deceleration Time 2 3: Acceleration/Deceleration Time 3 4: Acceleration/Deceleration Time 4		0	○

F14.77=0, acceleration/deceleration time of motor 2 is the same as that of motor 1. Refer to description of F15.03 - F15.09.

F14.77=1/2/3/4, acceleration/deceleration time of motor 2 is fixed as acceleration/deceleration time 1, 2, 3 and 4, which correspond to F00.14 - F00.15/F15.03 - F15.04/F15.05 - F15.06/F15.07 - F15.08 respectively.

7.16 F15 Group: Auxiliary Function

Function Code	Name of Function Code	Parameter Description	Unit	Default	Property
F15.00	JOG Frequency	0.00 - Maximum Frequency F00.16	Hz	5.00	●
F15.01	JOG Acceleration Time	0.00 - 650.00 (F15.13=0) 0.0 - 6500.0 (F15.13=1) 0 - 65000 (F15.13=2)	s	5.00	●
F15.02	JOG Deceleration Time	0.00 - 650.00 (F15.13=0) 0.0 - 6500.0 (F15.13=1) 0 - 65000 (F15.13=2)	s	5.00	●

As indicated in Figure 7-32, if FJOG/RJOG is enabled, inverter will start running at the frequency by F15.00; after it is disabled, inverter will stop as per stop mode.

When inverter is running, F15.01 and F15.02 are set as acceleration and deceleration time. However, set values (for example 500) have different meanings and ranges, depending upon time unit (F15.13). If F15.13=0, it means that acceleration/deceleration time is 5.00s; if F15.13=1, it means that acceleration/deceleration time is 50.0s.

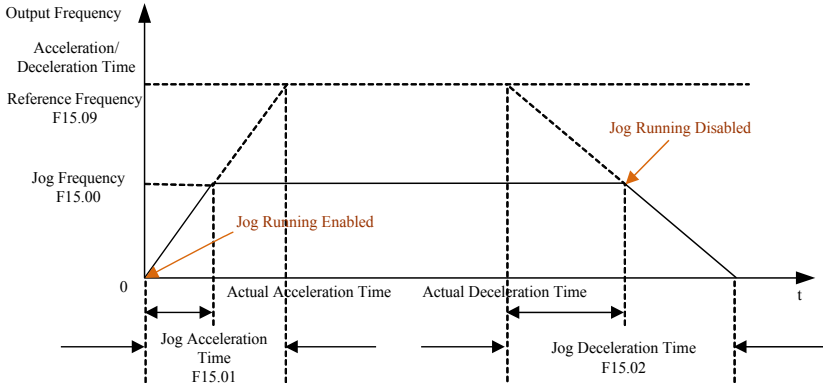

Figure 7-32 Jog Running

For JOG running mode, user may independently set frequency and acceleration/deceleration time, which shall not be shared but not having the same physical meaning with normal running.

Trigger applications for JOG running command depend upon inverter control modes. See Table 7-20 for details.

Table 7-20 JOG Running Command

Command Source Options (F00.02)	JOG Running Command
0: Keypad Control	M.K (F12.00) can be set as “1: FJOG” or “2: RJOG”. Press [M.K] , then JOG running command is enabled; release [M.K] , then JOG running command is disabled. ★ Remove keypad during JOG running to stop inverter.
1: Terminal Control	Numeric input terminal function “4: FJOG” or “5: RJOG”. Under default applications, if function terminal is enabled, JOG running command is active; if function terminal is disabled, JOG running command is inactive.
2: Communication Control	If host controller writes “0003H: FJOG” or “0004: RJOG” in the register 7000H through MODBUS protocol, JOG running command will be active; writes “0007H: coast to stop”, JOG running command will be inactive.

Function Code	Name of Function Code	Parameter Description	Unit	Default	Property
F15.03	Acceleration Time 2	0.00 - 650.00 (F15.13=0) 0.0 - 6500.0 (F15.13=1) 0 - 65000 (F15.13=2)	s	15.00	●
F15.04	Deceleration Time 2	0.00 - 650.00 (F15.13=0) 0.0 - 6500.0 (F15.13=1) 0 - 65000 (F15.13=2)	s	15.00	●
F15.05	Acceleration Time 3	0.00 - 650.00 (F15.13=0) 0.0 - 6500.0 (F15.13=1) 0 - 65000 (F15.13=2)	s	15.00	●

Function Code	Name of Function Code	Parameter Description	Unit	Default	Property
F15.06	Deceleration Time 3	0.00 - 650.00 (F15.13=0) 0.0 - 6500.0 (F15.13=1) 0 - 65000 (F15.13=2)	s	15.00	●
F15.07	Acceleration Time 4	0.00 - 650.00 (F15.13=0) 0.0 - 6500.0 (F15.13=1) 0 - 65000 (F15.13=2)	s	15.00	●
F15.08	Deceleration Time 4	0.00 - 650.00 (F15.13=0) 0.0 - 6500.0 (F15.13=1) 0 - 65000 (F15.13=2)	s	15.00	●
F15.09	Acceleration/Deceleration Time Reference Frequency	0: Maximum Frequency F00.16 1: 50 Hz		0	○

As for normal running (non jog running), the system offers 4 groups of acceleration/deceleration time options (first group F00.14 and F00.15) to meet different demands. After setting, user can switch between numeric input modes “19: Acceleration/Deceleration Time Terminal 1” and “20: Acceleration/Deceleration Time Terminal 2”. See Table 7-4 Numeric Multi-Function Input Terminals.

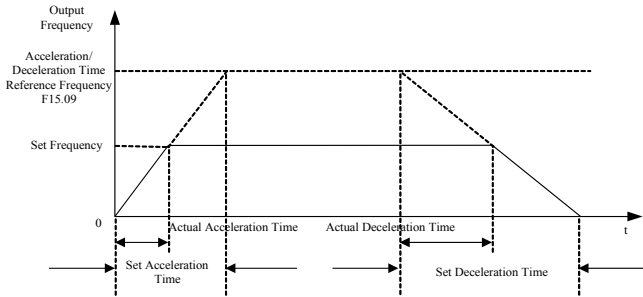

Figure 7-33 Acceleration/Deceleration Time

As indicated in Figure 7-33, defined acceleration time refers to the time that frequency increases from 0.00 Hz to acceleration/deceleration time reference frequency; deceleration time refers to the time that frequency decreases from acceleration/deceleration time reference frequency to 0.00 Hz. Actual acceleration/deceleration time depends upon the ratio of set frequency to reference frequency.

F15.09 is used to set acceleration/deceleration time reference frequency. If F15.09=0, reference frequency is set by F00.16 (maximum frequency). If also F00.16=100.00 Hz, acceleration time refers to the time that output frequency increases from 0.00 Hz (100.00 Hz) to 100.00 Hz (0.00 Hz), and deceleration time refers to the time that output frequency decreases from 100.00 Hz (0.00 Hz) to 0.00 Hz (100.00 Hz).

Function Code	Name of Function Code	Parameter Description	Unit	Default	Property
F15.10	Automatic Switching between Acceleration and Deceleration Time	0: Disabled 1: Enabled		0	○
F15.11	Switching Frequency between Acceleration Time 1 and Acceleration Time 2	0.00 - Maximum Frequency F00.16	Hz	0.00	●

F15.12	Switching Frequency between Acceleration Time 1 and Acceleration Time 2	0.00 - Maximum Frequency F00.16	Hz	0.00	●
--------	---	---------------------------------	----	------	---

If inverter runs at a common (other than PLC, PID, etc.) speed (other than torque, etc.) of motor 1 and acceleration and deceleration time terminals (19: Acceleration/Deceleration Time Terminal 1, 19: Acceleration/Deceleration Time Terminal 1) are disabled, inverter can complete automatic switching between the two terminals by setting F15.10 as 1. See Figure 7-34 for details.

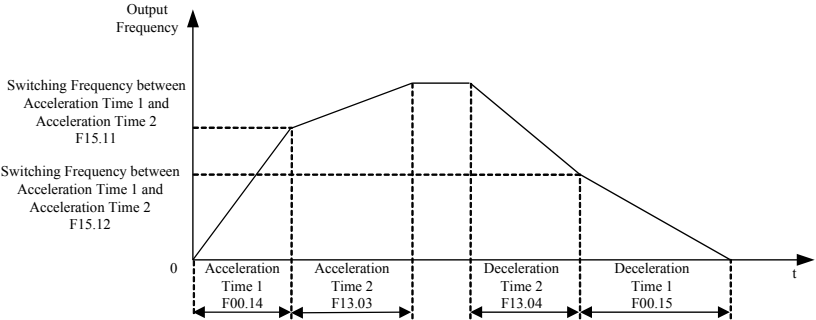

Figure 7-34 Automatic Switching between Acceleration Time and Deceleration Time
 In acceleration, if output frequency is less than F15.11, then acceleration time 1 is present acceleration time, otherwise, acceleration time 2 is present acceleration time.
 In deceleration, if output frequency is less than F15.12, then deceleration time 1 is present deceleration time, otherwise, deceleration time 2 is present deceleration time.

Function Code	Name of Function Code	Parameter Description	Unit	Default	Property
F15.13	Acceleration/Deceleration Time Unit	0:0.01s 1:0.1s 2:1s		0	○

Probably, acceleration/deceleration time can be a large figure depending upon different applications. The system offers 3 kinds of acceleration/deceleration time units, which are set through F15.13. If F15.13=1, it means that acceleration/deceleration time unit is “0.1 s”. Except F13.06 (Torque Control Acceleration/Deceleration Time) others acceleration and deceleration time will be changed. For example, in default conditions the value of F00.14 will change from 15.00s to 150.0s.

Function Code	Name of Function Code	Parameter Description	Unit	Default	Property
F15.14	Hopping Frequency Point 1	0.00 - 600.00	Hz	600.00	●
F15.15	Frequency Hopping Range 1	0.00 - 20.00 Disabled at 0.00	Hz	0.00	●
F15.16	Hopping Frequency Point 2	0.00 - 600.00	Hz	600.00	●
F15.17	Frequency Hopping Range 2	0.00 - 20.00 Disabled at 0.00	Hz	0.00	●
F15.18	Hopping Frequency Point 3	0.00 - 600.00	Hz	600.00	●
F15.19	Frequency Hopping Range 3	0.00 - 20.00 Disabled at 0.00	Hz	0.00	●

Hopping frequency function enables inverter output frequency to avoid mechanical resonance with mechanical load. Inverter is not permitted to run at a constant speed in hopping frequency range, but in acceleration process, there is no hopping and inverter runs smoothly.

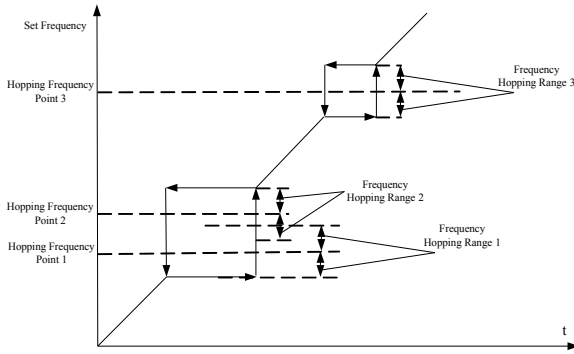

Figure 7-35 Frequency Hopping

As indicated in Figure 7-35, frequency hopping function is set through “Hopping Frequency Point+Frequency Hopping Range”. Specific frequency hopping is: Hopping Frequency Point-Frequency Hopping Range, Hopping Frequency Point+Frequency Hopping Range. Up to three frequency hopping ranges can be set. When their hopping ranges are all set as 0, corresponding frequency function is disabled.

When frequency hopping function is enabled and if set frequency is in frequency hopping range, then finally set frequency will be “Hopping Frequency Point-Frequency Hopping Range” during rising of set frequency or will be “Hopping Frequency Point+Frequency Hopping Range” during decreasing of set frequency.

Different frequency hopping ranges can be superposed (see frequency hopping ranges 1 and 2 in Figure 7-35) and final frequency hopping range is (Hopping Frequency Point 1-Frequency Hopping Range 1, Hopping Frequency Point 2+Frequency Hopping Range 2).

Function Code	Name of Function Code	Parameter Description	Unit	Default	Property
F15.20	FAR Detection Bandwidth	0.00 - 50.00	Hz	2.50	○

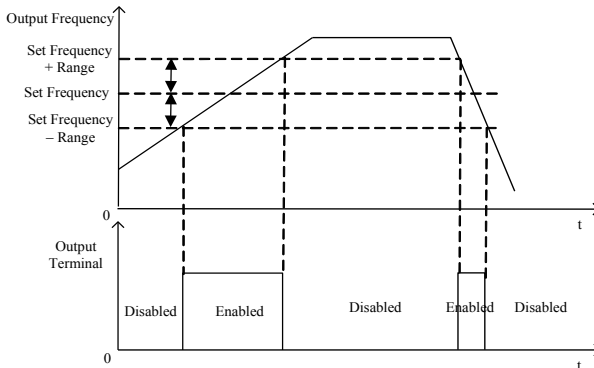

Figure 7-36 FAR Detection

As indicated in Figure 7-36, when multi-function output terminal or relay output is set as “2: FAR”, if absolute value of the difference between output frequency and set input frequency is less than or equal to FAR (F15.20) during inverter running (non-autotuning), multi-function output terminal outputs active level, otherwise multi-function output terminal outputs inactive level.

Function Code	Name of Function Code	Parameter Description	Unit	Default	Property
F15.21	Output Frequency Detection Range FDT1	0.00 - Maximum Frequency F00.16	Hz	30.00	○
F15.22	FDT1 Hysteresis	-(Fmax-F15.21)~F15.21	Hz	2.00	○
F15.23	Output Frequency Detection Range FDT2	0.00 - Maximum Frequency F00.16	Hz	20.00	○
F15.24	FDT2 Hysteresis	-(Fmax-F15.23)~F15.23	Hz	2.00	○

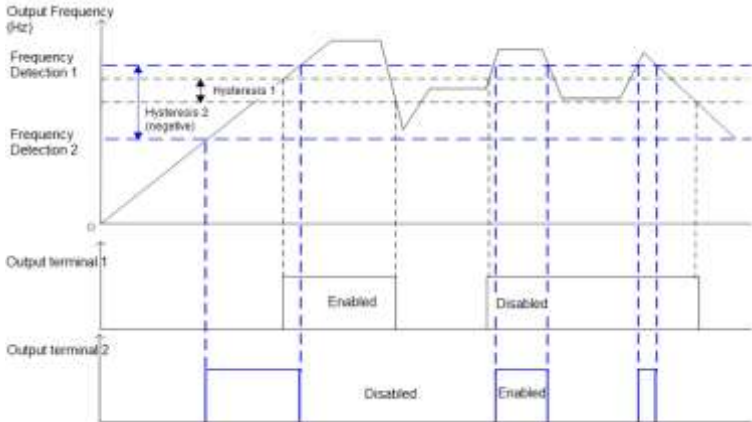

Figure 7-37 FDT Detection

As indicated in Figure 7-37, when multi-function output terminal or relay output is set as “3: Output Frequency Detection Range FDT1” or “4: Output Frequency Detection Range FDT2”, if absolute value of output frequency is greater than output frequency detection range FDT1/2 (F15.21/F15.23), corresponding function terminal outputs active level during inverter running; if absolute value of output frequency drops to a value less than or equal to “Output Frequency Detection Range FDT1/2 (F15.21/F15.23) - FDT1/2 hysteresis”, corresponding function terminal outputs inactive level; if absolute value of output frequency falls between “Output Frequency Detection Range - Hysteresis” and “Output Frequency Detection Range”, output level of corresponding function terminal remains the same.

Function Code	Name of Function Code	Parameter Description	Unit	Default	Property
F15.25	Analog Quantity Level Detection ADT	0: AI1 1: AI2 2: AI3		0	○

Function Code	Name of Function Code	Parameter Description	Unit	Default	Property
		3: AI4 (Expansion Card)			
F15.26	Analog Quantity Level Detection ADT1	0.00 - 100.00	%	20.00	●
F15.27	ADT1 Hysteresis	0.00 - F15.26 (Monotonic decreasing is active)	%	5.00	●
F15.28	Analog Quantity Level Detection ADT2	0.00 - 100.00	%	50.00	●
F15.29	ADT2 Hysteresis	0.00 - F15.28 (Monotonic decreasing is active)	%	5.00	●

Analog quantity level detection can be used to detect and monitor present setting of F15.25 and also for internal operation, external alarm monitoring, etc. Two detection applications can be set, but the detection is only for one analog quantity input channel.

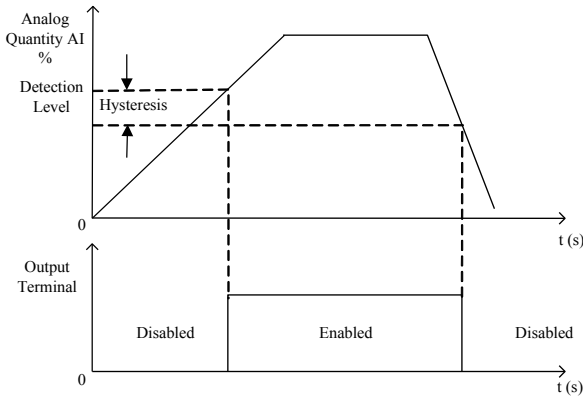

Figure 7-38 ADT Detection

As indicated in Figure 7-38, detection level has been set with a valid start point. When analog quantity of input has been processed for offset and after this, its percentage is greater than detection level, function ADT is enabled; if applications for “disable” are determined by monotonic decreasing hysteresis, when transformation result of input analog quantity is reduced to a value below “Detected Level - Hysteresis”, function ADT is disabled.

Function Code	Name of Function Code	Parameter Description	Unit	Default	Property
F15.30	Energy Consumption Brake	0: Disabled 1: Enabled		0	○
F15.31	Operation Voltage of Energy Consumption Brake	120.0 - 140.0 (380V,100.0=537V)	%	128.5(690V)	●
F15.32	Brake Duty Ratio	20 - 100 (100 means that duty ratio is 1)	%	100	●

Energy consumption brake is a brake method by transforming electric energy generated during speed reduction into heat energy of braking resistor to realize rapid brake. It applies

to brake of large inertia or occasions requiring rapid brake and stop. User needs to choose proper braking resistor and braking unit. See 11.1 Braking Resistor and 11.2 Braking Unit.

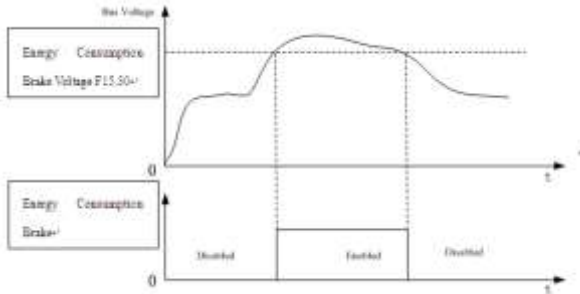

Figure 7-39 Energy Consumption Brake

As indicated in Figure 7-39, when energy consumption brake is enabled (F15.30=1) and bus voltage is greater than operation voltage of energy consumption brake (F15.31), energy consumption brake starts; when bus voltage drops to a value below a certain value, energy consumption brake is disabled.

When inverter is in energy consumption brake, IGBT in braking unit is on and energy can be discharged rapidly through braking resistor. Brake duty ratio (F15.32) describes duty ratio when IGBT is on. The higher duty ratio is, the higher the brake level will be.

Function Code	Name of Function Code	Parameter Description	Unit	Default	Property
F15.33	Control Mode of Set Frequency Lower Than Lower Limit Frequency	0: Run at Lower Limit Frequency 1: Stop		0	○

When set frequency of inverter is lower than lower limit frequency (F00.19), control mode can be set through F15.33.

Function Code	Name of Function Code	Parameter Description	Unit	Default	Property
F15.34	Fan Control	0: Run at Energization 1: Run at Start 2: Run at Intelligent Temperature Control		1	○

Three fan control modes are available to reasonably use fan. It is controlled through F15.34. See Table 7-21 for control modes of fan.

Table 7-21 Fan Running

Fan Control	Description
0: Run at Energization	Fan runs immediately after inverter is powered on.
1: Run at Start	Fan starts running after inverter starts running; fan stops running 1 minute after inverter enters parameter setting status.
2: Run at Intelligent Temperature Control	When inverter temperature > 45℃, fan starts running; when inverter temperature < 40℃, fan stops running; when inverter temperature is not less than 40℃, but not greater than 45℃, fan keeps running.

★ If “2: Run at Intelligent Temperature Control” is selected, make sure that inverter temperature detection module works normally.

Function Code	Name of Function Code	Parameter Description	Unit	Default	Property
F15.35	Overmodulation Intensity	1.00 - 1.10		1.05	●

When input voltage of inverter is lower than output frequency, user can increase overmodulation intensity to enhance utilization factor of bus voltage and increase upper limit of output voltage. If F15.35=1.10, upper voltage limit can be increased by up to 10%, output current at heavy load may be reduced, but current harmonic will go up.

Function Code	Name of Function Code	Parameter Description	Unit	Default	Property
F15.36	PWM Modulation Method Switching Options	0: Disabled (7 preset PWM modulation) 1: Enabled (5 preset PWM modulation)		0	○
F15.37	PWM Modulation Method Switching Frequency	0.00 - Maximum Frequency F00.16	Hz	15.00	●

For PWM modulation method, if F15.36=0, the 7 preset PWM modulation always applies; if F15.36=1, the 7 preset PWM modulation applies when output frequency is lower than switching frequency (F15.37), or the 5 present PWM modulation applies when output frequency is greater than switching frequency, In comparison with the 5 preset PWM modulation mode, current ripple wave for the 7 preset PWM modulation mode is smaller, but switching loss is higher, and inverter would have a higher heating level and a higher temperature rise.

Function Code	Name of Function Code	Parameter Description	Unit	Default	Property
F15.38	Deadband Compensation Mode	0: Disabled 1: Compensation Mode 1 2: Compensation Mode 2		1	○

User does not need to change the option of this function code. Only when there are special requirements on output voltage waveform quality or motor is in an abnormal status (for example oscillation) will user try to select a different compensation mode.

Generally, compensation mode 1 is selected, but user may select compensation mode 2 in case of high power and VF control, which can easily cause motor oscillation.

Function Code	Name of Function Code	Parameter Description	Unit	Default	Property
F15.39	Terminal Jog Priority	0: Disabled 1: Enabled		0	○

When inverter is in terminal control mode (F00.02=1), this function code is used to select whether JOG command has top priority. For terminal jog priority (F15.39=1), inverter changes to jog running status after jog terminal is enabled, even if inverter is running; if F15.39=0, inverter can not change to jog running status from running status directly.

Function Code	Name of Function Code	Parameter Description	Unit	Default	Property
F15.40	Deceleration Time at Rapid Stop	0.00 - 650.00 (F15.13=0) 0.0 - 6500.0 (F15.13=1) 0 - 65000 (F15.13=2)	s	1.00	●

This function code refers to setting of acceleration/deceleration time while inverter is in “rapid stop”.

7.17 F16 Group: User Defined Function Parameter

Function Code	Name of Function Code	Parameter Description	Unit	Default	Property
F16.01	Set Length	1-65535 (F16.13=0) 0. 1-6553.5 (F16.13=1) 0.01-655.35 (F16.13=2) 0.001-65.535 (F16.13=3)	m	1000	●
F16.02	Pulse Count Per Meter	0.1 - 6553.5		100.0	●
F16.03	Set Count Value	F16.04 - 65535		1000	●

EM600 inverter has the fixed length count function (refer to Figure 7-40). Inverter must input length information via numeric input terminal in the form of pulse before setting relevant function codes to complete length count function. Completion information of final length count can be outputted via numeric output terminal and other methods for other purposes (for example, input it via DI/VX to be used as stop command). User may also view present length count value through F18.34.

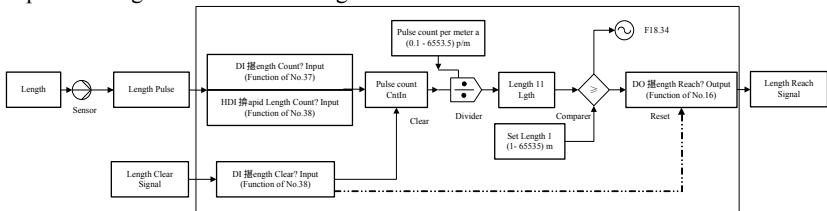

Figure 7-40 Block Diagram of Fix Length Count Function

Principle of work: Length detection sensor transforms length information into pulse information; DI terminal collects input pulse number N; according to setting of “Pulse

Count per Meter” as α , we can know that length is $l_1 = \frac{N}{\alpha}$, and then compare it with

“Set Length” l . If $l_1 < l$, it means that length has not reached set value; otherwise, this function is completed. “39: Length Clear” is used to clear count and reset output signal. If pulse frequency is greater than 250 Hz ($=1/(2(\text{default filter times}) * 2 * 1\text{ms}^{-1})$), please complete input via X7 and set F02.06 as “38: High-Speed Length Count Input”. 250 Hz is just a theoretical value. Actual value will apply. To avoid any mistake, please use high speed pulse input terminal.

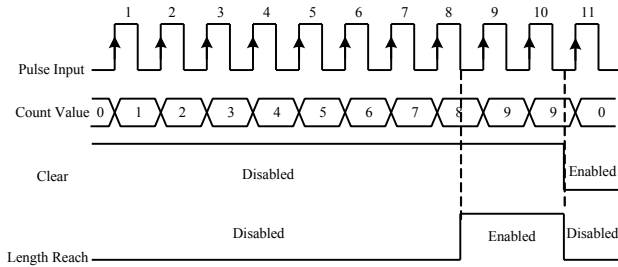

Figure 7-41 Fixed Length Count (Example)

Figure 7-41 shows an example, in which F16.01=2 and F16.02=4.0. When length count reaches 8(=2×4), “16: Length Reach” is enabled; when “39: Length Clear” is enabled, the count will be cleared and “16: Length Reach” output is disabled.

Function Code	Name of Function Code	Parameter Description	Unit	Default	Property
F16.03	Set Count Value	F16.04 - 65535		1000	●
F16.04	Designated Count Value	1 - F16.03		1000	●

EM600 inverter supports count function (refer to Figure 7-42). Pulse information is inputted via numeric input terminal. When count reaches set value, corresponding signal will be outputted. User can perform programming with this signal (for example input it via DI/VX to be used as stop command). User can view present count value via F18.33 in real time.

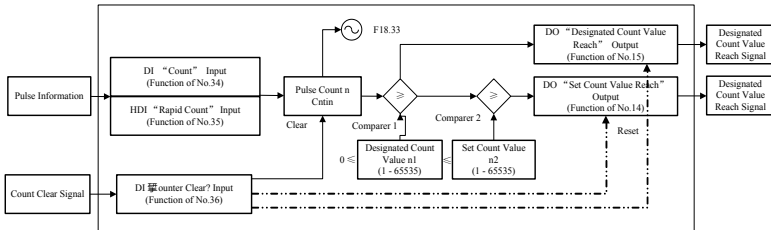

Figure 7-42 Block Diagram of Count Function

Principle of work: When certain information is inputted in the form of pulse. DI terminal collects the information about input pulse number n , and then compare it with the “Designated Count Value” n_1 . If $n < n_1$, it means that “Set Count Value” has not been reached, otherwise it finishes and this result is outputted in the form of terminal DO.

Continue count and compare it with “Set Count Value” n_2 . If $n < n_2$, it means that “Set Count Value” has not been reached, otherwise it finishes and this result is outputted in the form of terminal DO with count stopping. “36: Counter Clear” is used to clear counter and reset output signal.

If pulse frequency is greater than 250 Hz (=1/(2(default filter times)*2*1ms⁻¹)), please complete input via X7 and set F02.06 as “35: High-Speed Count Input”. 250 Hz is just a theoretical value. Actual value will apply. To avoid any mistake, please use high speed pulse input terminal.

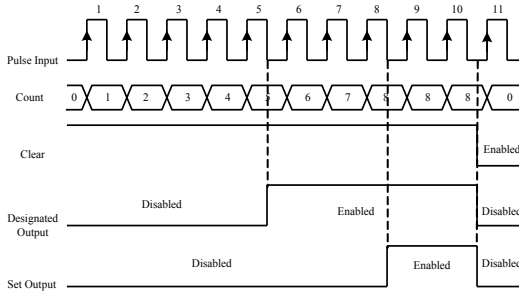



Figure 7-43 Count (Example)

Figure 7-43 shows an example, in which F16.03=8 and F16.04=5. When count reaches 5, “15: Designated Count Value Reach” is enabled; when count reaches 8, “14: Set Count Value Reach” is enabled; when “36: Counter Clear” is enabled, count will be cleared and both “15: Designated Count Value Reach” and “14: Set Count Value Reach” are disabled.

 Set $65535 \geq \text{Set Count Value} \geq \text{Designated Count Value} \geq 0$; if set count value = designated count value=0, then the counter is disabled; only one terminal can be set with this function for the same time.

Function Code	Name of Function Code	Parameter Description	Unit	Default	Property
F16.05	Set Timed Run Time	0.0 - 6500.0 Disabled at 0.0	min	0.0	●

This function code shall not be set as 0 to start timed run function. When running time reaches set value, inverter stops and output terminal of the function “26: Set Time Reach” is enabled, with a prompt for the reach to running time.

User can view remaining time through F18.35 or clear preset running time by input function “27: Clear Timed Run Time” (i.e., reset F18.35). When inverter is not running, this time indicates set time; when inverter is running, this time refers to remaining time. That is to say, timed run procedure starts from inverter running. After inverter stops, accumulated time is cleared.

Function Code	Name of Function Code	Parameter Description	Unit	Default	Property
F16.06	Agent Password	0 - 65535		0	○

Agent Password

★: By setting this password, inverter can not be used normally. Please pay enough attention.

Function Code	Name of Function Code	Parameter Description	Unit	Default	Property
F16.07	Set Accumulated Power-On Time Reach	0 - 65535, 0: Power-on Reach Time Protection Disabled	h	0	○

These codes are used to set accumulated power-on reach time. When accumulated power-on time (F12.15) is equal to or greater than accumulated power-on reach time (F16.07), inverter can not be used.

★ By setting this parameter, inverter can not be used normally. Please pay enough attention.

Function Code	Name of Function Code	Parameter Description	Unit	Default	Property
F16.08	Set Accumulated Run Time Reach	0 - 65535, 0: Run Time Reach Protection Disabled	h	0	○

This function is used to set accumulated run reach time. When accumulated run time (F12.17) is equal to or greater than set accumulated run reach time (F16.08), inverter can not be used.

★ By setting this parameter, inverter can not be used normally. Please pay enough attention.

Function Code	Name of Function Code	Parameter Description	Unit	Default	Property
F16.09	Factory Password	0 - 65535		XXXXXX	●

Factory Password

★ By setting this password, inverter can not be used normally. Please pay enough attention.

7.18 F17 Group: Virtual I/O Function Parameter

EM600 inverter has 8 multi-function virtual input terminals (VX1 - VX8). Their functions and use methods are basically the same as actual input terminals. In the following, only the difference will be described. For the same functions and use methods as that of actual input terminals, please refer to F02 Input Terminal Function Parameters.

Function Code	Name of Function Code	Parameter Description	Unit	Default	Property																
F17.00	VX1 Virtual Input Function	Same as options of F02 group numeric input terminals, please refer to Table 7-2 Functions of Numeric Multi-Function Input Terminals		0	○																
F17.01	VX2 Virtual Input Function			0	○																
F17.02	VX3 Virtual Input Function			0	○																
F17.03	VX4 Virtual Input Function			0	○																
F17.04	VX5 Virtual Input Function			0	○																
F17.05	VX6 Virtual Input Function			0	○																
F17.06	VX7 Virtual Input Function			0	○																
F17.07	VX8 Virtual Input Function			0	○																
F17.08	Positive/Negative Logic of Virtual Input	<table border="1" style="width: 100%; border-collapse: collapse;"> <tr> <td>D7</td><td>D6</td><td>D5</td><td>D4</td><td>D3</td><td>D2</td><td>D1</td><td>D0</td> </tr> <tr> <td>VX8</td><td>VX7</td><td>VX6</td><td>VX5</td><td>VX4</td><td>VX3</td><td>VX2</td><td>VX1</td> </tr> </table> 0: Positive Logic, Enabled at On/Disabled at Off	D7	D6	D5	D4	D3	D2	D1	D0	VX8	VX7	VX6	VX5	VX4	VX3	VX2	VX1		000 00000	○
D7	D6	D5	D4	D3	D2	D1	D0														
VX8	VX7	VX6	VX5	VX4	VX3	VX2	VX1														

Function Code	Name of Function Code	Parameter Description	Unit	Default	Property
		1: Negative Logic, Disabled at On/Enabled at Off			
F17.11	VX1 Effective Delay Time	0.000 - 30.000	s	0.000	●
F17.12	VX1 Ineffective Delay Time	0.000 - 30.000	s	0.000	●
F17.13	VX2 Effective Delay Time	0.000 - 30.000	s	0.000	●
F17.14	VX2 Ineffective Delay Time	0.000 - 30.000	s	0.000	●
F17.15	VX3 Effective Delay Time	0.000 - 30.000	s	0.000	●
F17.16	VX3 Ineffective Delay Time	0.000 - 30.000	s	0.000	●
F17.17	VX4 Effective Delay Time	0.000 - 30.000	s	0.000	●
F17.18	VX4 Ineffective Delay Time	0.000 - 30.000	s	0.000	●

In terms of functions, VX1 - VX8 are basically the same; they do not have an actual physical terminal, but they all have positive/negative logic function. VX1 - VX4 have delay function, with the same terminal status confirmation method; they can be set respectively. An example is given to VX1 in the following part.

Function Code	Name of Function Code	Parameter Description								Unit	Default	Property
F17.09	VX1 - VX8 Status Setting	D7	D6	D5	D4	D3	D2	D1	D0		000 00000	○
		VX8	VX7	VX6	VX5	VX4	VX3	VX2	VX1			
0: VXn Is Same as VYn Output 1: Status to be Set by F17.10												
F17.10	VX1 - VX8 Status Setting	D7	D6	D5	D4	D3	D2	D1	D0		000 00000	●
		VX8	VX7	VX6	VX5	VX4	VX3	VX2	VX1			
0: Disabled 1: Enabled												

- If F17.09=xxxxxxx0, VX1 status and VY1 output status are the same. As mentioned above, virtual input terminal has the same status as virtual output terminal. At this time, it needs to be used together with virtual output terminal. If F17.19=16 and F17.28=xxxx xxx1 (VY1 output status is determined by output function status) under default applications, then when “16: Length Reach” is enabled, VY1 is enabled and VX1 is enabled as well; at this time, setting this function as per VX1 (assuming 39: Length Clear) to complete corresponding operations (clear length count and reset VY1). Now, fixed length count function can start again to realize the repeated processing requirements. If time interval is needed for repeated processing times, we can realize this function by VX1 delay.
- If F17.09=xxxxxxx1, VX1 status of is determined by bit0 of function code F17.10. Status of virtual input terminals can be set by function codes. This method is mainly used

for remote control of host controller. Remote control terminal may use function code 0x41 to change status setting of F17.10 (enabled or disabled) via communication. EM600 inverter has 8 multi-function virtual output terminals (VY1 - VY8). Their functions and use methods are basically the same as actual output terminals. In the following, only the difference will be described. For the same functions and use methods as that of actual input terminals, please refer to F03 Output Terminal Function Parameter.

Function Code	Name of Function Code	Parameter Description	Unit	Default	Property
F17.19	VY1 Virtual Output Function	Same as options of F03 group numeric output terminals, please refer to Table 7-6 Numeric Multi-Function Output Terminals		0	○
F17.20	VY2 Virtual Output Function			0	○
F17.21	VY3 Virtual Output Function			0	○
F17.22	VY4 Virtual Output Function			0	○
F17.23	VY5 Virtual Output Function			0	○
F17.24	VY6 Virtual Output Function			0	○
F17.25	VY7 Virtual Output Function			0	○
F17.26	VY8 Virtual Output Function			0	○
F17.27	Positive/Negative Logic of Virtual Input	D7 D6 D5 D4 D3 D2 D1 D0 VY8 VY7 VY6 VY5 VY4 VY3 VY2 VY1		000 00000	○
		0: Positive Logic, Enabled at On/Disabled at Off 1: Negative Logic, Disabled at On/Enabled at Off			
F17.29	VY1 Effective Delay Time	0.000 - 30.000	s	0.000	●
F17.30	VY1 Ineffective Delay Time	0.000 - 30.000	s	0.000	●
F17.31	VY2 Effective Delay Time	0.000 - 30.000	s	0.000	●
F17.32	VY2 Ineffective Delay Time	0.000 - 30.000	s	0.000	●
F17.33	VY3 Effective Delay Time	0.000 - 30.000	s	0.000	●
F17.34	VY3 Ineffective Delay Time	0.000 - 30.000	s	0.000	●
F17.35	VY4 Effective Delay Time	0.000 - 30.000	s	0.000	●
F17.36	VY4 Ineffective Delay Time	0.000 - 30.000	s	0.000	●

In terms of functions, VY1 - VY8 are basically the same; they do not have an actual

physical terminal, but they all have positive/negative logic function. VY1 - VY4 have delay function, with the same terminal status confirmation method; they can be set respectively. An example is given to VY1 in the following part.

Function Code	Name of Function Code	Parameter Description								Unit	Default	Property
		D7	D6	D5	D4	D3	D2	D1	D0			
F17.28	Virtual Output Terminal Control	VY8	VY7	VY6	VY5	VY4	VY3	VY2	VY1		000 00000	○
		0: To be determined by status of X1 – X7. 1: To be determined by output function status.										

- If F17.28=xxxxxxx0, VY1 status and X1 input status are the same. Status of VY1 is synchronized with actual input status X1. This application can be used for status confirmation and one switch motion can be used for realizing programming of multiple functions, etc.
- If F17.28=xxxxxxx1, status of VY1 is determined by F17.19. Status of virtual output terminal is determined by set status. Such output is mainly used for soft programming. For example, we can output signal of “19: PID Feedback Upper Limit Reach” via VY1 (F17.19=19), and collect the signal via VX1 (F17.00=41), in order to control PID via function code “PID Feedback Upper Limit Reach”.

Function Code	Name of Function Code	Parameter Description							Unit	Default	Property	
		VX8	VX7	VX6	VX5	VX4	VX3	VX2				VX1
F17.37	Virtual Input Terminal Status	VX8	VX7	VX6	VX5	VX4	VX3	VX2	VX1		000 00000	×
		0: Disabled 1: Enabled										
F17.38	Virtual Output Terminal Status	VY8	VY7	VY6	VY5	VY4	VY3	VY2	VY1		000 00000	×
		0: Disabled 1: Enabled										

These function codes are used to display present virtual terminal status in real time.

7.19 F18 Group: Monitoring Parameter

This group of parameters can be used for viewing present status of inverter, but can not be used to operate them.

Function Code	Name of Function Code	Parameter Description	Unit
F18.00	Output Frequency	Display present output frequency. Range: 0.00 - Upper Limit Frequency ★ This parameter will be updated in real time only when inverter is in speed control mode.	Hz
F18.01	Set Frequency	Display present set frequency. Range: 0.00 - Maximum Frequency F00.16 ★ This parameter will be updated in real time only when inverter is in speed control mode.	Hz

Function Code	Name of Function Code	Parameter Description	Unit
F18.02	PG Feedback Frequency	This function is used to display PG feedback frequency, when inverter is under FVC control mode or other control modes with the feedback encoder. Range: 0.00 – Upper Limit Frequency. ★ This parameter will be updated only when a PG card is equipped.	Hz
F18.03	Estimated Feedback Frequency	Used to display estimated feedback frequency when inverter is in SVC control. Range: 0.00 - Upper Limit Frequency. ★ This parameter will be updated in real time only when inverter is in SVC control.	Hz
F18.04	Output Torque	Display present output torque of inverter. Range: -200.0 - 200.0.	%
F18.05	Torque Setting	Display present set torque of inverter. Range: -200.0 - 200.0. ★ This parameter will be updated in real time only when inverter is under torque control mode.	%
F18.06	Output Current	Display present output current of inverter. According to motor rated power ratings: 0.00 - 650.00 (Motor Rated Power ≤ 75kW) 0.0 - 6500.0 (Motor Rated Power >75kW)	A
F18.07	Output Current Percentage	Display present output current in the form of percentage (relative to inverter rated current). Range: 0.0 - 300.0.	%
F18.08	Output Voltage	Display present output voltage. Range: 0.0 - 690.0.	V
F18.09	DC Bus Voltage	Display present bus voltage. Range: 0 - 1200.	V
F18.10	Simple PLC Running Times	When auxiliary frequency source B is involved in setting (F00.06≠0), by setting “11: Simple PLC” (F00.05=11) and simple PLC running mode is “Limited Times of Cycles” (F08.15=1/2), inverter will display present running times; “0” means that it is the first time, “1” means that it has finished the first time and is running for the second time, and so on. Range: 0 - F08.16.	
F18.11	Simple PLC Running Stage	When auxiliary frequency source B is involved in setting (F00.06≠0), by setting “11: Simple PLC” (F00.05=11), inverter will display present running PLC running stage. Range: 1-15, which correspond to preset speed 1 (F08.00)–15 (F08.14) respectively.	
F18.12	PLC Running Time of Present Stage	When auxiliary frequency source B is involved in setting (F00.06≠0), by setting “11: Simple PLC” (F00.05=11), inverter will display present running PLC running stage. Range: 0.0 – Corresponding Time Setting (for example time of preset speed is determined by F08.20).	s/min
F18.13	Not Used		
F18.14	Load Speed	Display present load speed. For normal display, please set	rpm

Function Code	Name of Function Code	Parameter Description	Unit										
		load speed display factor (F12.09). Range: 0 - 65535.											
F18.15	UP/DOWN Offset Frequency	Used to display UP/DOWN offset frequency. For details, please refer to description of UP/DOWN Function of F12.10 - F12.12. ★ When inverter is running, this value will be displayed for about 1s by pressing UP or DOWN.	Hz										
F18.16	PID Setting	Used to display present PID setting; divide it by F09.03 to get present percentage setting.											
F18.17	PID Feedback	Used to display present PID feedback; divide it by F09.03 to get present percentage setting.											
F18.18	Kilowatt-Hour Meter, MWh	Used to display accumulated input (output + fan) energy consumption (MWh). Used together with F18.19 to confirm present energy consumption.	MWh										
F18.19	Kilowatt-Hour Meter, kWh	Used to display accumulated input (output + fan) energy consumption (MWh). Used together with F18.18 to confirm present energy consumption.	kWh										
F18.20	Output Power	Display present output power. Range: 0.00 - 650.00.	kW										
F18.21	Output Power Factor	Display present output power factor. Range: -1.00 - 1.00.											
F18.22	Numeric Input Terminal Status 1	Display present active status of input terminals X1 - X5. The five-digit nixie tube will display the following information from left to right: <table border="1" style="width: 100%; text-align: center;"> <tr> <td>X5</td> <td>X4</td> <td>X3</td> <td>X2</td> <td>X1</td> </tr> <tr> <td>0/1</td> <td>0/1</td> <td>0/1</td> <td>0/1</td> <td>0/1</td> </tr> </table> Actual display: 00001 ★ 0: disabled; 1: enabled.	X5	X4	X3	X2	X1	0/1	0/1	0/1	0/1	0/1	
X5	X4	X3	X2	X1									
0/1	0/1	0/1	0/1	0/1									
F18.23	Numeric Input Terminal Status 2	Display present active status of input terminals X6/X7/AI1 - AI3. The five-digit nixie tube will display the following information from left to right: <table border="1" style="width: 100%; text-align: center;"> <tr> <td>AI3</td> <td>AI2</td> <td>AI1</td> <td>X□</td> <td>X6</td> </tr> <tr> <td>0/1</td> <td>0/1</td> <td>0/1</td> <td>01</td> <td>□□1</td> </tr> </table> Actual display: 00000 ★ For EM600 inverter, analog input terminals AI1 - AI3 can be used for numeric input only. ★ 0: Disabled; 1: Enabled.	AI3	AI2	AI1	X□	X6	0/1	0/1	0/1	01	□□1	
AI3	AI2	AI1	X□	X6									
0/1	0/1	0/1	01	□□1									
F18.24	Numeric Input Terminal Status 3	Display present active status of input terminals X8 - X11/AI4. The five-digit nixie tube will display the following information from left to right: <table border="1" style="width: 100%; text-align: center;"> <tr> <td>AI4</td> <td>X11</td> <td>X10</td> <td>X9</td> <td>X8</td> </tr> <tr> <td>0/1</td> <td>0/1</td> <td>0/1</td> <td>0/1</td> <td>0/1</td> </tr> </table> Actual display: 00000 ★ Display terminals for this function code are all expansion card (EC-IO-A1) terminals. Please perform configuration before use.	AI4	X11	X10	X9	X8	0/1	0/1	0/1	0/1	0/1	
AI4	X11	X10	X9	X8									
0/1	0/1	0/1	0/1	0/1									

Function Code	Name of Function Code	Parameter Description	Unit										
		★ 0: disabled; 1: enabled.											
F18.25	Output Terminal Status	Display present active status of input terminals R1/R2/Y1/Y2. The five-digit nixie tube will display the following information from left to right: Actual display: 01010.											
		<table border="1"> <tr> <td>Y3</td> <td>R2</td> <td>□1</td> <td>Y2</td> <td>Y1</td> </tr> <tr> <td>0/1</td> <td>0/1</td> <td>0/1</td> <td>0/1</td> <td>0/1</td> </tr> </table>	Y3	R2	□1	Y2	Y1	0/1	0/1	0/1	0/1	0/1	
		Y3	R2	□1	Y2	Y1							
0/1	0/1	0/1	0/1	0/1									
★ Numeric output terminal Y3 is an expansion card (EC-IO-A1) terminal. Please perform configuration before use. ★ 0: disabled; 1: enabled.													
F18.26	AI1	Used to display standard value of present analog input channel 1 (AI1) corresponding to 100.0%. Range: 0.0 - 100.0.	%										
F18.27	AI2	Used to display standard value of present analog input channel 2 (AI2) corresponding to 100.0%. Range: 0.0 - 100.0.	%										
F18.28	AI3	Used to display standard value of present analog input channel 3 (AI3) corresponding to 100.0%. Range: 0.0 - 100.0.	%										
F18.29	AI4	Used to display standard value of present analog input channel 4 (AI4) corresponding to 100.0%. Range: -100.0 - 100.0. ★ Analog input terminal AI4 is an expansion card (EC-IO-A1) terminal. Please perform configuration before use.	%										
F18.30	Communication Setting	Not used	%										
F18.31	High-Speed Pulse Input Frequency: kHz	Used to display input pulse frequency of present high-speed pulse input channel HDI (X7). Minimum resolution: 0.01 kHz. Range: 0.00 - 100.00.	kHz										
F18.32	High-Speed Pulse Input Frequency: Hz	Used to display input pulse frequency of present high-speed pulse input channel HDI (X7). Minimum resolution: 1 kHz. Range: 0 - 65535. If actual input frequency > 65535 Hz, display value is 65535.	Hz										
F18.33	Count Value	Used to display number of input pulses of present high-speed pulse input channel HDI (X7). See F16.03 and F16.04. Range: 0 - F16.03.											
F18.34	Actual Length	Used to display actual length of workpiece being processed (by transformation from HDI (X7) as per relevant setting) of input pulses of present high-speed pulse input channel HDI (X7). See F16.03 and F16.04. Range: 0 - F16.01.	m										
F18.35	Remaining Time of Timed Run	Used to display remaining time of timed run. See F16.05. Range: 0.0 - F16.05.	min										

Function Code	Name of Function Code	Parameter Description	Unit
F18.36	Position of Rotor of Synchronous Motor	Position of rotor of synchronous motor. Range: 0.0 - 359.9.	°
F18.37	Rotary Transformer Position	Used to display rotary transformer position. Range: 0 - 4095.	
F18.38	Motor Temperature	Used to display motor temperature collected by analog channel 4 (AI4). Range 0 – 200.	°C
F18.39	VF Separation Target Voltage	Used to display VF separation target voltage in real time. Range: 0.0 - Motor Rated Voltage.	V
F18.40	VF Separation Output Voltage	Used to display VF separation output voltage in real time. Range: 0.0 - Motor Rated Voltage.	V
F18.41 - F18.42	Not Used	-	-
F18.43	Zero Servo Position Offset	0 - 65535	
F18.44 - F18.50	Not Used	-	-
F18.51	PID Output	Process PID is running, display the PID output value (%)	%
F18.52	Spindle Orientation Setting Position	Display the setting position on spindle orientation	
F18.53	Spindle Orientation Current Position	Display the current position on spindle orientation	
F18.54	Feed Setting High Byte	Display the feed setting value of high Byte on spindle orientation	
F18.55	Feed Setting Low Byte	Display the feed setting value of low Byte on spindle orientation	
F18.56	Feed Current High Byte	Display the feed current value of high Byte on spindle orientation	
F18.57	Feed Current Low Byte	Display the feed current value of low Byte on spindle orientation	
F18.58	Feedback Pulse High Byte	Display the encoder feedback pulse value of high byte (HEX)	
F18.59	Feedback Pulse Low Byte	Display the encoder feedback pulse value of low byte (HEX)	

7.20 F19 Group: Fault Record Parameter

This group of parameters can be used for viewing types of last three faults and status of inverter at fault, but can not be operated.

- Function codes related to the information about last fault:

Function Code	Name of Function Code	Parameter Description	Unit	Default	Property
F19.00	Last Fault Type	Display last fault type. See chapter 9.		0	×
F19.01	Output Frequency at Fault	Used to display output frequency at last fault.	Hz	0.00	×
F19.02	Output Current at Fault	Used to display output current at last fault.	A	0.00/0.0	×
F19.03	Bus Voltage at Fault	Used to display bus voltage at last fault.	V	0	×
F19.04	Running Mode at Fault	Used to display running status at last fault. See chapter 9.		0	×
F19.05	Working Time at Fault	Used to display working time at last fault.	h	0	×

- Function codes related to the information about last fault:

Function Code	Name of Function Code	Parameter Description	Unit	Default	Property
F19.06	Last Fault Type	Display last fault type. See chapter 9.		0	×
F19.07	Output Frequency at Fault	Display output frequency at last fault.	Hz	0.00	×
F19.08	Output Current at Fault	Display output current at last fault.	A	0.00/0.0	×
F19.09	Bus Voltage at Fault	Display bus voltage at last fault.	V	0	×
F19.10	Running Mode at Fault	Used to display running status at last fault. See chapter 9.		0	×
F19.11	Working Time at Fault	Used to display working time at last fault.	h	0	×

- Function codes related to the information about last two faults:

Function Code	Name of Function Code	Parameter Description	Unit	Default	Property
F19.12	Types of Last Two Faults	Display types of last two faults. See chapter 9.		0	×
F19.13	Output Frequency at Fault	Display output frequency at last two faults.	Hz	0.00	×
F19.14	Output Current at Fault	Display output current at last two faults.	A	0.00 /0.0	×
F19.15	Bus Voltage at Fault	Display bus voltage values at last two faults.	V	0	×

F19.16	Running Mode at Fault	Used to display running status at last two faults. See Table 7-22 fault types.		0	×
F19.17	Working Time at Fault	Used to display working time at last two faults.	h	0	×

For various fault types of EM600 please see chapter 9.

For running modes of EM600 at fault, see Table 7-22:

Table 7-23 Running Modes at Fault

Keypad display	Running Mode
0	Not Running
1	Forward Acceleration
2	Reverse Acceleration
3	Forward Deceleration
4	Reverse Deceleration
5	Forward Constant Speed
6	Reverse Constant Speed

8 Motor Parameter Autotuning

8.1 Motor Parameter Autotuning

When inverter is in vector control, motor parameter autotuning is required. However, if not, parameter autotuning is also suggested for acquiring higher control precision at initial operation.

EM600 provides the function of motor parameter autotuning. After the function is enabled, inverter autotunes connected motor parameters and saves parameter values to internal memory. For definitions of motor parameters, please refer to Figure 8-1 for 3-phase induction motor parameters.

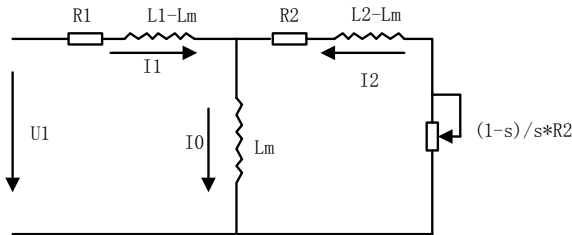

Figure 8-1 Equivalent Circuit of 3-Phase Induction Motor

In the figure, meanings of $R1$, $R2$, $L1$, $L2$, Lm and $I0$: Stator resistor, rotor resistor, stator inductance, rotor inductance, stator & rotor mutual inductance, and idling excitation current respectively; leakage inductance $Ls=L-Lm$.

8.2 Precautions Before Autotuning

- Autotuning is a process of autotuning motor parameters. EM600 can autotune motor parameters in 2 modes: stationary autotuning and rotational autotuning.
 - Stationary autotuning is applied to the occasions when motor can not be disconnected from load, but inverter can obtain motor parameters.
 - Rotational autotuning is applied to the occasions when motor can be disconnected from load. Before autotuning, motor shall be disconnected from load. Never perform rotational autotuning for a motor with load.
- Make sure that motor is in stop status before autotuning; otherwise, autotuning can not be performed normally.
- Autotuning is only enabled when inverter is in keypad control mode (F00.02=0) .
- To ensure normal autotuning, set all motor parameters as per values listed on motor nameplate correctly: for open loop control F01.00: Motor model, F01.01: Motor rated power, F01.02: Motor rated voltage, F01.03: Motor rated current, F01.04: Motor rated frequency, F01.05: Motor rated speed, F01.06: Motor wiring method and F01.07: Motor rated power factor. For closed loop control extra parameters should be set: F01.24 (Encoder Type) and F01.25 (Encoder Resolution). Based on rated power of inverter, match inverter with applicable Y-series motor, and defaults of motor can meet most of needs.
- To ensure control performance, motor and inverter shall match in terms of power rating. Usually, power rating of motor is only allowed to be one level lower than that of inverter.
- After autotuning finishes normally, setting values of F01.09 - F01.13 and F01.19 -



F01.22 will be updated and auto-saved.

- When F12.14=1 reset defaults, parameters of F01.00 - F01.13 and F01.19 – F01.22 remain unchanged.







8.3 Steps of Autotuning

- In parameter setting status, set F00.2=0, and disconnect motor from load.
- Set all motor parameters as per values listed on nameplate correctly: F01.00: Motor model, F01.01: Motor rated power, F01.02: Motor rated voltage, F01.03: Motor rated current, F01.04: Motor rated frequency, F01.05: Motor rated speed, F01.06: Motor wiring method and F01.07: Motor rated power factor.

Asynchronous motor autotuning

- By setting F01.34=1, and pressing , inverter starts stationary autotuning for motor.
Or by setting F01.34=2, and pressing , inverter starts rotational autotuning for motor.

Synchronous motor autotuning

- By setting F01.34=11, and pressing , inverter starts stationary autotuning for motor.
- Or by setting F01.34=12, and pressing , inverter starts rotational autotuning for motor.
- Or by setting F01.34=13, and pressing , inverter starts rotational autotuning for motor's encoder.
- It takes about 2 minutes to complete autotuning and, afterwards, keypad returns to initial power-on status.
- By pressing  in autotuning, it will display “E24” parameter autotuning fault. By pressing , inverter will return to parameter setting status.
- If autotuning fails, inverter will display “E24” parameter autotuning fault. By pressing , inverter will return to parameter setting status.

9 Troubleshooting

9.1 Faults

When something abnormal happens to inverter, keypad will display corresponding fault code and parameter; the fault relay is on, the fault output terminal is on, inverter output stops. If motor is still running when a fault occurs, it will ramp to stop or coast to stop. For EM600 faults and countermeasures, see Table 9-1.

Table 9-1 EM600 Faults and Troubleshooting

Fault Code	Fault type	Cause	Troubleshooting
<i>SC</i>	Short Circuit/EMC Fault	<ol style="list-style-type: none"> 1. Short circuit between output phase and ground 2. Short circuit between phases 3. Short circuit of external brake resistor 4. Acceleration/deceleration time is too short 5. Power module is damaged 6. Field interference 	<ol style="list-style-type: none"> 1. Check if there is any short circuit phenomenon in wiring. 2. Extend acceleration/deceleration time. Investigate causes and reset after taking appropriate measures. 3. Seek for technical support.
<i>HOC</i>	Instantaneous Overcurrent	<ol style="list-style-type: none"> 1. Short circuit between inverter output phases, or between output phase and ground. 2. Acceleration/deceleration time is too short. 3. Under V/F control mode, V/F curve has been set irrationally. 	<ol style="list-style-type: none"> 1. Check if there is any short circuit phenomenon in wiring. 2. Extend acceleration/deceleration time. 3. Set V/F curve rationally.
<i>SOC</i>	Stable Overcurrent	<ol style="list-style-type: none"> 4. Motor is running when inverter starts. 4. Motor exceeds inverter capacity or load is too heavy. 5. IGBT damaged (HOC). 	<ol style="list-style-type: none"> 4. Enable revolution track or start DC brake. 5. Replace with appropriate motor or inverter.
<i>HOU</i>	Instantaneous Overvoltage	<ol style="list-style-type: none"> 1. Deceleration time is too short and regenerated energy is too large. 	<ol style="list-style-type: none"> 1. Extend deceleration time. 2. Select appropriate braking unit/braking resistor.
<i>SOU</i>	Stable Overvoltage	<ol style="list-style-type: none"> 2. Input voltage is too high. 	<ol style="list-style-type: none"> 3. Lower input voltage to the specified range.
<i>SLU</i>	Stable Undervoltage	<ol style="list-style-type: none"> 1. Input voltage phase loss. 2. Wiring terminals of input voltage are loosened. 3. Input voltage drops too much.. 4. Aging of switch contact on input power supply. 	<ol style="list-style-type: none"> 1. Check input voltage and its wiring. 2. Tighten screws of input wiring terminal. 3. Check air switch and contactor.
<i>ILP</i>	Input Phase Loss	<ol style="list-style-type: none"> 1. Input voltage phase loss. 	<ol style="list-style-type: none"> 1. Check input voltage. 2. Check input voltage wiring.

Fault Code	Fault type	Cause	Troubleshooting
			3. Check whether connection terminals are loosened.
<i>DLP</i>	Output Phase Loss	1. Phase loss of U, V and W.	1. Check connection between inverter and motor. 2. Check whether motor winding is disconnected; 3. Check whether output terminals are loosened.
<i>OL</i>	Inverter Overload	1. Acceleration/deceleration time is too short. 2. Under V/F control mode, V/F curve has been set irrationally. 3. Load is too heavy.	1. Extend acceleration/deceleration time. 2. Set V/F curve rationally. 3. Replace inverter with another one that matches with load.
<i>OH</i>	Radiator overheating	1. Ambient temperature is too high. 2. Inverter is in poor ventilation. 3. Cooling fan fault.	1. Running applications of inverter shall comply with specification requirements. 2. Improve ventilation environment and check whether air duct is blocked. 3. Replace cooling fan.
<i>E 11</i>	Parameter Setting Conflict	1. Parameter setting logic conflict.	1. Check whether parameters set prior to fault are unreasonable.
<i>E 12</i>	Motor Overheating	1. Detection of motor temperature is greater than the threshold 2. Motor temperature sensor is broken. 3. Ambient temperature is too high 4. The load is too heavy	1. Check motor temperature threshold. 2. Check motor temperature sensor 3. Improve heat dissipation of the motor 4. Choose the proper motor
<i>E 13</i>	Motor Overload	1. Acceleration/deceleration time is too short. 2. Under V/F control mode, V/F curve has been set irrationally. 3. Load is too heavy.	1. Extend acceleration/deceleration time. 2. Set V/F curve rationally. 3. Replace proper motor matching load.
<i>E 14</i>	External Fault	1. Peripheral fault terminal acts.	1. Check peripherals.
<i>E 15</i>	Inverter EEPROM Fault	1. Interference results in reading and writing errors of EEPROM. 2. EEPROM damaged.	1. Press STOP/RESET to reset and then try it again. 2. Seek for technical support.

Fault Code	Fault type	Cause	Troubleshooting
<i>E 16</i>	Communication Fault	<ol style="list-style-type: none"> 1. the communication timeout is enabled for discontinuous communication system 2. SCI communication failure 	<ol style="list-style-type: none"> 1. Set F10.03 to 0.0 for discontinuous communication system 2. Check whether the communication cable is disconnected. 3. Adjust the communication overtime (F10.03).
<i>E 17</i>	Inverter Temperature Sensor Failure	<ol style="list-style-type: none"> 1. Inverter temperature sensor is off or short-circuited. 	<ol style="list-style-type: none"> 1. Check whether temperature sensor of inverter is properly wired. 2. Seek for technical support.
<i>E 18</i>	Soft Start Relay Unclosed	<ol style="list-style-type: none"> 1. The grid is interrupted. 2. Input voltage phase loss. 3. Wiring terminals of input voltage are loosened. 4. Input voltage drops too much. 5. Aging of switch contact on input power supply. 	<ol style="list-style-type: none"> 1. interruption of power supply should be done after the inverter stopped or reset the fault. 2. Check the input voltage and its wiring. 3. Tighten screws of input wiring terminal. 4. Check air switch and contactor.
<i>E 19</i>	Current Detection Circuit Fault	<ol style="list-style-type: none"> 1. Detection circuit of drive board or control board is damaged. 	<ol style="list-style-type: none"> 1. Seek for technical support.
<i>E20</i>	Stall Fault	<ol style="list-style-type: none"> 1. The set deceleration time is excessively short. 2. Energy consumption brake fault at coast-to-stop. 	<ol style="list-style-type: none"> 1. Increase set deceleration time. 2. Check energy consumption brake status.
<i>E21</i>	PID Feedback Disconnection	<ol style="list-style-type: none"> 1. PID feedback is higher than upper limit (F09.24) or lower than lower limit (F09.25), depending upon types of sensors. 	<ol style="list-style-type: none"> 1. Check whether the feedback line falls off. 2. Check whether the sensor works abnormally. 3. Adjust the feedback disconnection detection value to a reasonable level.
<i>E22</i>	Encoder Fault	<ol style="list-style-type: none"> 1. Encoder and PG card are not properly connected. 2. PG card is not installed properly. 3. PG card type is wrong or F01.24 (Encoder Type) is wrong. 4. Encoder is damaged. 5. Interference on site. 	<ol style="list-style-type: none"> 1. Check whether PG card and encoder are wired correctly. 2. Check whether PG card is properly inserted. 3. Please check PG card type or F01.24 (Encoder Type). 4. Replace encoder. 5. Adding ferrite cores to inverter output power cables

Fault Code	Fault type	Cause	Troubleshooting
<i>E23</i>	Keypad EEPROM Fault	<ol style="list-style-type: none"> Interference results in reading and writing errors of EEPROM. EEPROM damaged. 	<ol style="list-style-type: none"> Press STOP/RESET to reset and then try it again. Seek for technical support.
<i>E24</i>	Autotuning Fault	<ol style="list-style-type: none"> Press STOP/RESET in parameter autotuning. In autotuning, the external coast-to-stop terminal FRS=ON. Motor is not connected. Motor is not disconnected from load on rotational autotuning. Motor fault. 	<ol style="list-style-type: none"> Press STOP/RESET to reset. Check the connection between inverter and motor. Motor is disconnected from load on rotational autotuning. Check motor.
<i>E25</i>	Motor Overspeed Protection	<ol style="list-style-type: none"> No PG card is connected. Encoder Line Number (F01.25) is not set correctly. AB Phase Sequence (F01.27) is incorrect. Actual motor speed is larger than set speed of inverter or load pulls motor in an opposite way due to excessive load. 	<ol style="list-style-type: none"> Connect to PG card or replace control mode with V/F control mode. Set encoder line number as per the user manual of the encoder. exchange encoder AB wiring sequence. Reduce load or select another inverter and motor that are one speed level higher.
<i>E26</i>	Offload Protection	<ol style="list-style-type: none"> Enabled when motor current is lower than offload detection level F07.25 and this status is maintained for the time set through F07.26. Current detection module is damaged. 	<ol style="list-style-type: none"> Load is excessively light or offload level is not reasonable. Offload. Seek for technical support.
<i>E27</i>	Accumulated Power-On Time Reach	<ol style="list-style-type: none"> Set power-on time reach. 	<ol style="list-style-type: none"> Contact dealer.
<i>E28</i>	Accumulated Run Time Reach	<ol style="list-style-type: none"> Set run time reach. 	<ol style="list-style-type: none"> Contact dealer.
<i>E29</i>	Internal Communication Fault	<ol style="list-style-type: none"> Internal SPI communication fault. 	<ol style="list-style-type: none"> Power-on after power cut. Seek for technical support.
<i>E33</i>	CANopen Communication Overtime	<ol style="list-style-type: none"> Data Communication Overtime. 	<ol style="list-style-type: none"> Ensure that inverter is powered on again after the line is smooth.
<i>E34</i>	DeviceNET without Network Power Supply	<ol style="list-style-type: none"> No DC24V Power Supply is detected for DeviceNET bus. 	<ol style="list-style-type: none"> Power supply backs to normal.

Fault Code	Fault type	Cause	Troubleshooting
<i>E35</i>	DeviceNET BUS-OFF	1. Short circuit between CAN_H and CAN_L of DeviceNET bus.	1. Ensure that wiring is normally.
<i>E36</i>	DeviceNET MACID Detection Error	1. There is already a same station on the bus.	1. Power on inverter after address modification.
<i>E37</i>	DeviceNET IO Communication Overtime	1. NO IO message received within specified time during online status.	1. Ensure that inverter is powered on again after line is smooth.
<i>E38</i>	DeviceNET IO Mapping Error	1. IO Polling Data Address.	1. Make sure to input correct parameter address.
<i>E39</i>	Profibus-DP Parameterization Data Error	1. Incompliance of parameterization data sent by master with specification.	1. Make sure to receive correct parameterization data.
<i>E40</i>	Profibus-DP Configuration Data Error	1. Configuration data sent by master is not supported by slave card.	1. Make sure to receive correct configuration data.
<i>E41</i>	Profibus-DP IO Disconnection	1. At normal data exchange status, DP card has not received any data for a long time (disconnection between DP card and master), so it exists from data exchange status.	1. Enter data exchange status restoration fault.

When inverter has a fault above, press  to reset or use fault reset terminal to exit fault status; after the fault is cleared, inverter returns to function setting status; if the fault fails to be cleared, LED will continue to display present fault data.

Corresponding number is shown as below on reading fault by communication.

<i>0</i>	<i>5C</i>	<i>H0C</i>	<i>H0U</i>	<i>S0C</i>	<i>S0U</i>	<i>S5U</i>	<i>I L P</i>	<i>0 L P</i>	<i>0 L</i>	<i>0 H</i>
0	1	2	3	4	5	6	7	8	9	10

‘E’ of E11 and its subsequent failure is omitted. For example, corresponding number of ‘E11’ is ‘11’.



Check List of Capitalized English Letters Displayed:

<i>A</i>	<i>B</i>	<i>C</i>	<i>D</i>	<i>E</i>	<i>F</i>	<i>G</i>	<i>H</i>	<i>I</i>	<i>L</i>
A	B	C	D	E	F	G	H	I	L

<i>N</i>	<i>O</i>	<i>P</i>	<i>Q</i>	<i>R</i>	<i>S</i>	<i>T</i>	<i>U</i>	<i>X</i>	<i>Y</i>
N	O	P	Q	R	S	T	U	X	Y

After power is on, due to improper function setting and incorrect wiring between inverter and external control terminals, motor can not meet expected working requirements. Fault analysis as described in this chapter can be taken as the reference to take corrective actions. If trip codes appear, see 9.1 for corrective actions to clear the trips.

9.1.1 Parameters Unavailable for Setting

- When pressing  and , parameter display remains unchanged.

Some parameters can only be edited when inverter stops.

F12.02 is set by 1 or 2, parameter locking will happen, please set F12.02 as 0. Or setting the user password will appear the same situation.

9.1.2 Abnormal Motor Operation

- After pressing , motor does not run.
 - Start/Stop is in terminal control mode: Check F00.02 setting.
 - Coast-to-stop terminals FRS is connected to COM: Disconnect FRS from COM.
 - When terminal (Run Command Switched to Terminal) is on and run command is only in terminal control mode: Switch terminal off.
 - Status combination of run command input is in terminal control mode: Change it to keypad control mode.
 - Setting reference input frequency= 0: Increase reference input frequency.
 - Power supply is abnormal or control circuit fails.
- When control terminals RUN and F/R are ON, motor does not run.
 - External terminal start/stop setting is disabled: Check setting of F00.02.
 - Coast-to-stop terminal FRS=ON: Switch FRS=OFF.
 - Control switch is disabled: Check control switch.
 - Setting reference input frequency= 0: Increase reference input frequency.
- Motor can only run in one direction.
Reverse prohibited: When F0-24=1, inverter reverse is prohibited.
- Motor reverses

Output phase sequence of inverter is not identical to that of motor input: When power is off, running direction of motor can be changed by switching any of the two connection wires on the output side of inverter.

9.1.3 Excessively Long Acceleration Time

- Excessively low setting of current limit

When current limit is enabled, if inverter output current reaches its set current limit, then output frequency will remain unchanged in acceleration, and it will rise continuously only until output current is lower than set current limit. In this case, motor acceleration time is longer than set time. Check if set current limit of inverter is excessively low.

- If set acceleration time is too long, confirm its parameters.

9.1.4 Excessively Long Deceleration Time

- When energy consumption brake is enabled,
 - Brake resistance value is too big and energy consumption brake power is too small, so deceleration time is prolonged.
 - Set value of brake duty ratio (F15.32) is too small, and deceleration time is prolonged. Please increase set value of brake duty ratio.
 - If set acceleration time is too long, confirm its parameters.
- When overvoltage stall protection is enabled,
 - Overvoltage stall protection is enabled, when DC bus voltage exceeds overvoltage stall voltage (F07.07), output frequency remains unchanged. When DC bus voltage is lower than F07.07, output frequency drops continuously and therefore deceleration time is prolonged.
 - If set acceleration time is too long, confirm its parameters.

9.1.5 Electromagnetic Interference (EMI) and Radio Frequency Interference (RFI)

- When inverter runs in high frequency switch status, it will generate EMI and RFI on the control devices. Take following countermeasures:
 - Lower carrier frequency of inverter (F00.23).
 - Install noise filter on the input side of inverter.
 - Install noise filter on the output side of inverter.
 - Shield cable with metal tube, and place inverter in a metal case.
 - Inverter and motor must be grounded reliably.
 - Main circuit and control circuit shall be wired separately. Control circuit shall adopt shielded wire, and see Chapter 3 for wiring.

9.1.6 Leakage Current Circuit Breaker for Leakage Protection

- When inverter runs, leakage current circuit breaker is triggered for leakage protection. Inverter outputs high-frequency PWM signal, which generates high-frequency leakage current. Please select leakage circuit breaker with trigger current $\geq 30\text{mA}$. For regular circuit breaker, then trigger current $\geq 200\text{mA}$ and active time at 0.1S or above.

9.1.7 Mechanical Vibration

- Inherent frequency of mechanical system resonates with carrier frequency of inverter. Motor has no problem, but sharp noises generated by the mechanical system resonate between inherent frequency of mechanical system and carrier frequency of inverter. Please adjust carrier frequency F0-14 to avoid resonant frequency.
- Inherent frequency of mechanical system resonates with output frequency of inverter. Inherent frequency of mechanical system resonates with output frequency of inverter. Please use oscillation suppression function (F05.13) or install vibration-proof rubber at motor bottom plate and take any other vibration-proof measures.
- PID Control Oscillation
P, Ti and Td of PID controller do not match in setting properly. Reset PID parameters.

9.1.8 Inverter Stops Output While Motor Still Rotates

- Insufficient DC Brake at Stop
 - DC brake torque at stop is too small. Please increase set value of DC brake current at stop (F04.21).
 - DC brake time at stop is too short. Please increase DC brake time at stop (F04.22). Generally speaking, increase DC brake current at stop first.

9.1.9 Output Frequency Not As Per the Set Frequency

- Set frequency exceeds upper limit frequency.
If set frequency exceeds set value of upper limit frequency, then output frequency shall be upper limit frequency. Reset set frequency within upper limit frequency; or check whether F00.16, F00.17 and F00.18 are appropriate.

10 Maintenance and Inspection

10.1 Routine Maintenance and Inspection of Inverter

Changes of working environment of inverter, such as temperature, humidity, smog and dust, as well as aging of inner parts, can cause various inverter faults. Therefore, routine inspection and regular maintenance shall be performed during storage and use.

- Before using inverter, user shall check if components are broken or screws are loose during transport.
- While using inverter, user shall regularly clean dust and check whether screws are loosened.
- If inverter is left unused for a long term, user is recommended to power on inverter every half year during storage. Every time, inverter shall be powered on for half an hour. This will prevent electronic device from invalidation.
- Keep inverter away from heavy humidity and metal particles. If necessary, put it in an electric cabinet or a small room with protective measures.
- When inverter is in normal running, please check items below:
- Whether motor sounds abnormally or vibrates.
- Whether inverter and motor are overheated abnormally.
- Whether ambient temperature is too high.
- Whether output current value is normal.
- Whether cooling fan of inverter runs normally.

According to service applications, clients shall regularly inspect inverter for clearing faults and potential safety hazards. Cut off power supply before checking, and start checking after keypad LED goes out. Items to be checked are shown in Table 10-1.

Table 10-1 Items for Routine Check

Items	Inspection content	Countermeasures
Screws of main circuit terminal and control circuit terminal	Whether screws are loosened.	Tighten screws with a screwdriver.
Cooling fin	Whether there is dust or foreign object.	Clean up dust and foreign objects with dry-compressed air of 4-6 kg/cm ² pressure.
PCB		
Cooling fan	Whether there is abnormal sound or vibration. Whether accumulated run time has reached to 20,000 hours.	Replace cooling fan.
Power module	Whether there is dust.	Clean up dust and foreign objects with dry-compressed air of 4-6 kg/cm ² pressure.
Electrolytic Capacitor	If there is color change, foreign odor or blister.	Replace electrolytic capacitor.

In order to make inverter operate normally, regular maintenance and change must be performed for the purpose of service life of inner components of inverter. Service lives of inverter components vary with service environment and applications. In Table 10-2, replacement terms of interver components are just for user reference.

Table 10-2 Replacement Terms of Inverter Components

Component	Standard replacement years
Cooling fan	2 – 3 years
Electrolytic capacitor	4 – 5 years
PCB (Printed circuit board)	5 – 8 years

In the table above, replacement terms are based upon service applications for components of inverter below:

Ambient temperature: annual average 30 °C.

Load factor: below 80%.

Running time: below 12 hours per day.

10.2 Warranty Instruction for Inverter

SINEE will offer warranty service if inverter has the following applications:

Warranty is only for inverter; warranty service will be provided to inverter that has a fault or is damaged within 12 months during normal use; if inverter has a fault or is damaged outside the 12-month period during normal use, reasonable maintenance charge is required.

There is maintenance charge for any following damage occurred in 12 months:

- Due to improper operation.
- Due to flood, fire, or abnormal voltage fluctuation.
- Due to incorrect wiring.
- Due to unauthorized change or modification.
- Service fees are subject to actual fees.
- If there is another agreement, the agreement shall apply.
- Associated service charges are based on the actual costs.
- Alternative agreement is higher priority.

11 Options

11.1 Braking Resistor

If motor speed falls too fast or motor load shakes too frequently during inverter running, its electric potential energy will charge inner capacitor through inverter in a reverse way, leading to voltage pump up at both ends of power module, which easily damages inverter. Internal control of inverter can suppress this situation based on load condition and when braking feature can not meet user demands, external braking resistor is required to release energy timely. External braking resistor functions for energy consumption brake, which will dissipate all energy to power braking resistor. So, select reasonable and effective power and resistance for braking resistor.

The power of braking resistor is according to the following formula.

P_b (The power of braking resistor) = P (the power of inverter) * D (braking frequency)

D - Braking frequency (estimated value)

Normally braking $D = 10\%$

Occasionally braking $D = 5\%$

Elevator braking $D = 10\% \sim 15\%$

Lifting braking for height more than 100m $D = 50\% \sim 60\%$

The table below for the EM500 series inverter is recommended rated power of braking resistor which is for reference only ($D = 10\% \sim 20\%$). If braking frequency is larger the power of braking resistance should be larger.

Inverter model	Motor (kW)	Resistance (Ω)	Resistor power (W)	Cable connected to the resistor (mm ²)
EM500-0R7G/1R5P-1B/2B/3B	0.75	≥ 360	≥ 200	1
EM500-1R5G/2R2P-1B/2B/3B	1.5	≥ 180	≥ 400	1.5
EM500-2R2G/3R0P-1B/2B/3B	2.2	≥ 180	≥ 400	1.5
EM500-4R0G/5R5P-3B	4	≥ 90	≥ 800	2.5
EM500-5R5G/7R5P-3B	5.5	≥ 60	≥ 1000	4
EM500-7R5G/9R0P-3B	7.5	≥ 60	≥ 1000	4
EM500-011G/015P-3B	11	≥ 30	≥ 2000	6
EM500-015G/018P-3B	15	≥ 30	≥ 2000	6
EM500-018G/022P-3B	18.5	≥ 30	≥ 2000	6
EM500-022G/030P-3/3B	22	≥ 15	≥ 4000	6
EM500-030G/037P-3/3B	30	≥ 15	≥ 4000	6
EM500-037G/045P-3/3B	37	≥ 10	≥ 6000	6
EM500-045G/055P-3/3B	45	≥ 10	≥ 6000	6
EM500-055G/075P-3/3B	55	≥ 7.5	≥ 8000	6
EM500-075G/090P-3/3B	75	≥ 6	≥ 8000	6

★ The cable listed above refers to outgoing line of individual resistor. When resistor is

connected in parallel, the bus in connection should be amplified accordingly. Single-phase inverter selects voltage withstanding type cable of AC300 V, 3-phase inverter uses cable of over AC450V and temperature resistance 105 °C.

11.2 Braking Unit

If EM600 inverter (over 18.5 kW) has no built-in braking unit (22 – 75 kW optional internal braking unit), then user shall select our BR100 braking units (power range: 18.5 – 315 kW). Models of braking units are listed below:

Model No.	Application	Minimum resistance (Ω)	Average braking current I_{av} (A)	Peak current I_{max} (A)	Inverter power (kW)
BR100-045	Energy consumption brake	10	45	75	18.5 - 45
BR100-160	Energy consumption brake	6	75	150	55 - 160
BR100-315	Energy consumption brake	3	120	300	185 - 315

★ When BR100-106 adopts minimum resistance, it can continue to work if braking frequency of braking unit $D=33\%$. If $D>33\%$, it needs to work intermittently, otherwise an overheat protection fault will occur.

11.3 Options of Cable

Because all braking units and braking resistors work at high voltage (>400VDC) discontinuously, please select appropriate cable. See Table 11-1 for specification of cable of main circuit. During wiring, only cable with insulation grade and section meeting standards shall be used.

Table 11-1 Cable for Braking Unit and Braking Resistor

Model No.	Average braking current I_{av} (A)	Peak current I_{max} (A)	Section of copper core cable (mm^2)
BR100-045	45	75	10
BR100-160	75	150	16
BR100-315	120	300	25

Flexible cable has better flexibility. Since cable may contact high-temperature device during use, it's better to use copper core or heat-proof flexible cable or fire-retardant cable. Braking unit and inverter shall be as close as possible to each other, and it's better to keep

their distance no more than 2 m, otherwise DC side cable shall be twisted and sheathed with magnetic ring to reduce radiation and inductance.
 Lengths of cable among braking unit, braking resistor and inverter are illustrated in Figure 11-1:

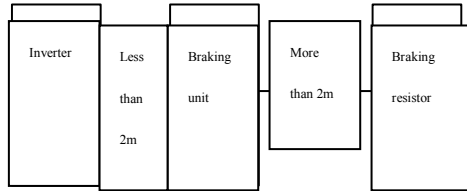

Figure 11-1 Cable Length

11.4 Option Card

11.4.1 I/O Expansion Card Configuration

I/O expansion card is used for expanding inverter control terminal. Specific model of I/O card is listed in Table 11-2.

Table 11-2 Model of I/O Card

Model No.	Description	Terminal Function
EC-IO-A1	Expansion Card	4 numeric multi-function signal inputs: X8 - X11 1 numeric signal output: Y3 1 analog signal input: AI4

11.4.2 PG Card Configuration

EM600 inverter is equipped with multiple general PG cards. User shall select PG card based on encoder output form. Models of PG cards are listed in Table 11-3.

Table 11-3 Model List of PG Card

Model No.	Description	Encoder interface
EC-PG-O1	open collector output encoder complementary push-pull output encoders encoder with voltage output	6PIN connection terminal
EC-PG-O2	open collector output encoder complementary push-pull output encoders encoder with voltage output With frequency dividing output and PG output is open collector.	Input: 6PIN connection terminal Output: 4PIN connection terminal
EC-PG-D1	Differential output encoder (long line drive encoder) Wire-saved UVW differential output encoder	9PIN connection terminal
EC-PG-D3	Differential output encoder (long line drive encoder) Wire-saved UVW differential output encoder With frequency dividing output and PG output is open collector.	Input: 9PIN connection terminal Output: 4PIN connection terminal
EC-PG-U1	UVW differential output encoder	DB15 female connector
EC-PG-R1	Rotary transformer output encoder	DB9 female connector

11.4.3 Communication Card Configuration

EM600 inverter is equipped with multiple communication expansion cards. Models of expansion cards are listed in Table 11-4.

Table 11-4 Models of Communication Expansion Cards

Model No.	Description	Communication Rate
EC-CM-C1	CANopen Communication Card	125 kbps, 250 kbps, 500 kbps and 1 Mbps
EC-CM-D1	DeviceNet Communication Card	125 kbps, 250 kbps and 500 kbps
EC-CM-P1	Profibus-DP Communication Card	Bit rate self-adaptation

11.5 Base

Five specifications of EM600 inverters can have an installation base that has the same width as that of corresponding inverter, as shown in Figure 11-2. Installation method for EM600 is changed to cabinet mounting. If required, please indicate it while ordering and install it by yourself. Refer to Figure 11-3 for details. Installation dimensions for anchor bolt of the base are shown in Figure 11-4 and Table 11-5.

Table 11-5 Base Installation Dimensions

Model No.	Base Height(mm)	W(mm)	H(mm)	d(mm)
EM600-055 - 075	165	300	243	13
EM600-090 - 132	253	300	243	13
EM600-160 - 200	253	300	258	13
EM600-220 - 280	308	416	293	13
EM600-315 - 400	300	500	340	13

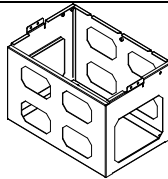

Figure 11-2 Base

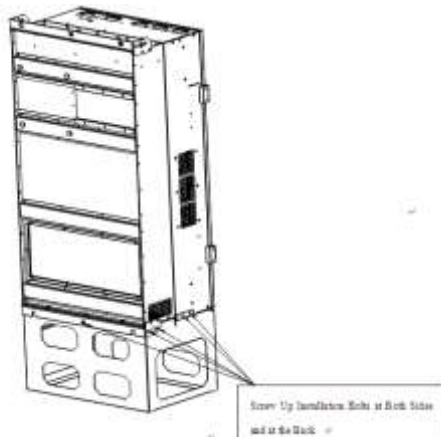

Figure 11-3 Base Installation

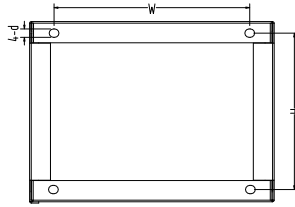

Figure 11-4 Installation Dimensions of Anchor Bolt of Base

EM600 large-power inverter (450 - 560kW) can be accompanied with an installation base and top cover with the same width as inverter (refer to Figure 11-6). The overall inverter height can be changed to 2000mm, if base or top cover will be replaced; the overall inverter can be changed to 2200mm, if both base and top cover will be replaced. If required, please inform while ordering and complete installation by yourself. See Figure 11-6 for details.

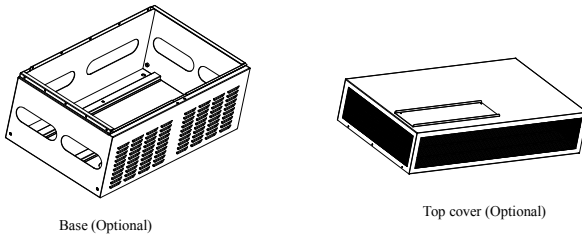

Figure 11-5 Base and Top Cover of Inverter (450 - 560kW)

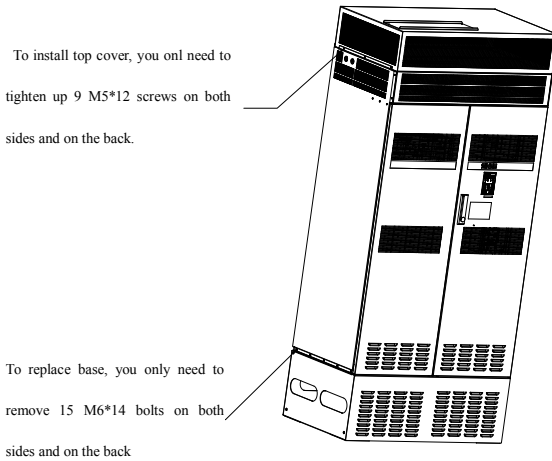

Figure 11-6 Installation of Base and Top Cover of Inverter (450 - 560kW)

11.6 11.6 Upper Mounting Hole

EM500 large-power inverter (450 - 560kW) can be accompanied with upper mounting hole to make the machine stand against wall with machine back. If required, please inform while ordering and complete installation by yourself. See Figure 11-7 for details.

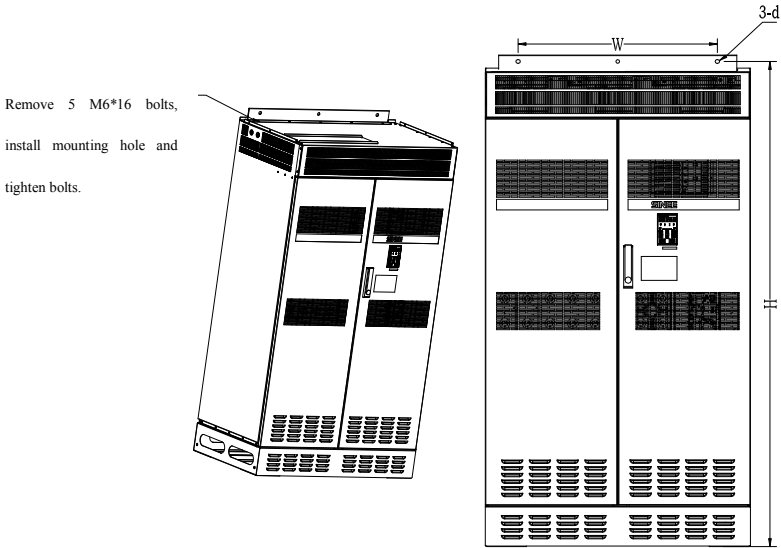

Figure 11-7 Installation of Upper Mounting Hole

Table 11-6 Installation Dimension of Upper Mounting Hole

Model No.	W(mm)	H(mm)	d(mm)
EM500-450G/500P-3	753	1825	14
EM500-500G/560P-3			
EM500-560G/630P-3			

11.7 Copper Row for Incoming and Outgoing Cable Switchover

Two specifications of EM600 can have a copper row for incoming and outgoing cable switchover, which can be wired outside the case (see Figure 11-8). If required, please indicate it while ordering and install it by yourself.

Model No.	List of options
EM600-220 - 280	Copper row for incoming and outgoing cable switchover, installation bolt and insulator
EM600-315 - 400	Copper row for incoming and outgoing cable switchover, installation bolt and insulator

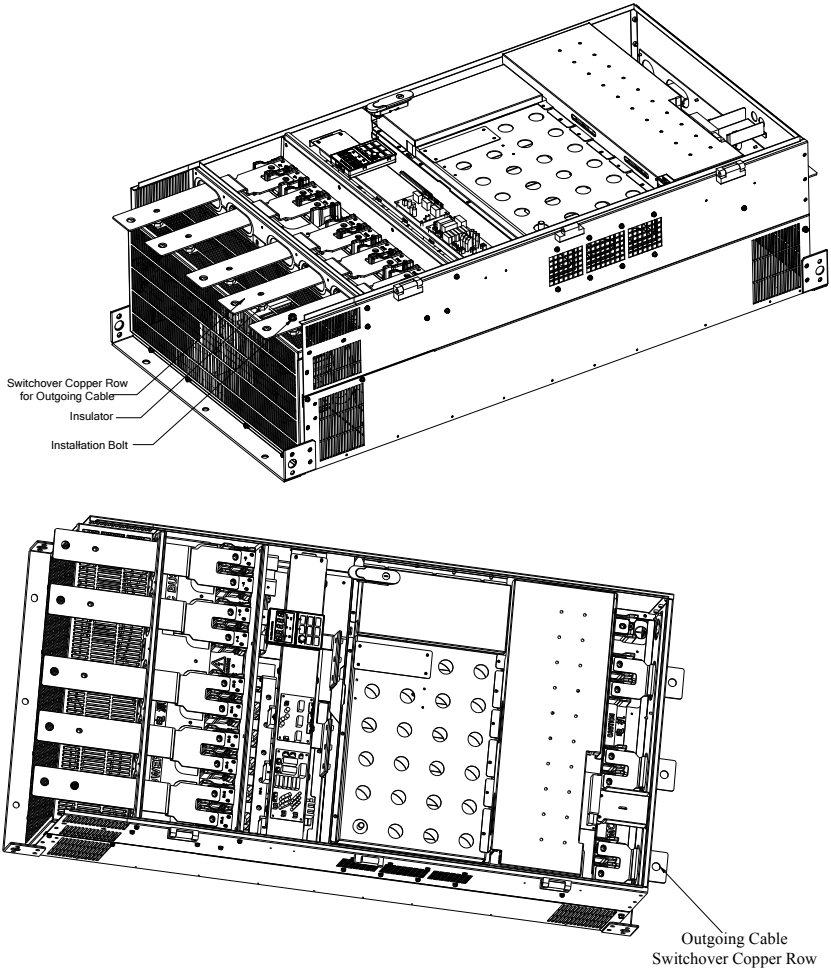

Figure 11-8 Installation of Copper Row for Incoming and Outgoing Cable Switchover

11.8 LCD keypad

Details please refer to the LCD keyboard user manual.

12 MODBUS Communication Protocol

12.1 Application Scope

1. Applicable series: EM600
2. Applicable network: Support MODBUS-RTU protocol, with single-master/multi-slave communication network of RS-485 bus.

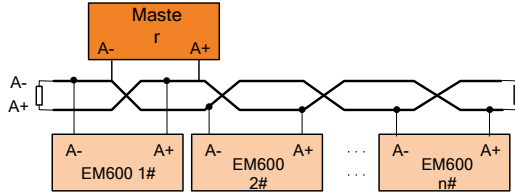

12.2 Physical Interface

RS-485 asynchronous half-duplex communication mode is with least significant bit given the priority for transmittance.

RS-485 network address: 1 – 247 available for setting, 0 is broadcast address.

RS-485 terminal default data format: 1-8-N-1^[2] (1-8-E-1, 1-8-O-1, 1-8-N-2, 1-8-E-2 and 1-8-O-2, optional).

Default bit rate of RS-485 terminal: 9600 bps (4800 bps, 19200 bps, 38400 bps, 57600 bps and 115200 bps, optional);

It's recommended to use shielded twisted cable as communication cable so as to reduce impacts of external disturbance upon communication.

[2] 1-8-N-1, 1 start bit – 8 characters per byte data – nonparity – 1 stop bit. E, even parity; o, odd parity.

12.3 Protocol Format

12.3.1 Message Format

As shown in Figure 12-1, a standard MODBUS message includes start mark, RTU message (Remote Terminal Unit) and end mark.

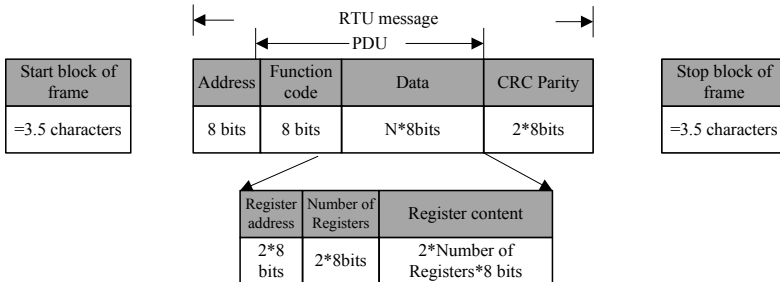

Figure 12-1 RTU Message Frame

RTU message includes address code, PDU (Protocol DataUnit) and CRC^[3] Parity. PDU comprises function code and data (mainly including register address, register number and register content; all function codes have different definitions, see function code 12.3.3).
 [3]: CRC parity, with low byte in the front and high byte in the back.

12.3.2 Address Code

Address Scope	Purpose
1 - 247	Slave
0	Broadcast

12.3.3 Function Code

MODBUS function code classification is shown in Figure 12-2.

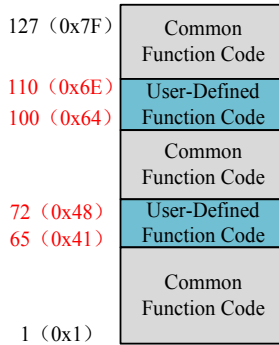

Figure 12-2 MODBUS Function Code Classification

As shown in Table 12-1, EM600 inverters mainly involve common function codes, for example 0x03 read multiple registers or status words, 0x06 write single register or command, 0x10 write multiple registers or commands, and 0x08 diagnosis function code. Besides, to perform some special functions, for example write register RAM and not to save in EEPROM, user shall define 0x41 as write single register or command (no to save) and 0x42 as write multiple registers or commands in user-defined function code area (no to save).

After receiving abnormal valid data from device, relevant abnormal information (see 12.3.7 Abnormal Information Response) will be returned. For distinguishing it from normal communication data, abnormal function codes are defined. Similar to normal request function code, abnormal function code = request function code + 0x80.

Table 12-1 EM600 Defined Function Code

Function Code	Abnormal Function Code	Function
03	83	Read multiple registers or status bytes.
41	C1	Write single register or command (not to save)
42	C2	Write multiple registers or commands (not to save)
08	88	Diagnosis function code
06	86	Write single register or command
10	90	Write multiple registers or commands

In the following sections, PDUs different depending upon functions shall be explained in detail.

12.3.3.1 Function Code 0x03 Read Multiple Registers or Status Bytes

In remote device, inverter uses this function code to read content of continuous blocks of holding register. Request PDU indicates start register address and number of registers.

Divide register data of response message into two bytes for each register. For each register, the first byte includes high bit, the second byte includes low bit.

- Request PDU

Function Code	1 byte	0x03
Initial Address	2 bytes	0x0000 - 0xFFFF
Number of Registers	2 bytes	1 - 16

- Response PDU

Function Code	1 byte	0x03
Number of Bytes	1 byte	2×N*
Register Value	N*×2 bytes	

N*=Number of Registers

- Incorrect PDU

Error Code	1 byte	0x83
Exception Code	1 byte	01, 02, 03 or 04

The following is an example of requesting to read registers F19.00 - F19.05 (relevant information about last fault):

Request		Response			
Field Name	(0x)	Field Name (normal)	(0x)	Field Name (abnormal)	(0x)
Function Code	03	Function Code	03	Function	83
Initial Address Hi	13	Number of Bytes	0C	Exception Code	03 (Example, the same below)
Initial Address Lo	00	(F19.00)Register Value Hi (F19.00)	00		
Number of Registers Hi	00	Register Value Lo (F19.00)	11		
Number of Registers Lo	06	Register Value Hi (F19.01)	00		
		Register Value Lo (F19.01)	00		
		Register Value Hi (F19.02)	00		
		Register Value Lo (F19.02)	00		
		Register Value Hi (F19.03)	01		
		Register Value Lo (F19.03)	2C		
		Register Value Hi (F19.04)	00		
		Register Value Lo	00		

	(F19.04)		
	Register Value Hi (F19.05)	00	
	Register Value Lo (F19.05)	00	

Telling from returned data, inverter has suffered 17 (0011H): abnormal failure of temperature sensor. At the time, there are output frequency 0.00 Hz, output current 0.00 A, bus voltage 300 V (012CH), acceleration/deceleration status (standby) and working hours 0 hour.

★ Present function code 0x03 of MODBUS protocol supports “cross-group read of multiple function codes”; but user is not recommended to do cross-group read, so that user’s application does not need to upgrade after we upgrade our products.

12.3.3.2 Function Code 0x41 Write Single Register or Command (Not to Save)

This function code can be used to write single non-holding register in a remote device. Request PDU describes address of written register.

Normal response is a response to request and returned after writing register.

● Request PDU

Function Code	1 byte	0x41
Register Address	2 bytes	0x0000 - 0xFFFF
Register Value	2 bytes	0x0000 - 0xFFFF

● Response PDU

Function Code	1 byte	0x41
Register Address	2 bytes	0x0000 - 0xFFFF
Register Value	2 bytes	0x0000 - 0xFFFF

● Incorrect PDU

Error Code	1 byte	0xC1
Exception Code	1 byte	See Table 12-4

The following is an example of a request for changing main frequency source A (7001H) to “-50.00%”.

Request		Response			
Field Name	(0x)	Field Name (normal)	(0x)	Field Name (abnormal)	(0x)
Function	41	Function	41	Function	C1
Register Address Hi	70	Register Address Hi	70	Exception Code	03
Register Address Lo	01	Register Address Lo	01		
Register Value Hi	EC	Register Value Hi	EC		
Register Value Lo	78	Register Value Lo	78		

★ This function code can not be used to change parameters of “○” property (unavailable to be modified during inverter running), i.e., user can only operate parameters of “●” property (available to be modified during inverter running). If user tries to modify “○” property, error code 1 will be returned.

12.3.3.3 Function Code 0x42 Write Multiple Registers or Commands (Not to Save)

This function code is used to write continuous non-holding register blocks (1 to 16 registers) in a remote device.

Value requested for writing is described in request data field. Each register divides data into two bytes.

Normal response shall return function, initial address and number of registers written.

- Request PDU

Function Code	1 byte	0x42
Initial Address	2 bytes	0x0000 - 0xFFFF
Number of Registers	1 byte	1 - 16
Number of Bytes	1 byte	2×N*
Register Value	N*×2 bytes	

N*=Number of Registers

- Response PDU

Function Code	1 byte	0x42
Initial Address	1 byte	0x0000 - 0xFFFF
Number of Registers	1 byte	1 - 16

- Incorrect PDU

Error Code	1 byte	0xC2
Exception Code	1 byte	See Table 12-4

The following is an example of a request for setting acceleration time 1 (F00.14) as 5.00 and deceleration time 1 (F00.15) as 6.00:

Request		Response			
Field Name	(0x)	Field Name (normal)	(0x)	Field Name (abnormal)	(0x)
Function	42	Function	42	Function	C2
Initial Address Hi	00	Initial Address Hi	00	Exception Code	03
Initial Address Lo	0E	Initial Address Lo	0E		
Number of Registers Hi	00	Number of Registers Hi	00		
Number of Registers Lo	02	Number of Registers Lo	02		
Number of Bytes	04				
Register Value Hi (F00.14)	01				
Register Value Lo (F00.14)	F4				
Register Value Hi (F00.15)	02				
Register Value Lo (F00.15)	58				

★ This function code can not be used to change parameters of “○” property (unavailable to be modified during inverter running), i.e., user can only operate parameters of “●” property (available to be modified during inverter running). If user tries to modify “○” property, error code 1 will be returned.

12.3.3.4 Diagnosis Function Code 0x08

Function code 08 of Modbus offers a series of tests for checking the communication system between client end (master) and server (slave) or checking various internal error status in the server.

This function uses 2-byte sub-function code field in inquiry to define the executed test type. In normal response, the server will copy function code and sub-function code. Some deagnostic functions can cause remote device to return corresponding data through normal response data field.

Generally, sending diagnosis function command to a remote device will not affect user program in the remote device. Diagnosis function can not have access to user logic, for example discrete magnitude and register. Some functions can be used to reset error counter in recent device.

Diagnosis function of our products is mainly line diagnosis (0000) and used for testing normal communication of master and slaves. Normal response to inquiry data request shall return the same data and copy function code and the sub-function code.

- Request PDU

Function Code	1 byte	0x08
Sub-Function Code	2 bytes	0x0000 - 0xFFFF
Data	2 bytes	0x0000 - 0xFFFF

- Response PDU

Function Code	1 byte	0x08
Sub-Function Code	2 bytes	0x0000 - 0xFFFF
Data	2 bytes	0x0000 - 0xFFFF

- Incorrect PDU

Error Code	1 byte	0x88
Exception Code	1 byte	See Table 12-4

- Sub-Function Code

Sub-Function Code	Indication	Data Field (Request)	Data Field (Response)
0000	Return Inquiry Data	Any	Copy request data
...			

0000: Return data transmitted in request data field in response. All messages shall be the same like request messages.

The following is an example of requesting remote device to return inquiry data. It uses sub-function code 0000. Using 2-byte data field (0xA537) to return data.

Request		Response			
Field Name	(0x)	Field Name (normal)	(0x)	Field Name (abnormal)	(0x)
Function	08	Function	08	Function	88
Sub-Function Code Hi	00	Sub-Function Code Hi	00	Exception Code	03
Sub-Function Code Lo	00	Sub-Function Code Lo	00		
Data Hi	A5	Data Hi	A5		
Data Lo	37	Data Lo	37		

12.3.3.5 Function Code 0x06 Write Single Register or Command

This function code is used to write single holding register in remote device.

Request PDU describes address of written register.

Normal response is a response to request and returned after writing register.

- Request PDU

Function Code	1 byte	0x06
Register Address	2 bytes	0x0000 - 0xFFFF
Register Value Hi	2 bytes	0x0000 - 0xFFFF

- Response PDU

Function Code	1 byte	0x06
Register Address	2 bytes	0x0000 - 0xFFFF
Register Value Hi	2 bytes	0x0000 - 0xFFFF

- Incorrect PDU

Error Code	1 byte	0x86
Exception Code	1 byte	See Table 12-4

The following is an example of requesting to change motor 1 drive control mode (F00.01) to 2: FVC:

Request		Response			
Field Name	(0x)	Field Name (normal)	(0x)	Field Name (abnormal)	(0x)
Function	06	Function	06	Function	86
Register Address Hi	00	Register Address Hi	00	Exception Code	03
Register Address Lo	01	Register Address Lo	01		
Register Value Hi	00	Register Value Hi	00		
Register Value Lo	02	Register Value Lo	02		

★ Frequently changed function codes of inverter can not complete this with 0x06 to avoid damaging inverter.

0x41 RAM & EEPROM, a user-defined function code, corresponds to standard common function code 0x06; the definition of this function code is the same as corresponding standard function code (in request, response and error PDU). The only difference is that when this function code is enabled, only corresponding value of RAM is modified, without being saved to EEPROM (holding register).

For those function codes that are often changed, like F00.07, it's recommended to use 0x41 (user can also operate 7001H directly by modifying main frequency source A, refer to 12.3.3.2 and 12.3.4 for details) to avoid damaging inverter. See the following description

for details.

Request		Response	
Field Name	(0x)	Field Name (normal)	(0x)
Function	41	Function	41
Register Address Hi	00	Register Address Hi	00
Register Address Lo	07	Register Address Lo	07
Register Value Hi	13	Register Value Hi	13
Register Value Lo	88	Register Value Lo	88

Data above means to change set frequency (F00.07) to 50.00Hz, which will take effect immediately, but will not be saved in EEPROM. After rewriting, inverter runs at 50.00 Hz, but runs at set frequency prior to change after inverter is powered on.

12.3.3.6 Function Code 0x10 Write Multiple Registers or Commands

This function code is used to write continuous register blocks (1 to 16 registers) in a remote device.

Value requested for writing is described in request data field. Each register divides data into two bytes.

Normal response is to return function code, initial address and number of registers written.

- Request PDU

Function Code	1 byte	0x10
Initial Address	2 bytes	0x0000 - 0xFFFF
Number of Registers	2 bytes	1 - 16
Number of Bytes	1 byte	2×N*
Register Value	N*×2 bytes	

N*=Number of Registers

- Response PDU

Function Code	1 byte	0x10
Initial Address	2 bytes	0x0000 - 0xFFFF
Number of Registers	2 bytes	1 - 16

- Incorrect PDU

Error Code	1 byte	0x90
Exception Code	1 byte	See Table 12-4

The following is an example of requesting to write 00 01 and 00 03 in the two registers starting from F03.00, i.e., setting functions of output terminals Y1 and Y2.

Request		Response			
Field Name	(0x)	Field Name (normal)	(0x)	Field Name (abnormal)	(0x)
Function	10	Function	10	Function	90
Initial Address Hi	03	Initial Address Hi	03	Exception Code	03
Initial Address Lo	00	Initial Address Lo	00		
Number of Registers Hi	00	Number of Registers Hi	00		
Number of Registers Lo	02	Number of Registers Lo	02		
Number of Bytes	04				
Register Value Hi (F03.00)	00				

Request		Response			
Field Name	(0x)	Field Name (normal)	(0x)	Field Name (abnormal)	(0x)
Register Value Lo (F03.00)	01				
Register Value Hi (F03.01)	00				
Register Value Lo (F03.01)	03				

★ Frequently changed function codes of inverter can not complete this with 0x10 to avoid damaging inverter. Refer to 12.3.3.5 for details.

12.3.4 Allocation of Register Address

Table 12-2 MODBUS Protocol Register Address Definitions

Address Space		Description	
Function Code 0000H - 6F63H		For function codes FXX.YY, their high addresses are in hexadecimal format of XX and their low addresses are in hexadecimal format of YY. For example F12.03, its address is 0C03H (12D=0CH, 03D=03H).	
Control Command (Write Only) 7000H - 71FFH	7000H Control Word	0000H	Disabled Command
		0001H	Forward Running
		0002H	Reverse Running
		0003H	Forward JOG
		0004H	Reverse JOG
		0005H	Ramp-To-Stop
		0006H	Rapid Stop
		0007H	Coast-to-Stop
		0008H	Fault Reset
		0009H	+/-Input Switch
	000BH	JOG Stop	
	Other - 00FFH		Not Used
	7001H	Main Channel Frequency A Communication Percentage Setting	-100.00% - 100.00% (100%=maximum frequency)
	7002H	Auxiliary Channel Frequency B Communication Percentage Setting	-100.00% - 100.00% (100%=maximum frequency)
	7003H	Torque Communication Setting	-200.00% - 200.00% (100%=Numeric Torque Setting Reference)
7004H	Process PID Communication Setting	-100.00% - 100.00%	
7005 H	Process PID Feedback Communication Setting	-100.00% - 100.00%	
7006H	VF separation mode voltage setting	0.00% - 100.00% (Numeric Setting Reference)	
7007H - 7009H	Not Used		

Address Space		Description		
	700AH	Upper Limit Frequency Communication Setting	0.00% - 200.00% (Numeric Setting Reference)	
	700BH	Upper Limit Frequency Setting of Torque Control	0.00% - 200.00% (Numeric Setting Reference)	
	700CH	Linear Speed Input of Inertia Compensation	0.00% - 100.00% (Numeric Setting Reference)	
	700DH - 700EH	Not Used		
	700 FH	Master-Slave Communication Setting	-100.00% - 100.00% (Maximum Reference Value)	
	7010H - 7013H	Not Used		
	7014H	External fault	External device (including option card) fault input	
	7015H	Communication Setting of Main Channel Frequency A	0.00Hz - maximum frequency	
	7016H	Communication Setting of Auxiliary Channel Frequency B	0.00Hz - maximum frequency	
	7017H	Communication Setting of Upper Limit Frequency	0.00Hz - maximum frequency	
	7018H	Communication Setting of Upper Limit Frequency at Torque Control	0.00Hz - maximum frequency	
	7019H	Communication Setting of Upper Limit Torque at Speed Control	0.0~250.0%	
7020H - 71FFH	Not Used			
Working Condition 7200H - 73FFH	7200H, status word 1	Bit7 - 0 Running Status	00H	Parameter Setting
			01H	Slave Running
			02H	JOG Running
			03H	Autotuning Status
			04H	Slave Stop
			05H	JOG Stop
			06H	Fault Status
			07H	Factory Inspection
	08H - 0FFH	Not Used		
	Bit15 - 8	00H	Inverter runs normally	

Address Space		Description							
		Fault Information		xxH	Fault status of inverter, “xx” is the fault code.				
	7201H Status word 2	Bit0 Set Direction		1	-: Valid Setting				
				0	+: Valid Setting				
		Bit1 Running Direction		1	Frequency Output, Reverse				
				0	Frequency Output, Forward				
		Bit 3 - 2 Control Mode		00	Speed Control Mode				
				01	Torque Control Mode				
				10	Servo Control Mode				
				11	Not Used				
		Bit4 Parameter Protection		1	Enabled				
				0	Disabled				
		Bit 6 - 5		Not Used					
		Bit 8 - 7 Set Mode		00	Keypad Control				
	01			Terminal Control					
	10			Communication Control					
	11			Not used					
	Bit9		Not Used						
	Bit15 - 10		Not Used						
	7202H Monitoring frequency +/- status word 1 (1: -; 0: +)	Bit0		Output Frequency					
		Bit1		Input Frequency					
Bit2		Synchronous frequency							
Bit3		PG Feedback Frequency							
Bit4		Estimated Feedback Frequency							
Bit5		Estimated Slip Frequency							
Bit6		Load Speed							
Bit 15 - 7		Not Used							
7203H	Output Frequency								
7204H	Output Voltage								
7205H	Output Power								
7206H	Running Speed								
7207H	Bus Voltage								
7208H	Output Torque								
7209H	Switch Quantity Input 1	15	14	13	12	11	10	9	8
		*	*	*	*	*	X11	X10	X9
		7	6	5	4	3	2	1	0
		X8	X7	X6	X5	X4	X3	X2	X1
720AH	Switch Quantity Input 2	15	14	13	12	11	10	9	8
		VX8	VX7	VX6	VX5	VX4	VX3	VX2	VX1
		7	6	5	4	3	2	1	0
		*	*	*	*	A14	A13	A12	A11
720BH	Switch Quantity	15	14	13	12	11	10	9	8
		*	*	*	*	*	*	*	*

Address Space		Description									
		Output 1	7	6	5	4	3	2	1	0	
			*	*	*	Y3	Y2	Y1	R2	R1	
	720CH	Switch Quantity Output 2	15	14	13	12	11	10	9	8	
			VY8	VY7	VY6	VY5	VY4	VY3	VY2	VY1	
			7	6	5	4	3	2	1	0	
			*	*	*	*	*	*	*	*	*
	720DH	Last Two Faults									
	720EH	Last Three Faults									
	720FH	Last Fault									
	7210H	Last Fault Output Frequency									
	7211H	Last Fault Output Current									
	7212H	Last Fault Bus Voltage									
	7213H	Last Fault Running Status									
	7214H	Last Fault Working Time									
	7215H	Set Acceleration Time									
	7216H	Set Deceleration Time									
	7217H	Cumulative length									
7218H	Not Used										
7219H	UP/DOWN Offset Frequency Symbol (0/1: +/-)										
7220H - 73FFH	Not Used										
Product Information 7500H - 75FFH	7500H	Performance Software Serial Number 1					Correspond to F12.22				
	7501H	Performance Software Serial Number 2					Correspond to F12.23				
	7502H	Function Software Serial Number 1					Correspond to F12.24				
	7503H	Function Software Serial Number 2					Correspond to F12.25				
	7504H	Keypad Software Serial Number 1					Correspond to F12.26				
	7505H	Keypad Software Serial Number 2					Correspond to F12.27				
	7506H	Product Serial Number 1					Correspond to F12.28				
	7507H	Product Serial Number 2					Correspond to F12.29				
	7508H	Product Serial Number 3					Correspond to F12.30				
7509H - 75FFH	Not Used										
Other	Not Used										

12.3.5 Data Frame Length

Number of read/write registers for PDU of RTU frame of MODBUS message falls into the scope between 1 and 16. As for different function codes, actual lengths of RTU frames are different. See Table 12-3 for details.

Table 12-3 RTU Length and Function Codes

Function Code (0x)	RTU frame length (byte)			Maximum Length (Byte)
	Request	Normal response	Abnormal response	
03	8	5+2N _r ^[4]	5	37
41 (06)	8	8	5	8
08	8	8	5	8

42 (10)	$9+2N_w$ ^[5]	8	5	41
---------	-------------------------	---	---	----

[4]: $N_r \leq 16$, indicates the number of registers requested to read;

[5]: $N_w \leq 16$, indicates the number of registers requested to write;

[6]: $N_w + N_r \leq 16$;

12.3.6 CRC Parity

CRC parity is with low byte in the front and high byte in the back.

Transmitting device calculates CRC value at first and attaches this value in sent message.

Receiving device will, upon receipt of CRC value, calculate it again and compare the calculated value with received CRC value. If they are not equal, it means that an error has occurred in transmitting process.

Calculation of CRC parity:

- (1) Define a CRC register and assign an initial value FFFFH.
- (2) Perform xor calculation for the first byte of the message to be sent, and value of CRC register, and put the result into CRC register. This starts from address code, without involving start bit and stop bit.
- (3) Draw and check LSB (least significant bit of CRC register).
- (4) If LSB is 1, all bits of CRC register will shift rightward by one bit and the most significant bit will be supplemented by 0. Perform xor calculation for CRC register value and A001H, and put the result in CRC register.
- (5) If LSB is 0, all bits of CRC register will shift rightward by one bit and the most significant bit will be supplemented by 0.
- (6) Repeat steps 3, 4 and 5, until 8 times of shifts have been completed.
- (7) Repeat steps 2, 3, 4, 5 and 6, and process next byte of the message to be sent, until all bytes of the message are processed.
- (8) Calculation completed. Content of CRC register is the value for CRC parity.
- (9) In a system where time and resource are limited, better to use the look-up table method to realize CRC parity.

CRC simple function is as follows (use C language for programming):

```
unsigned int CRC_Cal_Value(unsigned char *Data, unsigned char Length)
```

```
{
    unsigned int crc_value = 0xFFFF;
    int i = 0;
    while(Length--)
    {
        crc_value ^= *Data++;
        for(i=0;i<8;i++)
        {
            if(crc_value & 0x0001)
            {
                crc_value = (crc_value>>1)^ 0xa001;
            }
            else
            {
                crc_value = crc_value>>1;
            }
        }
    }
}
```

```
return(crc_value);
}
```

Contents above illustrate CRC parity theory. It takes a long time for execution with this method, especially when parity data is long. Therefore, use the following two look-up table methods for 16-bit and 8-bit controllers.

- CRC16 look-up table for 8-bit processor: finally returned result of this program is with high byte in the front, so please reverse it while sending.

```
const Uint8 crc_l_tab[256] = {
0x00,0xC1,0x81,0x40,0x01,0xC0,0x80,0x41,0x01,0xC0,0x80,0x41,0x00,0xC1,0x81,0x40,
0x01,0xC0,0x80,0x41,0x00,0xC1,0x81,0x40,0x00,0xC1,0x81,0x40,0x01,0xC0,0x80,0x41,
0x01,0xC0,0x80,0x41,0x00,0xC1,0x81,0x40,0x00,0xC1,0x81,0x40,0x01,0xC0,0x80,0x41,
0x00,0xC1,0x81,0x40,0x01,0xC0,0x80,0x41,0x01,0xC0,0x80,0x41,0x00,0xC1,0x81,0x40,
0x01,0xC0,0x80,0x41,0x00,0xC1,0x81,0x40,0x00,0xC1,0x81,0x40,0x01,0xC0,0x80,0x41,
0x00,0xC1,0x81,0x40,0x01,0xC0,0x80,0x41,0x01,0xC0,0x80,0x41,0x00,0xC1,0x81,0x40,
0x00,0xC1,0x81,0x40,0x01,0xC0,0x80,0x41,0x01,0xC0,0x80,0x41,0x00,0xC1,0x81,0x40,
0x01,0xC0,0x80,0x41,0x00,0xC1,0x81,0x40,0x00,0xC1,0x81,0x40,0x01,0xC0,0x80,0x41,
0x01,0xC0,0x80,0x41,0x00,0xC1,0x81,0x40,0x00,0xC1,0x81,0x40,0x01,0xC0,0x80,0x41,
0x00,0xC1,0x81,0x40,0x01,0xC0,0x80,0x41,0x01,0xC0,0x80,0x41,0x00,0xC1,0x81,0x40,
0x01,0xC0,0x80,0x41,0x00,0xC1,0x81,0x40,0x00,0xC1,0x81,0x40,0x01,0xC0,0x80,0x41,
0x01,0xC0,0x80,0x41,0x00,0xC1,0x81,0x40,0x00,0xC1,0x81,0x40,0x01,0xC0,0x80,0x41,
0x00,0xC1,0x81,0x40,0x01,0xC0,0x80,0x41,0x01,0xC0,0x80,0x41,0x00,0xC1,0x81,0x40
};
```

```
const Uint8 crc_h_tab[256] = {
0x00,0xC0,0xC1,0x01,0xC3,0x03,0x02,0xC6,0x06,0x07,0xC7,0x05,0xC5,0xC4,0x04,
0xCC,0x0C,0x0D,0xCD,0x0F,0xCF,0xCE,0x0E,0x0A,0xCA,0xCB,0x0B,0xC9,0x09,0x08,0xC8,
0xD8,0x18,0x19,0xD9,0x1B,0xDB,0xDA,0x1A,0x1E,0xDE,0xDF,0x1F,0xDD,0x1D,0x1C,0xDC,
0x14,0xD4,0xD5,0x15,0xD7,0x17,0x16,0xD6,0xD2,0x12,0x13,0xD3,0x11,0xD1,0xD0,0x10,
0xF0,0x30,0x31,0xF1,0x33,0xF3,0xF2,0x32,0x36,0xF6,0xF7,0x37,0xF5,0x35,0x34,0xF4,
0x3C,0xFC,0xFD,0x3D,0xFF,0x3F,0x3E,0xFE,0xFA,0x3A,0x3B,0xFB,0x39,0xF9,0xF8,0x38,
0x28,0xE8,0xE9,0x29,0xEB,0x2B,0x2A,0xEA,0xEE,0x2E,0x2F,0xEF,0x2D,0xED,0xEC,0x2C,
0xE4,0x24,0x25,0xE5,0x27,0xE7,0xE6,0x26,0x22,0xE2,0xE3,0x23,0xE1,0x21,0x20,0xE0,
0xA0,0x60,0x61,0xA1,0x63,0xA3,0xA2,0x62,0x66,0xA6,0xA7,0x67,0xA5,0x65,0x64,0xA4,
0x6C,0xAC,0xAD,0x6D,0xAF,0x6F,0x6E,0xAE,0xAA,0x6A,0x6B,0xAB,0x69,0xA9,0xA8,0x68,
0x78,0xB8,0xB9,0x79,0xBB,0x7B,0x7A,0xBA,0xBE,0x7E,0x7F,0xBF,0x7D,0xBD,0xBC,0x7C,
0xB4,0x74,0x75,0xB5,0x77,0xB7,0xB6,0x76,0x72,0xB2,0xB3,0x73,0xB1,0x71,0x70,0xB0,
0x50,0x90,0x91,0x51,0x93,0x53,0x52,0x92,0x96,0x56,0x57,0x97,0x55,0x95,0x94,0x54,
0x9C,0x5C,0x5D,0x9D,0x5F,0x9F,0x9E,0x5E,0x5A,0x9A,0x9B,0x5B,0x99,0x99,0x59,0x58,0x98,
0x88,0x48,0x49,0x89,0x4B,0x8B,0x8A,0x4A,0x4E,0x8E,0x8F,0x4F,0x8D,0x4D,0x4C,0x8C,
0x44,0x84,0x85,0x45,0x87,0x47,0x46,0x86,0x82,0x42,0x43,0x83,0x41,0x81,0x80,0x40
};
```

```
Uint16CRC(Uint8 * buffer, Uint8 crc_len)
```

```
{
    Uint8 crc_i,crc_lsb,crc_msb;
    Uint16 crc;
    crc_msb = 0xFF;
    crc_lsb = 0xFF;
    while(crc_len--)
    {
        crc_i = crc_lsb ^ *buffer;
```

```

    buffer++;
    crc_lsb = crc_msb ^ crc_l_tab[crc_i];
    crc_msb = crc_h_tab[crc_i];
}
crc = crc_msb;
crc = (crc << 8) + crc_lsb;
return crc;
}

```

- CRC16 look-up table for 16-bit processor: finally returned result of this program is with high byte in the front, so please reverse it while sending.

```

const Uint16 crc_table[256] = {
0x0000,0xC1C0,0x81C1,0x4001,0x01C3,0xC003,0x8002,0x41C2,0x01C6,0xC006
,0x8007,0x41C7,0x0005,0xC1C5,0x81C4,0x4004,0x01CC,0xC00C,0x800D,0x41CD
,0x000F,0xC1CF,0x81CE,0x400E,0x000A,0xC1CA,0x81CB,0x400B,0x01C9,0xC009
,0x8008,0x41C8,0x01D8,0xC018,0x8019,0x41D9,0x001B,0xC1DB,0x81DA,0x401A
,0x001E,0xC1DE,0x81DF,0x401F,0x01DD,0xC01D,0x801C,0x41DC,0x0014,0xC1D4
,0x81D5,0x4015,0x01D7,0xC017,0x8016,0x41D6,0x01D2,0xC012,0x8013,0x41D3
,0x0011,0xC1D1,0x81D0,0x4010,0x01F0,0xC030,0x8031,0x41F1,0x0033,0xC1F3
,0x81F2,0x4032,0x0036,0xC1F6,0x81F7,0x4037,0x01F5,0xC035,0x8034,0x41F4
,0x003C,0xC1FC,0x81FD,0x403D,0x01FF,0xC03F,0x803E,0x41FE,0x01FA,0xC03A
,0x803B,0x41FB,0x0039,0xC1F9,0x81F8,0x4038,0x0028,0xC1E8,0x81E9,0x4029
,0x01EB,0xC02B,0x802A,0x41EA,0x01EE,0xC02E,0x802F,0x41EF,0x002D,0xC1ED
,0x81EC,0x402C,0x01E4,0xC024,0x8025,0x41E5,0x0027,0xC1E7,0x81E6,0x4026
,0x0022,0xC1E2,0x81E3,0x4023,0x01E1,0xC021,0x8020,0x41E0,0x01A0,0xC060
,0x8061,0x41A1,0x0063,0xC1A3,0x81A2,0x4062,0x0066,0xC1A6,0x81A7,0x4067
,0x01A5,0xC065,0x8064,0x41A4,0x006C,0xC1AC,0x81AD,0x406D,0x01AF,0xC06F
,0x806E,0x41AE,0x01AA,0xC06A,0x806B,0x41AB,0x0069,0xC1A9,0x81A8,0x4068
,0x0078,0xC1B8,0x81B9,0x4079,0x01BB,0xC07B,0x807A,0x41BA,0x01BE,0xC07E
,0x807F,0x41BF,0x007D,0xC1BD,0x81BC,0x407C,0x01B4,0xC074,0x8075,0x41B5
,0x0077,0xC1B7,0x81B6,0x4076,0x0072,0xC1B2,0x81B3,0x4073,0x01B1,0xC071
,0x8070,0x41B0,0x0050,0xC190,0x8191,0x4051,0x0193,0xC053,0x8052,0x4192
,0x0196,0xC056,0x8057,0x4197,0x0055,0xC195,0x8194,0x4054,0x019C,0xC05C
,0x805D,0x419D,0x005F,0xC19F,0x819E,0x405E,0x005A,0xC19A,0x819B,0x405B
,0x0199,0xC059,0x8058,0x4198,0x0188,0xC048,0x8049,0x4189,0x004B,0xC18B
,0x818A,0x404A,0x004E,0xC18E,0x818F,0x404F,0x018D,0xC04D,0x804C,0x418C
,0x0044,0xC184,0x8185,0x4045,0x0187,0xC047,0x8046,0x4186,0x0182,0xC042
,0x8043,0x4183,0x0041,0xC181,0x8180,0x4040};

```

```

Uint16 CRC16(Uint16 *msg , Uint16 len){
    Uint16 crcL = 0xFF , crcH = 0xFF;
    Uint16 index;
    while(len--){
        index = crcL ^ *msg++;
        crcL = ((crc_table[index] & 0xFF00) >> 8) ^ (crcH);
        crcH = crc_table[index] & 0xFF;
    }
    return (crcH<<8) | (crcL);
}

```

12.3.7 Abnormal Information Response

Master wants to receive a normal response after it sends a request to slave. Inquiry of master can possibly result in the following four response situations:

- If slave has received a request without communication error and can handle inquiry normally, slave will return a normal response;
- If slave has not received a request due to communication error, slave can not return information. Slave will be deemed as overtime;
- If slave has received a request but detected a communication error (for example parity, address, frame error), it will not return a response. Slave will be deemed as overtime;
- If slave has received a request without communication error but can not handle it (example: request to read a register which does not exist and so on), it will return an abnormal response to report actual situation of error to master.

An abnormal response message has two fields different from the normal response:

- Function code field: in normal response, slave copies original request function code from appropriate function code field. MSB of all function codes is zero. In abnormal response, MSB of slave function code is 1. Abnormal response **function code = normal function code +0x80**
- Data Field: A slave can return data in data field in normal response and return abnormal code in abnormal response. See Table 12-4 for definitions of exception codes.

Table 12-4 Definitions of Exception Codes

Exception Code	Name	Definitions
01H	Illegal function	Function code received by slave exceeds configured scope (refer to 12.3.3 Function Code).
02H	Illegal data address	Data address received by slave (inverter) is not a permitted one; especially, combination of start address and transmission length of register is invalid (refer to 12.3.4 Allocation of Register Address).
03H	Illegal data frame	As detected by slave (inverter), inquiry data frame length or CRC parity is incorrect.
04H	Slave fault	Unrecoverable error occurs when slave (inverter) tries to execute require operation. Possible causes include logic error and failure to write EEPROM.
05H	Data exceeding the range	Data received by slave (inverter) exceeds corresponding register scope: minimum - maximum.
06H	Parameter: read only	Present register is read only and can not be written.
07H	Parameter: not modified during running	Inverter is in running status. Present register can not be written. If necessary, please stop inverter at first.
08H	Parameter: password protection	Present register is password protected.

12.4 Protocol Description

12.4.1 Definitions of Interframe and Intraframe Time Intervals

A complete MODBUS message includes not only required data unit, but also start and end

marks. Therefore, as indicated in Figure 12-1 or Figure 12-3, an idle level with transmission time equal to or greater than 3.5 characters is defined as start or end mark, and transmission will be deemed as abnormal if there is an idle level with transmission time greater than 1.5 characters during message transmission.

Specific start-end or abnormal interval time has something to do with bit rate (refer to Table 12-5). If bit rate is 9,600 bps, with sampling period of 1ms, then start-end interval is an idle level greater than or equal to 4ms ($3.5 \times 10 / 9600 = 3.64 \approx 4$), the interval of exceptional data is the idle level with interval time among bits of one data frame greater than or equal to 2ms ($1.5 \times 10 / 9600 = 1.56 \approx 2$) but smaller than 4ms (idle level between normal data bits less than or equal to 1 ms).

Table 12-5 Checklist of Time Interval and Bit Rate (when $t_{\text{modify}}=1$ ms)

Bit rate (bps)	Start-end interval $T_{\text{interval}} (t_{\text{modify}})$	Abnormal interval $T_{\text{abnormal}} (t_{\text{modify}})$	Remarks
4800	8	4	Normal frame permits the idle point level $\leq 3\text{ms}$; when an idle level $\geq 8\text{ms}$, it means the end of a data frame.
9600	4	2	Normal frame permits the idle point level $\leq 1\text{ms}$; when an idle level $\geq 4\text{ms}$, it means the end of a data frame.
19200	2	1	Normal frame permits idle point level $< 1\text{ms}$; when an idle level $\geq 2\text{ms}$, it means the end of a data frame.
Higher	1	1	An idle level of 1ms means the end of a data frame.

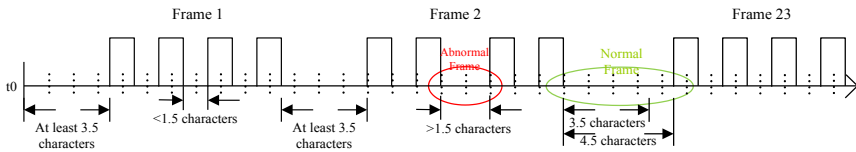

Figure 12-3 Correct and Incorrect Data Frames

12.4.2 Data Frame Processing

After receiving a data frame, the system shall process it first to judge whether it is a legal frame. Then, check whether data is correct and perform corresponding processing. If the received frame is illegal, inverter will not turn data; if the received frame is legal but incorrect, it will turn corresponding fault information frame.

Legal frame: meet address (inverter or broadcast) and length (not less than 3) applications.

Correct frame: a correct frame is a legal frame, of which corresponding memory address is correct, memory content is in defined scope and can be processed for the time being.

12.4.3 Modbus Response Delay

Define the time interval from receipt of a valid data frame [7] (data on RS-485 network, different from command sent by keyboard), to data learning, and then to starting data return, as response delay (set through F10.04). Since a standard protocol has defined start and end marks, there must be response delay, at least 3.5 character time interval +1ms (485 protocol chip stable time, t_{w2}), and minimum time interval has something to do with bit rate. If bit

rate is 9600 bps, minimum response delay shall be 5 ms ($3.5 \times 10 / 9600 + 1 = 4.64 \approx 5$).

If communication data involves EEPROM operation, actual time interval will be extended.

[7]: Valid data frame: sent by external master (other than keypad) to inverter, and function code, data length and CRC are correct.

In Figure 12-4, data sending section (t_s), sending end mark section (t_{w1}), 75176 forwarding waiting section (t_{w2}), data return section (t_r) and 75176 receipt section (t_{w3}).

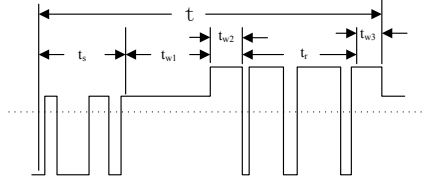

Figure 12-4 Time Sequence Learning of Complete Data Frame

12.4.4 Communication Overtime

Communication interval Δt refers to the period from previous receipt of a valid data frame by slave (inverter) to its receipt again. If Δt is greater than set time (see F10.03; this function is disabled if it is set as 0), this is called “communication overtime”.

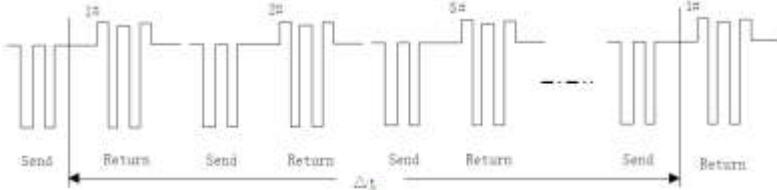

Figure 12-5 485 Network Link Data

12.5 Example

1) Forward Running of inverter

Send: 01 41 70 00 00 01 E6 C5

Return: 01 41 70 00 00 01 E6 C5 (Normal)

Return: 01 C1 04 70 53 (When abnormal, assuming that slave fails)

	Send		Normal return		Abnormal return	
*	Frame header	≥ 3.5 idle characters				
1	Address	01	Address	01	Address	01
2	Function Code	41	Function Code	41	Function Code	C1
3	Register Address Hi	70	Register Address Hi	70	Exception Code	04 (assumption)
4	Register Address Lo	00	Register Address Lo	00	CRC Parity Lo	70
5	Register Value Hi	00	Register Value Hi	00	CRC Parity Hi	53
6	Register Value Lo	01	Register Value Lo	01		
7	CRC Parity Lo	E6	CRC Parity Lo	E6		
8	CRC Parity Hi	C5	CRC Parity Hi	C5		
*	Frame End	≥ 3.5 idle characters				

2) Inverter stops

Send: 01 41 70 0000 07 66 C7

Return: 01 41 70 0000 07 66 C7 (Normal)

Return: 01 C1 04 70 53 (When abnormal, assuming that slave fails)

	Send	Normal return		Abnormal return		
*	Frame Header	≥3.5 idle characters				
1	Address	01	Address	01	Address	01
2	Function Code	41	Function Code	41	Function Code	C1
3	Register Address Hi	70	Register Address Hi	70	Exception Code	04 (assumption)
4	Register Address Lo	00	Register Address Lo	00	CRC Parity Lo	70
5	Register Value Hi	00	Register Value Hi	00	CRC Parity Hi	53
6	Register Value Lo	07	Register Value Lo	07		
7	CRC Parity Lo	66	CRC Parity Lo	66		
8	CRC Parity Hi	C7	CRC Parity Hi	C7		
*	Frame End	≥3.5 idle characters				

3) Change the setting frequency (for example 50.00 Hz/1388 H) (F00.04=7)

Send: 01 41 70 15 13 88 3B 97

Return: 01 41 70 15 13 88 3B 97 (Normal)

Return: 01 C1 04 70 53 (When abnormal, assuming that slave fails)

	Send	Normal return		Abnormal return		
*	Frame Header	≥3.5 idle characters				
1	Address	01	Address	01	Address	01
2	Function Code	41	Function Code	41	Function Code	C1
3	Register Address Hi	70	Register Address Hi	70	Exception Code	04 (assumption)
4	Register Address Lo	15	Register Address Lo	15	CRC Parity Lo	70
5	Register Value Hi	13	Register Value Hi	13	CRC Parity Hi	53
6	Register Value Lo	88	Register Value Lo	88		
7	CRC Parity Lo	3B	CRC Parity Lo	3B		
8	CRC Parity Hi	97	CRC Parity Hi	97		
*	Frame End	≥3.5 idle characters				

4) Read last fault information (read F19.00 - F19.05)

Send: 01 03 13 00 00 06 C1 4C

Return: 01 03 0C 00 11 00 00 00 00 01 2C 00 00 00 00 53 5B (Normal)

Return: 01 83 04 40 F3 (When abnormal, assuming that slave fails)

	Send	Normal return		Abnormal return		
*	Frame Header	≥3.5 idle characters				
1	Address	01	Address	01	Address	01
2	Function Code	03	Function Code	03	Function Code	83
3	Initial Address Hi	13	Number of Bytes	0C	Exception Code	04 (assumption)

Send		Normal return		Abnormal return		
4	Initial Address Lo	00	Register Value Hi (F19.00)	00	CRC Parity Lo	40
5	Number of Registers Hi	00	Register Value Lo (F19.00)	11	CRC Parity Hi	F3
6	Number of Registers Lo	06	Register Value Hi (F19.01)	00		
7	CRC Parity Lo	C1	Register Value Lo (F19.01)	00		
8	CRC Parity Hi	4C	Register Value Hi (F19.02)	00		
9			Register Value Lo (F19.02)	00		
10			Register Value Hi (F19.03)	01		
11			Register Value Lo (F19.03)	2C		
12			Register Value Hi (F19.04)	00		
13			Register Value Lo (F19.04)	00		
14			Register Value Hi (F19.05)	00		
15			Register Value Lo (F19.05)	00		
16			CRC Parity Lo	53		
17			CRC Parity Hi	5B		
*	Frame End	≥3.5 idle characters				

5) Check whether lines work

Send: 01 08 00 00 AA 55 5E 94

Return: 01 08 00 00 AA 55 5E 94 (Normal)

Return: 01 88 04 47 C3 (When abnormal, assuming that slave fails)

Send		Normal return		Abnormal return		
*	Frame Header	≥3.5 idle characters				
1	Address	01	Address	01	Address	01
2	Function	08	Function	08	Function Code	88
3	Sub-Function Code Hi	00	Sub-Function Code Hi	00	Exception Code	04 (assumption)
4	Sub-Function Code Lo	00	Sub-Function Code Lo	00	CRC Parity Lo	47
5	Data Hi	AA	Data Hi	AA	CRC Parity Hi	C3
6	Data Lo	55	Data Lo	55		
7	CRC Parity Lo	5E	CRC Parity Lo	5E		
8	CRC Parity Hi	94	CRC Parity Hi	94		
*	Frame End	≥3.5 idle characters				

6) Change carrier frequency (F00.23) to 4.0 kHz. (Since such function codes are expected to be saved in EEPROM usually after change, 0x06 is used hereby).

Send: 01 06 00 17 00 28 39 D0

Return: 01 06 00 17 00 28 39 D0 (Normal)

Return: 01 86 04 43 A3 (When abnormal, assuming that slave fails)

Send		Normal return		Abnormal return		
*	Frame Header	≥3.5 idle characters				
1	Address	01	Address	01	Address	01

	Send		Normal return		Abnormal return	
2	Function Code	06	Function Code	06	Function Code	86
3	Register Address Hi	00	Register Address Hi	00	Exception Code	04 (assumption)
4	Register Address Lo	17	Register Address Lo	17	CRC Parity Lo	43
5	Register Value Hi	00	Register Value Hi	00	CRC Parity Hi	A3
6	Register Value Lo	28	Register Value Lo	28		
7	CRC Parity Lo	39	CRC Parity Lo	39		
8	CRC Parity Hi	D0	CRC Parity Hi	D0		
*	Frame End	≥3.5 idle characters				

13 660V inverter Commisioning Instructions

13.1 Wiring

R/S/T is connected with grid input 660VAC. U/V/W is connected with motor. PE is connected with grid PE.

Only external brake unit is applied for 660V inverter. Details refer to the diagram below.

Please check the input power cables, motor power cables and brake unit power cables before power on.

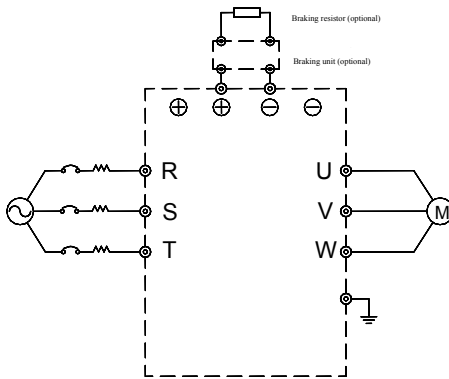

Figure 13-1 660V inverter wiring diagram

13.2 Power on

After checking wiring is correct and the inverter is power-on motor parameters (F01 group) should be set properly. The motor parameters must be according to the parameters on the motor nameplate. After setting inverter starts stationary and rotational autotuning, respectively for asynchronous motor.

The difference between default parameters for 660V inverter and chapter 6 function code default values is shown as below.

F04.01	Start Frequency	0.75Hz
F04.02	Start Frequency Retention time	2
F04.06	Pre-Excitation Current	200.0%
F04.07	Pre-Excitation	1.00s
F05.10	V/F Rotor Voltage Drop Compensation Gain	0.0%

F05.11	V/F Slip Compensation Gain	0.0%
F06.01	Speed Integral Time Constant ASR_T1	1.000s
F06.03	Speed Integral Time Constant ASR_T2	2.000s
F07.07	Overvoltage Stall Control Voltage	120%
F15.31	Operation Voltage of Dynamic Brake	120%
F15.38	Deadband Compensation Mode	1: Compensation Mode 1

Attention

1. 660V inverter parameter default values is associated with inverter rated voltage, please set inverter rated voltage to 660V.
2. Control mode SVC is not applied for 660V inverter.
3. 660V inverter application please refers to chapter 7 function code in detail.

Appendix I Multi-Functional IO Expansion Card (EC-IO-A1)

I.1 General

EC-IO-A1 card is used for EM600 control terminal expansion, including the following resources:

Item	Specification	Description
Input	4 Numeric Multi-function Inputs	
	1 Analog Voltage Signal Input	Support -10V - +10V voltage input or PT100/PT1000 temperature sensor
Output	1 Numeric Signal Output	

I.2 Installation Instructions

- Install IO expansion card into expansion slot EC-B (make sure it is installed and buckled properly).
- Disassemble or install IO expansion card only after inverter is powered off.

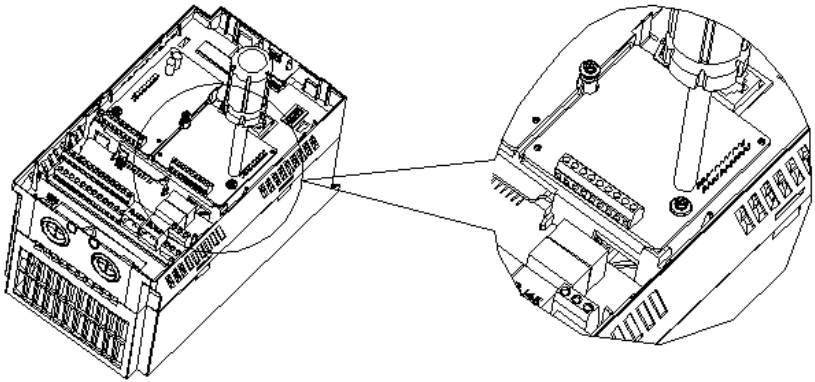

Figure 1 Installation of IO Expansion Card

Point I/O expansion card at interface and location hole of expansion slot, and fix them with screws.

- Figures of real objects are as follows:



- | | | |
|-----------------------------|------------------------|----------------------------|
| Elevation | | Back Elevation |
| 1. DIP Switch 1 | 2. DIP Switch 2 | 3. Analog Signal Interface |
| 4. Numeric Signal Interface | 5. Screw Location Hole | 6. Inverter Interface |

I.3 Expansion Terminal Function

Table 1 IO Expansion Card Terminal Function

Mode	Terminal No.	Terminal	Terminal Function
Auxiliary Power Supply	24V-COM	+24V Power Supply	Provide working power supply for numeric input and output terminals
	PLC	Common Multi-function Input Terminal	Default setting: connecting to 24V power supply When driving numeric input terminal with external power supply, disconnect it from 24V terminal and connect it to external power supply.
Numeric Input	X8	Multi-function Input Terminal 8	Optocoupler isolation, compatible with bipolar input of NPN and PNP Input impedance: 4.5 kΩ Input voltage range: 9 – 30 V See Table 3-17
	X9	Multi-function Input Terminal 9	
	X10	Multi-function Input Terminal 10	
	X11	Multi-function Input Terminal 11	
Multi-Function Output	Y3-COM	OC Output Terminal	Optocoupler isolation, OC output Maximum output voltage: DC48V Output current: 50 mA
Analog Input	AI4-GND	Analog Input Terminal 4	Input range: DC -10V - +10V; voltage input mode is selected by switch S2 on IO expansion card. Input impedance: Voltage mode 1 MΩ

Mode	Terminal No.	Terminal	Terminal Function
	PT-GND	Temperature Sensor Input	PT100 and PT1000 Temperature Sensor Input Control mode is selected through switches S2 and S2 on IO expansion card.

Table 2 DIP Switch of IO Expansion Card

S1	S2	Function								
_____	<table border="1"> <tr> <td>DIF</td> <td>PT</td> </tr> <tr> <td><input checked="" type="checkbox"/></td> <td><input type="checkbox"/></td> </tr> </table>	DIF	PT	<input checked="" type="checkbox"/>	<input type="checkbox"/>	AI4 Voltage Input, Enabled PT Input, Disabled				
DIF	PT									
<input checked="" type="checkbox"/>	<input type="checkbox"/>									
<table border="1"> <tr> <td>100</td> <td>1000</td> </tr> <tr> <td><input checked="" type="checkbox"/></td> <td><input type="checkbox"/></td> </tr> </table>	100	1000	<input checked="" type="checkbox"/>	<input type="checkbox"/>	<table border="1"> <tr> <td>DIF</td> <td>PT</td> </tr> <tr> <td><input type="checkbox"/></td> <td><input checked="" type="checkbox"/></td> </tr> </table>	DIF	PT	<input type="checkbox"/>	<input checked="" type="checkbox"/>	AI4 Voltage Input, Disabled PT input is through temperature sensor PT100
100	1000									
<input checked="" type="checkbox"/>	<input type="checkbox"/>									
DIF	PT									
<input type="checkbox"/>	<input checked="" type="checkbox"/>									
<table border="1"> <tr> <td>100</td> <td>1000</td> </tr> <tr> <td><input type="checkbox"/></td> <td><input checked="" type="checkbox"/></td> </tr> </table>	100	1000	<input type="checkbox"/>	<input checked="" type="checkbox"/>	<table border="1"> <tr> <td>DIF</td> <td>PT</td> </tr> <tr> <td><input type="checkbox"/></td> <td><input checked="" type="checkbox"/></td> </tr> </table>	DIF	PT	<input type="checkbox"/>	<input checked="" type="checkbox"/>	AI4 Voltage Input, Disabled PT input is through temperature sensor PT1000
100	1000									
<input type="checkbox"/>	<input checked="" type="checkbox"/>									
DIF	PT									
<input type="checkbox"/>	<input checked="" type="checkbox"/>									

Appendix II General Encoder Expansion Card (PG Card)

II.1 General

User shall purchase appropriate PG card from SINEE when using closed loop vector control.

- Configuration:

EM600 inverter is equipped with multiple general PG cards. User shall select PG card based on encoder output form. Models of PG cards are listed in the table below:

Model No.	Description	Encoder interface
EC-PG-O1	open collector output encoder complementary push-pull output encoders encoder with voltage output	6PIN connection terminal
EC-PG-O2	open collector output encoder complementary push-pull output encoders encoder with voltage output With frequency dividing output and PG output is open collector.	Input: 6PIN connection terminal Output: 4PIN connection terminal
EC-PG-D1	Differential output encoder (long line drive encoder) Wire-saved UVW differential output encoder	9PIN connection terminal
EC-PG-D3	Differential output encoder (long line drive encoder) Wire-saved UVW differential output encoder With frequency dividing output and PG output is open collector.	Input: 9PIN connection terminal Output: 4PIN connection terminal
EC-PG-U1	UVW differential output encoder	DB15 female connector
EC-PG-R1	Rotary transformer output encoder	DB9 female connector

II.2 Installation Instructions

- Install PG card into expansion slot EC-A (make sure it is installed and buckled properly).
- Disassemble or install PG card only after inverter is powered off.

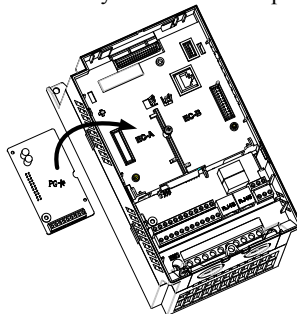

Figure 2 Installation of PG Card

- Figures of real objects are as follows:



EC-PG-O1



EC-PG-D1



EC-PG-D3



EC-PG-U1



EC-PG-R1

II.3 Definition and Instruction of Specification and Wiring Terminal Signal

Table 3 Instructions of Terminal Signal of OC Input PG Card (EC-PG-O1)

No.	Terminal Signal	Description
1	PE	Shielded wiring terminal
2	12V	Power output voltage: 12 V±5% Maximum output current: 200 mA
3	COM	Common terminal of input power and signal
4	A	Encoder signal input, single end input Maximum response frequency 80 kHz
5	B	
6	Z	

Table 4 Instruction of Terminal Signal of OC output with frequency dividing PG Card (EC-PG-O2)

No.	Terminal Signal	Description
1	PE	Shielded wiring terminal
2	12V	Power output voltage: 12V±5% Maximum output current: 200 mA
3	COM	Common terminal of input power and signal
4	A	Encoder signal input, single input Maximum response frequency 80 kHz
5	B	
6	Z	
7	ZO	OC (open collector) output
8	BO	
9	AO	
10	COM	Common terminal of input power and signal

Table 5 Instructions of Terminal Signal of Differential Input PG Card (EC-PG-D1)

No.	Terminal Signal	Description
1	PE	Shielded wiring terminal
2	5V	Power output voltage: 5V±5% Maximum output current: 300 mA

3	COM	Common terminal of input power and signal
4	Z	Encoder signal input, differential input Differential signal amplitude ≤ 7 V, maximum response frequency 300 kHz
5	/Z	
6	B	
7	/B	
8	A	
9	/A	

Table 6 Instructions of Terminal Signal of Differential Input with frequency dividing OC output PG Card (EC-PG-D3)

序号	端子信号	说明
1	PE	Shielded wiring terminal
2	5V	Power output voltage: $5V \pm 5\%$ Maximum output current: 300 mA
3	COM	Common terminal of input power and signal
4	Z	Encoder signal input, differential input Differential signal amplitude ≤ 7 V, maximum response frequency 300 kHz
5	/Z	
6	B	
7	/B	
8	A	
9	/A	
10	ZO	OC (open collector) output
11	BO	
12	AO	
13	COM	Common terminal of input power and signal

Table 7 Instructions of Terminal Signal of UVW Differential Input PG Card (EC-PG-U1)

No.	Terminal Signal	Description
1	A	Encoder signal input, differential input Differential signal amplitude ≤ 7 V, maximum response frequency 300 kHz
2	/A	
3	B	
4	/B	
5	Z	
6	/Z	
7	U	Encoder signal input, differential input Differential signal amplitude ≤ 7 V
8	/U	
9	V	
10	/V	
11	W	
12	/W	
13	5V	Power output voltage: $5V \pm 5\%$ Maximum output current: 300 mA
14	COM	Common terminal of input power and signal
15	-	

Table 8 Instructions of Terminal Signal of Rotary Transformer PG Card (EC-PG-R1)

No.	Terminal Signal	Description
1	EXCLO	Rotary transformer excitation signal 7 Vrms, 10 kHz
2	EXC	
3	SIN	Rotary transformer feedback signal 3.5±0.175 Vrms, 10 kHz
4	SINLO	
5	COS	
6	-	
7	-	
8	-	
9	COSLO	

II.4 Swtichs for Frequency Dividing

Swtich can change the ratio of frequency dividing. Maximum ratio is 510 and minimum is no dividng.

Swtich 1# is bit0

Swtich 2# is bit1

Swtich 3# is bit2

Swtich 4# is bit3

Swtich 5# is bit4

Swtich 6# is bit5

Swtich 7# is bit6

Swtich 8# is bit7

‘On’ means binary digit ‘1’ and ‘off’ means binary digit ‘0’.

The ration of frequency dividing = binary digit x 2

swtichs	Binary digit	Ration of frequency dividing
<p>ON</p> <p>1 2 3 4 5 6 7 8</p>	00000000	None
<p>ON</p> <p>1 2 3 4 5 6 7 8</p>	00000001	2
<p>ON</p> <p>1 2 3 4 5 6 7 8</p>	00000010	4

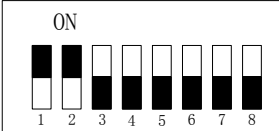
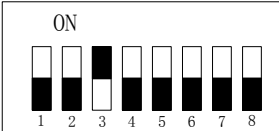
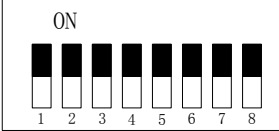
	<p>0000011</p>	<p>6</p>
	<p>00000100</p>	<p>8</p>
<p>...</p>	<p>...</p>	<p>...</p>
	<p>11111111</p>	<p>510</p>

Appendix III Profibus-DP Expansion Card (EC-CM-P1)

III.1 General

Communication card EC-CM-P1 is defined as PROFIBUS-DP slave communication card and used to connect EM600 inverter to PROFIBUS-DP network.

Main features:

- Support PZD control data exchange.
- Support PKW access to inverter parameters.
- Support the user diagnosis function.
- Automatic detection of communication rate, up to 12 Mbps.

III.2 Installation Instructions

- Install Profibus-DP expansion card into expansion slot EC-B (make sure it is installed and buckled properly).
- Disassemble or install Profibus-DP expansion card only after inverter is powered off.

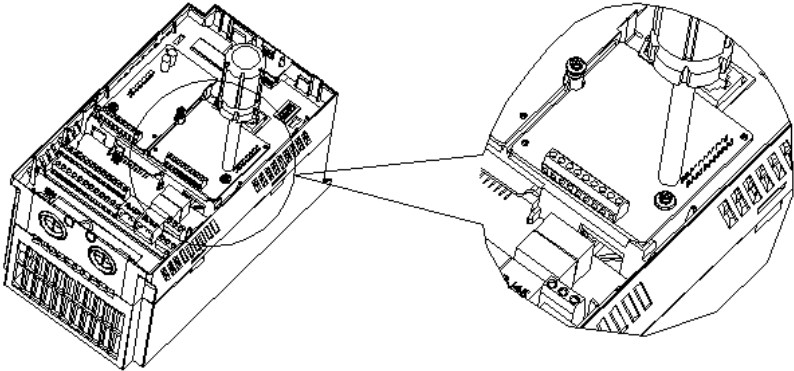

Point Profibus-DP expansion card at interface and location hole of expansion slot, and fix them with screws.

- Figures of real objects are as follows:

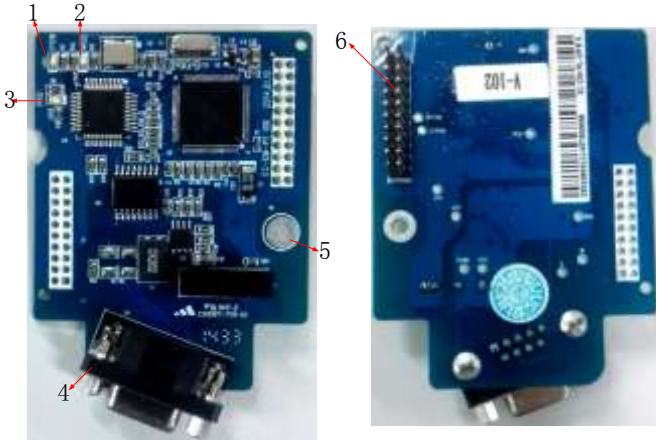

Elevation

Back Elevation

- | | | |
|--------------------------|------------------------|-----------------------|
| 1. POWER Indicator | 2. Modbus Indicator | 3. Profibus Indicator |
| 4. Profibus-DP Interface | 5. Screw Location Hole | 6. Inverter Interface |

III.3 Expansion Terminal Function

Table 9 Profibus-DP Expansion Card Terminal Function

Mode	Terminal No.	Terminal	Description
Profibus-DP Communication Terminal	3	Data A	Signal Line (Anode)
	4	RTS	Request for Sending Signal
	5	PGND	Data Signal Ground
	6	P5V	Power
	8	Data B	Signal Line (Cathode)

Table 10 Indicator of of Profibus-DP Expansion Card (Terminal is DB9)

LED Indicator	Display Function	Description
POW	Power Indicator	The expansion card is connected to inverter normally and this indicator is normally on after inverter is powered on.
MOD	Profibus-DP Expansion Card and Inverter Communication Indicator	“Normally on” status means that DP expansion card and inverter communicate with each other normally. “Off” status means that DP expansion card and inverter fail to communicate with each other.
PRO	Profibus-DP Expansion Card and Profibus Bus Connection Indicator	“Normally on” status means that DP expansion card and bus communicate with each other normally. “Off” status means that DP expansion card and bus fail to communicate with each other.

Table 11 DIP Switch of Profibus-DP Expansion Card

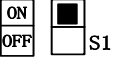
Switch	Function
 S1	Choose terminal resistor

Appendix IV CANopen Expansion Card (EC-CM-C1)

IV.1 General

Communication card EC-CM-P1 is defined as CANOPEN slave communication card and used to connect EM600 inverter to CANOPEN network.

Main features:

- It supports Node Guard protocol and master can use this function to view device status.
- It supports Heartbeat protocol, with which slave reports present status to master regularly.
- It supports NMT network management protocol, with which inverter receives message for inverter status control by master and changes its own communication status.
- SDO only supports accelerated sending mechanism, up to 4 bytes in transmission, and can be used to read and write device parameters.
- PDO supports 4 groups and user may select 1 group randomly; this can be used to transmit the data required for real time transmission in transmission communication process, up to 4 bytes for each frame.

IV.2 Installation Instructions

- Install CANopen expansion card into expansion slot EC-B (make sure it is installed and buckled properly).
- Disassemble or install CANopen expansion card only after inverter is powered off.

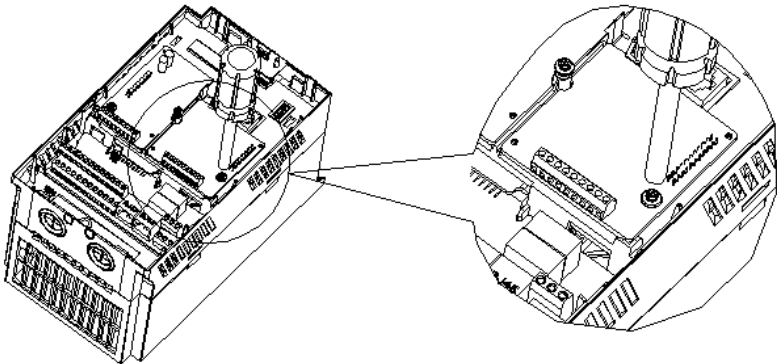

Figure 3 CANopen Expansion Card Installation

Point CANopen expansion card at interface and location hole of expansion slot, and fix them with screws.

- Figures of real objects are as follows:



Elevation



Back Elevation

- | | | |
|-----------------------|----------------------|------------------------|
| 1. POWER Indicator | 2. RUN Indicator | 3. ERR Indicator |
| 4. READY Indicator | 5. CANopen Interface | 6. Screw Location Hole |
| 7. Inverter Interface | | |

IV.3 Expansion Terminal Function

Table 12 CANopen Expansion Card Terminal Function

Mode	Terminal No.	Terminal	Terminal Function
CANopen Communication Terminal	1	CANH	Signal Line (Anode)
	2	CANL	Signal Line (Cathode)
	3	PGND	Signal Ground

Table 13 CANopen Expansion Card Indicator

Communication Card	READY (Green)	ERR (Red)	RUN (Green)
Initialization Status	ON	OFF	OFF
Operation Status	ON	OFF	Slow flicker
Operation Status	ON	OFF	ON
Stop Status	ON	OFF	Rapid Flicker
Modbus Fault	ON	Slow flicker	OFF
CANopen Fault	ON	ON	OFF
Factory Inspection	ON	ON	ON

Table 14 Flicker of CANopen Expansion Card Indicator

Definition of Flicker	Illustration
Rapid Flicker	
Slow flicker	

Table 15 DIP Switch of CANopen Expansion Card

S2	Function
ON OFF S1	Select a matching end resistor

Appendix V DeviceNet Expansion Card (EC-CM-D1)

V.1 General

Communication card EC-CM-D1 is defined as DeviceNet slave communication card and used to connect EM600 inverter to DeviceNet network.

Main features:

1. Support connection mode “Group 2 only” of DeviceNet communication protocol, and support I/O polling data exchange.
2. I/O mapping supports up to 16-byte input and 16-byte output.
3. Support three communication rates via DeviceNet bus, respectively 125 kbps, 250 kbps and 500 kbps.
4. Support direct setting of node address and communication rate on inverter.
5. Automatically obtain power from inverter.
6. Monitor inverter in real time based upon high-speed communication port of SINEE Modbus communication protocol.

V.2 Installation Instructions

- Install DeviceNet card into expansion slot EC-B (make sure it is installed and buckled properly).
- Disassemble or install DeviceNet card only after inverter is powered off.

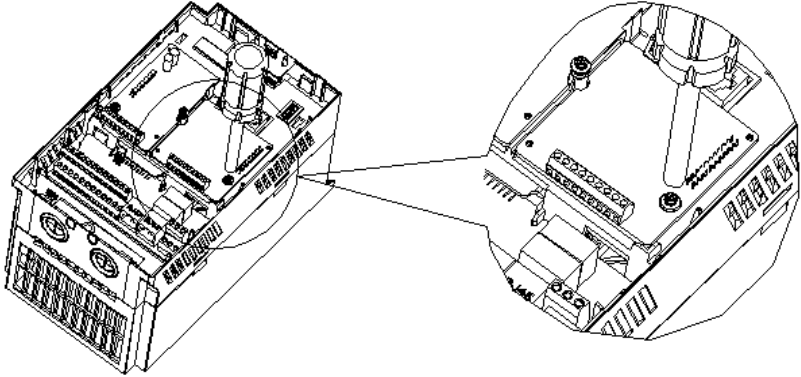
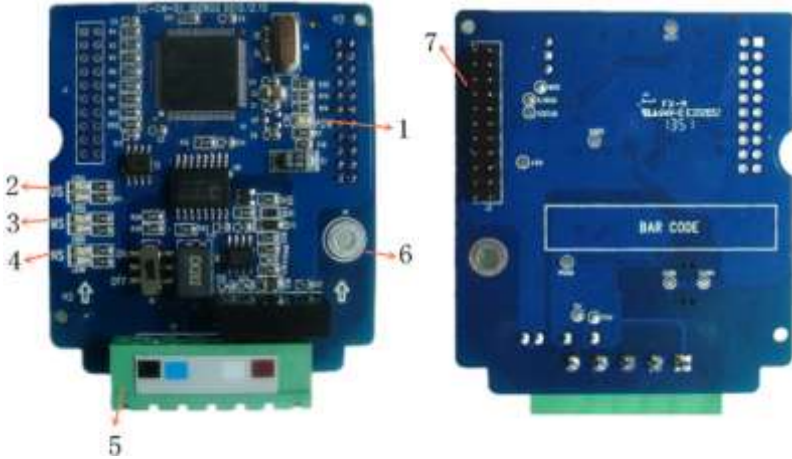

Figure 4 Installation of DeviceNet Expansion Card

Point DeviceNet expansion card at interface and location hole of expansion slot, and fix them with screws.

- Figures of real objects are as follows:



Elevation

Back Elevation

- | | | |
|-----------------------|------------------------|------------------------|
| 1. POWER Indicator | 2. US Indicator | 3. MS Indicator |
| 4. NS Indicator | 5. DeviceNet Interface | 6. Screw Location Hole |
| 7. Inverter Interface | | |

V.3 Expansion Terminal Function

Table 16 DeviceNet Expansion Card Terminal Function

Mode	Terminal No.	Terminal	Terminal Function
DeviceNet Communication Terminal	Red	V+	DC24V
	White	CANH	Signal Line (Anode)
	-	S	Shielding Layer
	Blue	CANL	Signal Line (Cathode)
	Black	V-	Power Ground

Table 17 DeviceNet Expansion Card Indicators

Indicator	LED Status	Display	Solution
POWER	Off	No Power Supply	Check whether power of communication card works normally
	On	Normal Power Supply	No need to do anything
NS	Off	No Power Supply	Check whether power of communication card works normally
	Green Lamp Flicker	Communication Card Already Connected Online, but Connection to Master Not Established	1. Configure communication card to master scan list 2. Re-download configuration data to master
	Green Lamp On	Communication Card Already Connected Online and Connection to	No need to do anything

Indicator	LED Status	Display	Solution
		Master Established	
	Red Lamp Flicker	Communication Card Already Connected Online and Single I/O Communication Overtime	<ol style="list-style-type: none"> 1. Configure communication card to master scan list 2. Re-download configuration data to master
	Red Lamp On	MACID Detection Failure; No Network Power Supply Bus-off Bus-off	<ol style="list-style-type: none"> 1. Confirm that there is no repeated node address on the network 2. Check if network power supply is normal 3. Confirm whether communication rate and wiring are normal
MS	Off	No Power Supply	Check whether power of communication card works normally
	Green Lamp Flicker	Wait for I/O Data	Switch PLC to RUN status
	Green Lamp On	Normal I/O Data	No need to do anything
	Red Lamp Flicker	Mapping Error	Configure communication card or power on inverter again
	Red Lamp On	Hardware Error	Return for repairing
US	Off	No Power Supply	Check if power of communication card works normally
	Green Lamp Flicker	Wait for Inverter to Return Data	Confirm that communication card and inverter are connected together normally
	Green Lamp On	Normal Data with Inverter	No need to do anything
	Red Lamp Flicker	Communication Overtime	Confirm that communication card and inverter are connected together normally
	Red Lamp On	Communication Failure	Power it on again

Table 18 DIP Switch of DeviceNet Expansion Card

S2 S2	Function
	Select a matching end resistor