

Preface

Thank you for choosing SINEE's EM730/EM730E series inverter.

Document No.: 31010183

Release time: June 2020

Version: 100

The EM730/EM730E series inverter is a high-reliable and small-sized universal inverter launched by SINEE. EM730 supports three-phase AC asynchronous motors, while EM730E supports permanent magnet synchronous motors. They support a variety of drive control technologies, such as the vector VF (VVF) control and speed sensorless vector control (SVC); speed output and torque output; and Wi-Fi access and background software debugging.

Features of the EM730/EM730E series inverter:

- Support debugging by the mobile phone APP or monitoring of the inverter status;
- Support Wi-Fi module or serial port access;
- Rich and convenient PC background software functions;
- No need for derating at the ambient temperature of 50 °C;
- Support “one-key shuttle” for fast and accurate speed adjustment;
- Perfect protections: Protections against the short circuit, overcurrent, overvoltage, overload, overheating, etc.

Before using the EM730/EM730E series inverter, please read this manual carefully and keep it properly.

While connecting the inverter to motor for the first time, please select the motor type (asynchronous or synchronous) correctly and set the motor nameplate parameters: rated power, rated voltage, rated current, rated frequency, rated speed, motor connection, rated power factor, etc.

Since we are committed to continuously improving our products and product data, the data provided by us may be modified without prior notice.

For the latest changes and contents, please visit www.sinee.cn.

Safety precautions

Safety definition: Safety precautions are divided into the following two categories in this manual:



Danger: The dangers caused by nonconforming operations may include serious injuries and even deaths.



Warning: The danger caused by nonconforming operations, including moderate or minor injuries and equipment damage.

During the installation, commissioning and maintenance, please read this chapter carefully, and follow the safety precautions herein. Our company will not be liable for any injury or loss arising from nonconforming operations.

Precautions

Before installation:



Danger

1. Do not install the product in the case of water in the package or missing or damaged components found in unpacking!
2. Do not install the product in the case of inconsistency between the actual product name and identification on the outer package.



Warning

1. Handle the controller with care; otherwise, it may be damaged!
2. Never use the inverter damaged or with some parts missing; otherwise, injuries may be caused!
3. Do not touch the components of the control system with your hands; otherwise, there is a danger of static damage!

During installation:



Danger

1. Please install the inverter on a metal retardant object (e.g. metal) and keep it away

from combustibles; otherwise, a fire may be caused!

2. Do not loosen the fixing bolts of components, especially those with red marks!



Warning

1. Never make wire connectors or screws fall into the inverter; otherwise, the inverter may be damaged!
2. Install the inverter in a place with little vibration and exposure to direct sunlight.
3. When the inverter is installed a relatively closed cabinet or space, pay attention to the installation gap to ensure the effects of heat dissipation.

During wiring:



Danger

1. Follow the instructions in this manual, and appoint professional and electrical engineering personnel to complete wiring; otherwise, unexpected dangers may be caused!
2. The inverter and power supply must be separated by a circuit breaker (recommendation: greater than or equal to and closest to twice the rated current); otherwise, a fire may be caused!
3. Before wiring, make sure that the power supply is in the zero energy status; otherwise, electric shock may be caused!
4. Never connect the input power supply to the output terminals (U, V, W) of the inverter. Pay attention to the marks of wiring terminals, and connect wires correctly! Otherwise, the inverter may be damaged!
5. Make the inverter grounded correctly and reliably according to the standards; otherwise, electric shock and fire may be caused!



Warning

1. Make sure that the lines meet the EMC requirements and local safety standards. For wire diameters, refer to the recommendations. Otherwise, an accident may occur!
2. Never connect the braking resistor directly between the DC bus+ and -terminal. Otherwise, a fire may be caused!
3. Tighten the terminals with a screwdriver of specified torque; otherwise, there is a risk of fire.
4. Never connect the phase-shifting capacitor and LC/RC noise filter to the output circuit.
5. Do not connect the electromagnetic switch and electromagnetic contactor to the output circuit. Otherwise, the overcurrent protection circuit of the inverter will be enabled. In severe cases, the inverter may be subject to internal damage.
6. Do not dismantle the connecting cable inside the inverter; otherwise, internal damage may be caused to the inverter.

Before power-on:

 **Danger**

1. Make sure that the voltage level of the input power supply is consistent with the rated voltage of the inverter; and the input terminals (R, S, T) and output terminals (U, V, W) of the power supply are connected correctly. Check whether there is short circuit in the peripheral circuits connected to the inverter and whether all connecting lines are tightened; otherwise, the inverter may be damaged!
2. The withstand voltage test has been performed to all parts of the inverter, so it is not necessary to carry it out again. Otherwise, an accident may be caused!

 **Warning**

1. The inverter must not be powered on until it is properly covered; otherwise, electric shock may be caused!
2. The wiring of all peripheral accessories must be in line with the instructions in this manual. All wires should be connected correctly according to the circuit connections in this manual. Otherwise, an accident may occur!

After power-on:

 **Danger**

1. Never touch the inverter and surrounding circuits with wet hands; otherwise, electric shock may occur!
2. If the indicator is not ON and the keyboard has no response after power-on, immediately turn off the power supply. Never touch the inverter terminals (R, S, T) and the terminals on the terminal block with your hands or screwdriver; otherwise, electric shock may be caused. Upon turning off the power supply, contact our customer service personnel.
3. At the beginning of power-on, the inverter automatically performs a safety test to external strong current circuits. Do not touch the inverter terminals (U, V, W) or motor terminals; otherwise, electric shock may be caused!
4. Do not disassemble any parts of the inverter while it is powered on.

 **Warning**

1. When parameter identification is required, please pay attention to the danger of injury during motor rotation; otherwise, an accident may occur!
2. Do not change the parameters set by the inverter manufacturer without permission; otherwise, the inverter may be damaged!

During operation:

 **Danger**

1. Do not touch the cooling fan, radiator and discharge resistor to feel the temperature; otherwise, burns may be caused!
2. Non-professional technicians must not test signals when the controller is in operation; otherwise, personal injury or equipment damage may be caused!

 **Warning**

1. Prevent any object from falling into the inverter in operation; otherwise, the inverter may be damaged!
2. Do not start or stop the inverter by turning on or off the contactor; otherwise, the inverter may be damaged!

During maintenance:

 **Danger**

1. Never carry out repair and maintenance in the live state; otherwise, electric shock may be caused!
2. Maintenance of the inverter must be carried out 10 min after the main circuit is powered off and the display interface of the keyboard is disabled; otherwise, the residual charge in the capacitor will do harm to the human body!
3. Personnel without professional training are not allowed to repair and maintain the inverter; otherwise, personal injury or inverter damage may be caused!
4. The parameters must be set after the inverter is replaced. Plugs in all interfaces must be operated in the power-off status!
5. The synchronous motor generates electricity while rotating. Inverter maintenance and repair must be performed 10 min after the power supply is turned off and the motor stops running; otherwise, electric shock may be caused!

Precautions

Motor insulation inspection

When the motor is used for the first time or after long-term storage or subject to regular inspection, its insulation should be checked to prevent the inverter from damage caused by failure of the motor winding insulation. During the insulation inspection, the motor must be disconnected from the inverter. It is recommended to use a 500V megohmmeter. The measured insulation resistance must not be less than 5 MΩ.

Thermal protection of motor

If the motor used does not match the rated capacity of the inverter, especially when the rated power of the inverter is greater than that of the motor, the motor must be protected by adjusting the motor protection parameters of the inverter or installing a thermal relay in front of the motor.

Operation above power frequency

This inverter can provide the output frequency of 0.00Hz to 600.00Hz/0.0Hz to 3000.0Hz. When the motor needs to operate above the rated frequency, please consider the capacity of the mechanical device.

About motor heat and noise

Since the inverter outputs PWM waves, containing some harmonics, the temperature rise, noise and vibration of the motor will be slightly more than those in operation at the power frequency.

Presence of voltage-dependent device or capacitor increasing the power factor on output side

The inverter outputs PWM waves. If there is a capacitor increasing the power factor or voltage-dependent resistor for lightning protection on the output side, the inverter may be subjected to instantaneous overcurrent and even damage. Do not use these devices.

Use beyond rated voltage

The EM730/EM730E series open-loop vector inverter should not be used beyond the allowable working voltage range specified in this manual; otherwise, the components inside the inverter are prone to damage. If necessary, use the appropriate step-up or step-down device for voltage transformation.

Lightning impulse protection

The inverter of this series is equipped with a lightning overcurrent protector, which has certain capabilities in self-protection against induced lightning. Where lightning strikes occur frequently, a protective device should be added in front of the inverter.

Altitude and derating

In areas with an altitude of more than 1,000 m, where heat dissipation of the inverter is poor due to thin air, derating is required (derating by 1% per 100 m altitude increase to maximum 3,000 m; for ambient temperature above 50°C, derating by 1.5% per 1°C temperature rise to maximum 60°C). Contact us for technical advice.

Precautions for scrapping of inverter

Burning of the electrolytic capacitors of the main circuit and printed circuit board may result in explosion, and burning of plastic parts may generate toxic gases. Please dispose of the controller as a kind of industrial waste.

Contents

Preface	1
Safety precautions	2
Precautions.....	2
Precautions.....	5
Chapter 1 Overview	10
1.1 Model and Specification of EM730/EM730E Series Inverter	10
1.2 Detailed Introduction to Running Status of EM730/EM730E series Inverter.....	13
Chapter 2 Installation	19
2.1 Product check	19
2.2 Outline dimensions and installation dimensions.....	20
2.3 Installation Site Requirements and Management	24
2.4 Installation Direction and Space	25
Chapter 3 Wiring.....	26
3.1 Connection of Peripheral Device.....	26
3.2 Wiring of Main Circuit Terminal.....	27
3.3 Wiring of Control Circuit Terminal	39
3.4 Extension wiring of keyboard.....	47
3.5 Connection test	47
Chapter 4 KEYBOARD OPERATIONS.....	48
4.1 Keyboard Functions	48
4.2 Operation Mode of Keyboard with Digital Tube Display.....	49
4.3 Protection Monitoring	54
4.4 Operation Monitoring.....	54
4.5 Run/Stop.....	55
4.6 Other Warning Prompts	56
Chapter 5 Trial run	57

5.1 Inverter Commissioning Process	57
5.2 Confirmation before Power-on	58
5.3 Inverter Status Confirmation after Power-on.....	58
5.4 Precautions for Application Macro Setting.....	58
5.5 Start and Stop Control	59
5.6 Common Process Parameters of Inverter.....	62
5.7 Motor Parameter Identification	63
Chapter 6 Function Code Table	64
6.1 Description of Function Code Table.....	64
6.2 Table of functional parameters	66
Chapter 7 Function Code Details.....	129
7.1 Basic Function Parameter Group of F00 Group	129
7.2 Motor 1 parameter group of F01 group	147
7.3 Function Parameter Group of Input Terminal of F02 Group	152
7.4 Function Parameter Group of Output Terminal of F03 Group.....	166
7.5 Start/Stop Control Parameter Group of F04 Group	177
7.6 VF Control Parameter Group of F05 Group	185
7.7 Vector Control Parameter Group of F06 Group.....	191
7.8 F07 protection parameter group	199
7.9 Multi-segment Speed and Simple PLC Parameter Group of F08 Group	207
7.10 PID Function Parameter Group of F09 Group.....	217
7.11 Communication Function Parameter Group of F10 Group.....	231
7.12 User-selected Parameter Group of F11 Group.....	236
7.13 Keyboard and Display Function Parameter Group of F12 Group	238
7.14 Torque Control Parameter Group of F13 Group.....	245
7.15 Parameter Group of Motor 2 of F14 group.....	250
7.16 Auxiliary Function Parameter Group of F15 Group	253
7.17 F16 customized function parameter group	265
7.18 Virtual I/O Function Parameter Group of F17 Group	272
7.19 Monitoring Parameter Group of F18 Group.....	276

7.20 F19 protection record parameter group	279
7.21 F27 winding and unwinding application macro parameter group.....	282
Chapter 8 Motor Parameter Self-identification.....	298
8.1 Motor Parameter Self-identification	298
8.2 Precautions before Self-identification	299
8.3 Self-identification Steps	300
Chapter 9 Protection/Warning Solutions	301
9.1 Protection content.....	301
9.2 Protection analysis.....	306
9.3 Daily Maintenance of Inverter.....	310
9.4 Instructions for Inverter Warranty	311
Chapter 10 Select accessories	313
10.1 Braking Resistor	313
10.2 Braking unit.....	314
10.3 Wi-Fi module.....	316
Chapter 11 MODBUS Communication Protocol.....	317
11.1 Applicable scope.....	317
11.2 Interface mode.....	317
11.3 Protocol Format	317
11.4 Protocol Description	339
11.5 Examples	342

Chapter 1 Overview

1.1 Model and Specification of EM730/EM730E Series Inverter

- Rated voltage of power supply:

Three-phase AC 340-460V, three-phase/single-phase AC 200V-240V;

- Applicable motor: Three-phase AC asynchronous motor (EM730) and permanent magnet synchronous motor (EM730E).

The model and rated output current of EM730/EM730E series inverter are as shown in Table 1-1.

Table 1-1 EM730/EM730E Series Inverter

Rated voltage of power supply	Model	Applicable motor power (kW)	Heavy-duty rated output current (A)	Light-duty rated output current (A)
Single-phase/three-phase AC 200V~240V	EM730/EM730E-0R4-2B	0.4	2.8	3.2
	EM730/EM730E-0R7-2B	0.75	4.8	5.0
	EM730/EM730E-1R5-2B	1.5	8	8.5
	EM730/EM730E-2R2-2B	2.2	10	11.5
Three-phase AC 340~460V	EM730/EM730E-0R7-3B	0.75	2.5	3
	EM730/EM730E-1R5-3B	1.5	4.2	4.6
	EM730/EM730E-2R2-3B	2.2	5.6	6.5
	EM730/EM730E-4R0-3B	4.0	9.4	10.5
	EM730/EM730E-5R5-3B	5.5	13	15.7
	EM730/EM730E-7R5-3B	7.5	17	20.5
	EM730/EM730E-011-3B	11	25	28
	EM730/EM730E-015-3B	15	32	36
	EM730/EM730E-018-3B	18.5	38	41.5
	EM730/EM730E-022-3B	22	45	49
	EM730/EM730E-030-3/3B	30	60	70
	EM730/EM730E-037-3/3B	37	75	85
	EM730/EM730E-045-3	45	90	105
	EM730/EM730E-055-3	55	110	134
	EM730/EM730E-075-3	75	150	168
	EM730/EM730E-090-3	90	176	200
EM730/EM730E-110-3	110	210	235	
EM730/EM730E-132-3	132	253	290	

	EM730/EM730E-160-3	160	304	340
--	--------------------	-----	-----	-----

- ★ Correct selection of the inverter: The rated output current of the inverter is greater than or equal to the rated current of the motor, taking into account the overload capacity.
- ★ The difference between the rated power of the inverter and that of the motor is usually recommended not to exceed two power segments.
- ★ When a high-power inverter is provided with a low-power motor, the motor parameters must be entered accurately to prevent the motor from damage as a result of overload.

The technical specifications of the EM730/EM730E series inverter are shown in Table 1-2.

Table 1-2 Technical Specifications of EM730/EM730E Series Inverter

Item		Specification
Power supply	Rated voltage of power supply	Three-phase 340V-10% to 460V+10%, Single-phase/three-phase 200V-10% to 240V+10%; 50-60Hz $\pm 5\%$; voltage unbalance rate: <3%
Output	Maximum output voltage	The maximum output voltage is the same as the input power voltage.
	Rated output current	Continuous output of 100% rated current
	Maximum overload current	150% heavy-duty rated current: 60s; 180% heavy-duty rated current: 10s; 200% heavy-duty rated current: 2s 120% light-duty rated current: 60s; 150% light-duty rated current: 10s; 180% light-duty rated current: 2s
Basic control functions	Drive mode	V/F control (VVF); speed sensorless vector control (SVC)
	Input mode	Frequency (speed) input, torque input
	Start and stop control mode	Keyboard, control terminal (two-line control and three-line control), communication
	Frequency control range	0.00~600.00Hz/0.0~3000.0HZ
	Input frequency resolution	Digital input: 0.01Hz/0.1Hz Analog input: 0.1% of maximum frequency
	Speed control range	1:50 (VVF), 1:200 (SVC)
	Speed control	Rated synchronous speed $\pm 0.2\%$

	accuracy	
	Acceleration and deceleration time	0.01 s to 600.00 s / 0.1 s to 6,000.0 s / 1 s to 60,000 s
	Voltage/frequency characteristics	Rated output voltage: 20% to 100%, adjustable Reference frequency: 1Hz to 600Hz/3,000Hz
	Torque boost	Fixed torque boost curve Any V/F curve is acceptable.
	Starting torque	150%/1Hz (VVF) 150%/0.25Hz (SVC)
	Torque control accuracy	±5% rated torque (SVC)
	Self-adjustment of output voltage	When the input voltage changes, the output voltage will basically remain unchanged.
	Automatic current limit	Output current is automatically limited to avoid frequent overcurrent trips.
	DC braking	Braking frequency: 0.01 to maximum frequency Braking time: 0~30S Braking current: 0% to 150% rated current
	Signal input source	Communication, multi-speed, analog, etc.
Input and output function	Reference power supply	10V/20mA
	Terminal control power	24V/100mA
	Digital input terminal	5-channel digital multi-function input: X1~X5 X5 can be used as the high-speed pulse input (max. 100kHz).
	Analog input terminal	2-channel analog inputs: One (AI1) voltage source: -10 to 10V input; One channel (AI2): 0 to 10V input voltage or 0 to 20mA input current optional;

	Digital output terminal	Multi-function output of one open collector and one relay Maximum output current of the collector: 50 mA; Relay contact capacity: 250VAC/3A or 30VDC/1A, EA-EC: normally open; EB-EC: normally closed
	Analog output terminal	One multi-function analog terminal output M1: 0-10V/0-20mA multi-function analog output terminal
Keyboard	LED display	The LED digital tube displays relevant information about the inverter.
Protection	Protective Function	Short circuit, overcurrent, overvoltage, undervoltage, phase loss, overload, overheat, load loss, external protection, etc.
Use conditions	Location	Indoor, at an altitude of less than 1 km, free of dust, corrosive gases and direct sunlight. When the altitude is higher than 1km, it is derated by 1% per 100m. The maximum allowable altitude is 3km.
	Applicable environment	-10℃ to +50℃, 5% to 95%RH (no condensation). When the ambient temperature exceeds 50 ℃, it needs to be derated by 3% per 1 ℃ temperature rise. The maximum allowable ambient temperature is 60 ℃.
	Vibration	Less than 0.5g
	Storage environment	-40℃ ~ +70℃
	Installation method	Wall-mounted or installed in the cabinet
Levels of protection		IP20/IP21 (with plastic baffle)
Cooling method		Forced air cooling

1.2 Detailed Introduction to Running Status of EM730/EM730E series Inverter

1.2.1 Working status of inverter

The working status of EM730/EM730E series inverter is divided into: parameter setting status, normal running status, jog running status, self-learning running status, stop status, jog stop status and protection status.

- Parameter setting status: After being powered on and initialized, the inverter will be in the standby status with no trip protection or start command, and have no output.

- Normal running status: Upon receiving a valid start command (from the keyboard, control terminal and communication), the inverter will have the output based on the set input requirements, driving the motor to rotate.
- Jog running status: This is enabled by the keyboard, external terminal or communication, driving the motor to rotate at the jog input speed.
- Self-learning running status: This is enabled by the keyboard, detecting relevant parameters of the motor in the stationary or rotating status.
- Stop status: It is a process for the output frequency to decrease to zero according to the set deceleration time in the case of invalid operating commands.
- Jog stop status: It is a process for the output frequency to decrease to zero according to the jog deceleration time in the case of invalid jog operating commands.
- Protection status: Refer to the inverter status in the case of any protection.

1.2.2 Running mode of inverter

The running mode of the inverter refers to the control law of the inverter to drive the motor to rotate at the required speed and torque. The running mode includes:

- General open-loop space vector control-VVF control: suitable for applications where the speed is not changing fast and there are not high requirements for the accuracy of rotating speed, and most AC motor drives.
- Speed sensorless vector control-SVC control: advanced speed estimation algorithm, involving open-loop vector control and high control accuracy but no encoder.

1.2.3 Set mode of inverter

The set mode of the inverter refers to the physical quantity that is taken as the controlled target when the inverter drives a motor.

- Speed setting mode with the motor speed as controlled target

Digital setting, analog input setting, high-speed pulse input setting, communication setting, digital potentiometer setting, process PID setting, simple PLC setting or multi-segment speed setting can be performed separately or in a mixed manner. Fig. 1-1to Fig. 1-4 detail various input modes of the EM730/EM730E series inverter by speed setting.

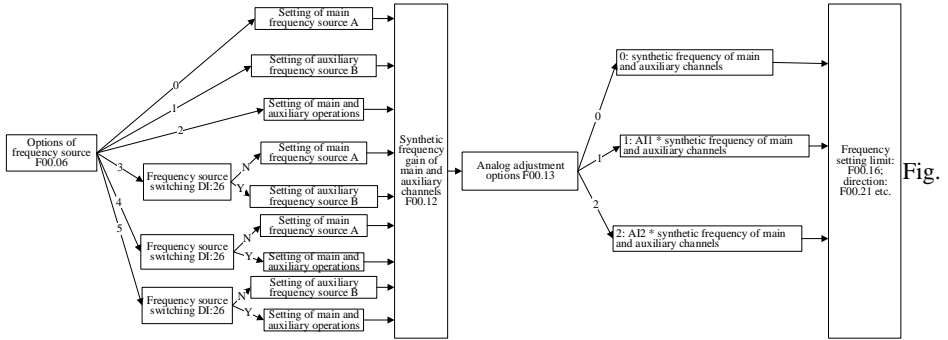

1-1 Schematic Diagram of Speed Input Mode

As shown in Fig. 1-1, speed setting of EM730/EM730E series inverter is mainly divided into the setting of main frequency source A setting (referred to as “main A”), setting of auxiliary frequency source B (referred to as “auxiliary B”), and setting of main and auxiliary operations. The final settings are made by simply adjustment and limitation (e.g. upper frequency limit, maximum frequency limit, direction limit, frequency hopping limit). See Figs. 1-2 to 1-4 for setting details.

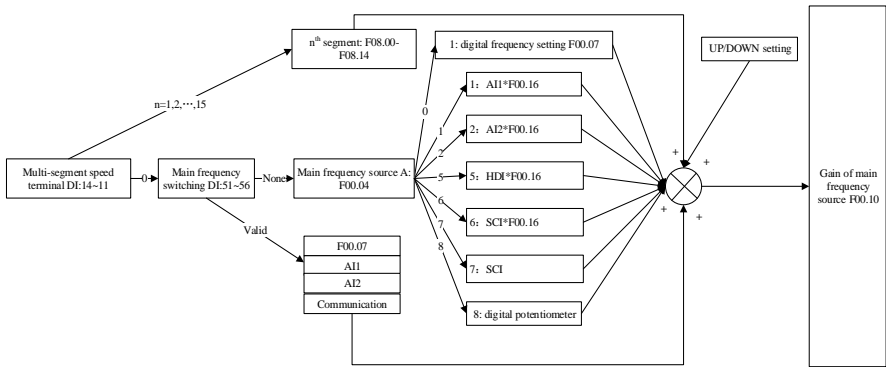

Fig. 1-2 Schematic diagram of Setting of Main Frequency Source A

As shown in Fig. 1-2, it is necessary to comprehensively consider the digital terminal setting and its status during the setting of the main frequency source A. Depending on the terminal settings, multi-segment speed operation can be performed or digital, analog, pulse or communication settings can be applied directly.

If the terminals are unavailable, the current setting channel is determined by the function code F00.04, and final settings are obtained through UP/DOWN setting calculation.

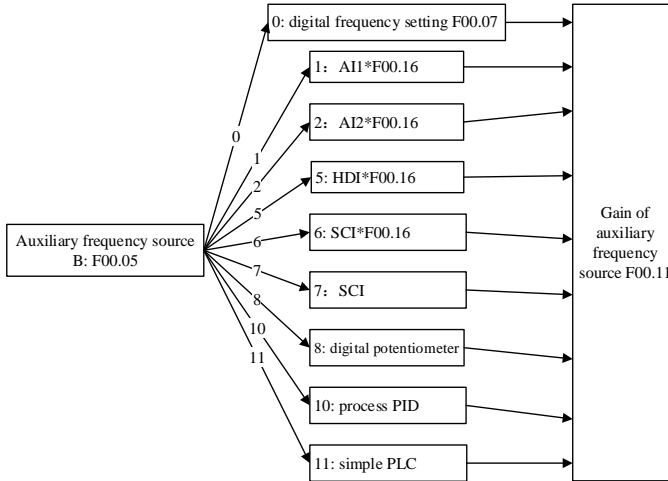

Fig. 1-3 Schematic Diagram of Setting of Auxiliary Frequency Source B

As shown in Fig. 1-3, the current setting channel is determined directly by the function code F00.05 during the setting of the auxiliary frequency source B, and the process PID and simple PLC can be involved in the setting.

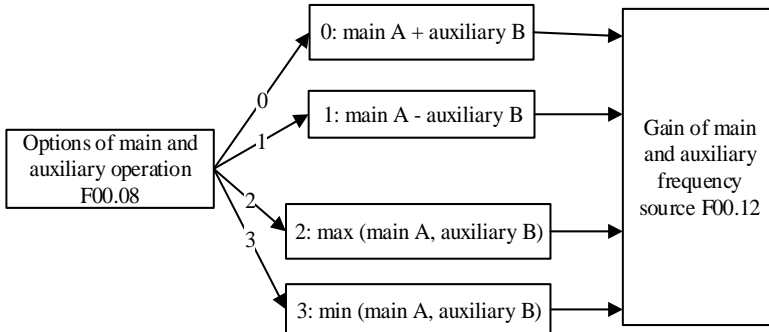

Fig. 1-4 Schematic Diagram of Setting of Main and Auxiliary Operations

As shown in Fig. 1-4, main and auxiliary operations are divided into four types, in which main and auxiliary settings are valid.

- Torque setting mode with the motor current as controlled target

The digital setting, analog input setting, high-speed pulse input setting, communication setting, digital potentiometer setting or multi-segment torque setting can be applied. Fig. 1-5 details the input modes of EM730/EM730E series inverters with the set torque.

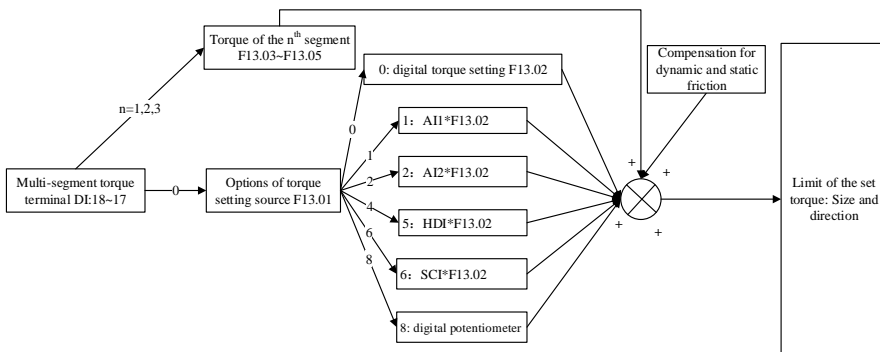

Fig. 1-5 Schematic Diagram of Torque Input Mode

★: The jog speed setting mode is superior to other setting modes. That is, when the control terminals FJOG and RJOG are enabled, the inverter will automatically change to the jog speed setting mode, regardless of the current setting mode.

1.2.4 Operation method of inverter

The operation method of the inverter refers to the operating conditions for the inverter to enable the running status. It includes: keyboard operation, terminal operation and communication operation. Terminal operation is divided into two-line control (RUN, F/R) and three-line control (RUN, F/R, Xi (i=1-5)) (change the definition of Xi to three-line operation stop control). The control logic of this operation method is shown in Fig. 1-6 (take the NPN input mode as an example).

K1	K2	Running command
0	0	Reverse
0	1	Forward
1	0	Stop
1	1	Stop

0: closed 1: disconnected

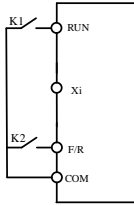

(a) Two-line running mode 0 (F00.03=0)

K1	K2	Running command
0	0	Stop
0	1	Forward
1	0	Reverse
1	1	Stop

0: closed 1: disconnected

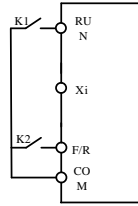

(b) Two-line running mode 1 (F00.03=1)

RUN	Forward button
F/R	Reverse button
Xi	Stop button

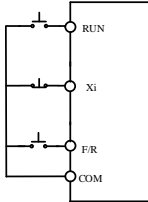

(c) Three-line running mode 0 (F00.03=2)

RUN	Run button
Xi	Stop button
F/R	
1	Forward
0	Reverse

0: closed 1: disconnected

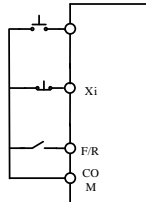

(d) Three-line running mode 1 (F00.03=3)

Fig. 1-6 Control Logic Diagram of Terminal Operation

Chapter 2 Installation

2.1 Product check

 Danger
<ul style="list-style-type: none"> ● Never install the inverter damaged or with some parts missing. Otherwise, injuries may be caused.

When you get the product, please check it according to Table 2-1.

Table2-1 Check Items

Item to be confirmed	Confirming methods
Check whether the product is consistent with the order.	Check the nameplate on the side face of the inverter.
Check whether any part is damaged.	Check the overall appearance for damage caused in transportation.
Check whether the fastened parts (e.g. screws) are loose.	If necessary, check the product with a screwdriver.

In the case of any defect, contact the agent or our Marketing Department.

- **Nameplate**

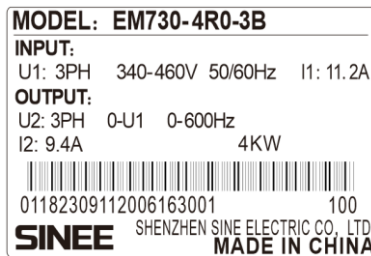

- **Description of inverter model**

EM730-4R0-3B

Product series:
M730:EM730 inverter
EM730E:EM730E inverter

Power (kW) of the supporting motor
of inverter
Example: 4R0: 4.0kW
0.37:37kW

B: Built-in braking unit

Input power voltage level:
2: Single/three-phase 220V
3: Three-phase 380V

2.2 Outline dimensions and installation dimensions

EM730/EM730E series inverters involve 25 specifications, two types of appearance and ten installation sizes, as shown in Fig. 2-1 and Table 2-2.

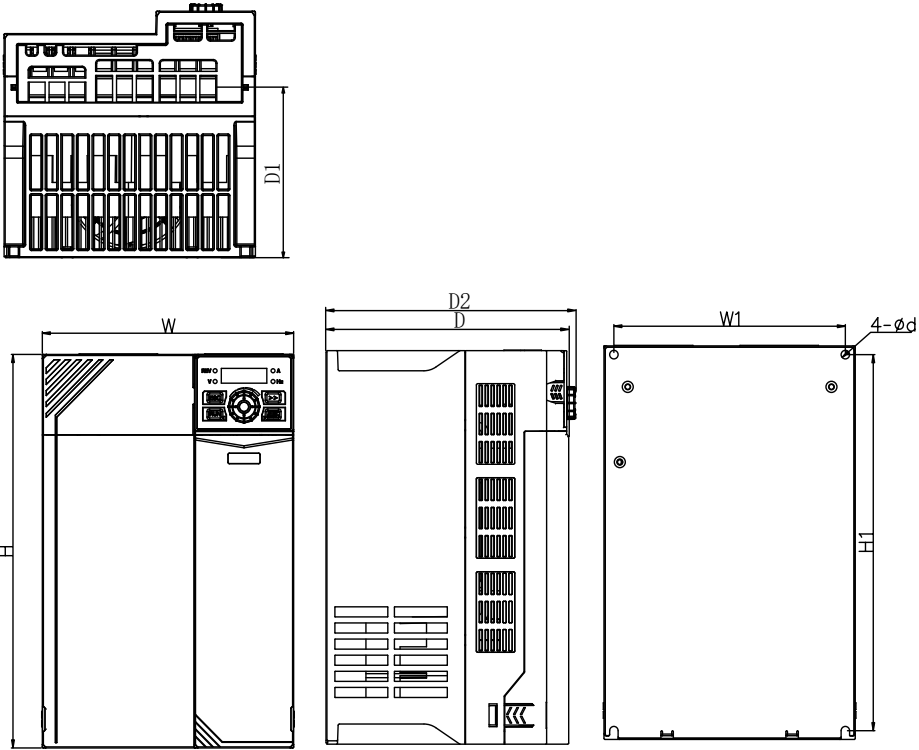

(a) Appearance of EM730/EM730E-0R7-3B to EM730/EM730E-022-3B inverters

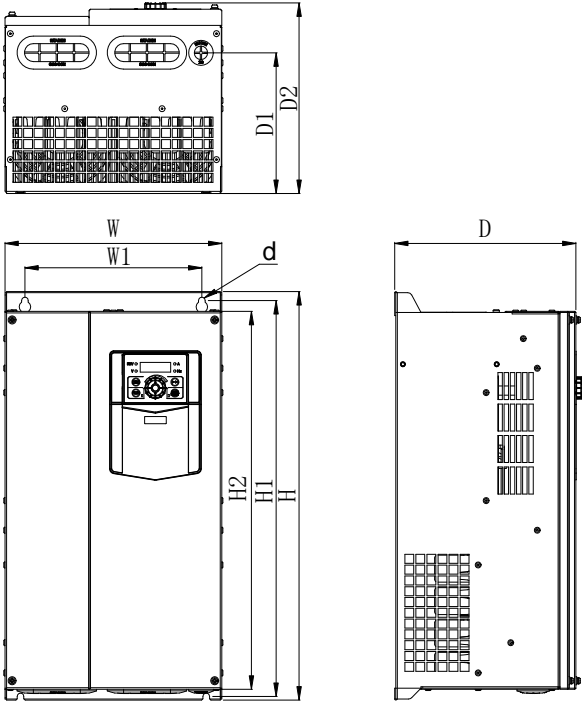

(b) Appearance of EM730/EM730E-030-3B to EM730/EM730E-075-3 inverters

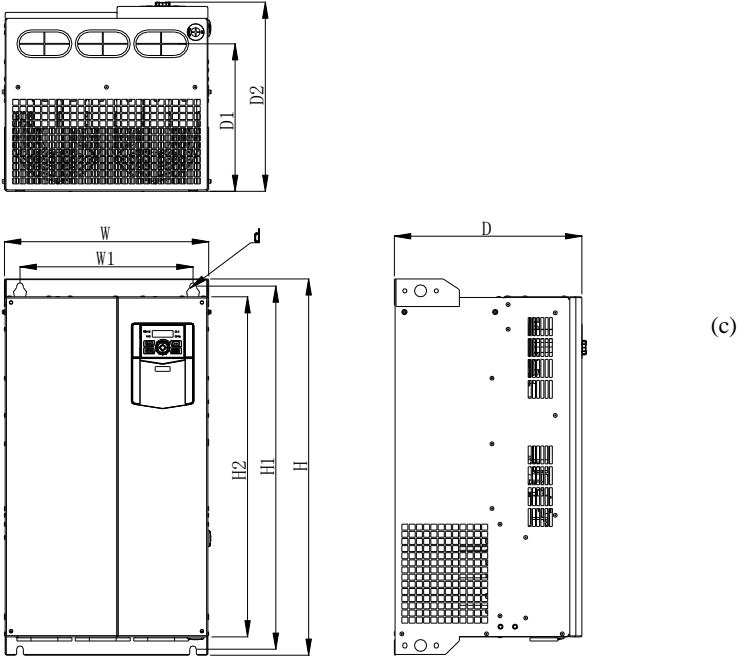

Appearance of EM730/EM730E-090-3 to EM730/EM730E-160-3 inverters

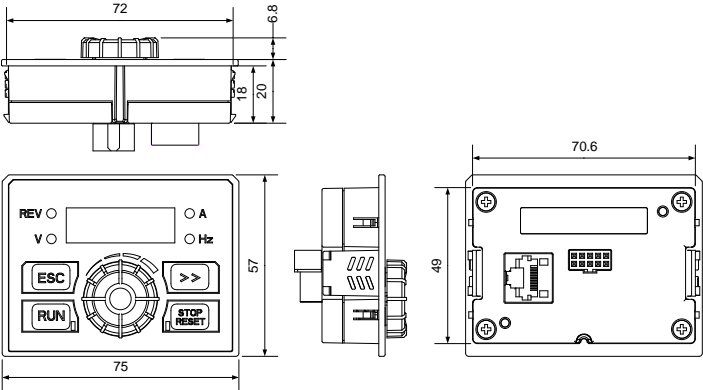

(d) EM730 keyboard appearance

Fig.2-1 Outline Dimensions of EM730/EM730E Series Inverter and Keyboard

Table 2-2 Outline and Installation Dimensions of EM730/EM730E Series Inverter

Specifications	W	W1	H	H1	H2	D	D1	D2	d
EM730/EM730E-0R4-2B	75	65	142	132		146	67	152	4.5
EM730/EM730E-0R7-2B									
EM730/EM730E-1R5-2B	93	82	172	163		136	85	141	4.7
EM730/EM730E-2R2-2B									
EM730/EM730E-0R7-3B	75	65	142	132		146	67	152	4.5
EM730/EM730E-1R5-3B									
EM730/EM730E-2R2-3B	93	82	172	163		136	85	141	4.7
EM730/EM730E-4R0-3B									
EM730/EM730E-5R5-3B	109	98	207	196		154	103	160	5.5
EM730/EM730E-7R5-3B									
EM730/EM730E-011-3B	136	125	250	240		169	115	174	5.5
EM730/EM730E-015-3B									
EM730/EM730E-018-3B	190	175	293	280		184	145	189	6.5
EM730/EM730E-022-3B									
EM730/EM730E-030-3	245	200	454	440	420	205	156	212	7.5
EM730/EM730E-030-3B									
EM730/EM730E-037-3									
EM730/EM730E-037-3B									
EM730/EM730E-045-3	300	266	524	508	480	229	174	236	9
EM730/EM730E-055-3									
EM730/EM730E-075-3	335	286	580	563	536	228	177	235	9
EM730/EM730E-090-3	335	286	630	608	570	310	247	317	11
EM730/EM730E-110-3									
EM730/EM730E-132-3	430	330	770	747	710	311	248	319	13
EM730/EM730E-160-3									

2.3 Installation Site Requirements and Management



Attention

- 1、 **When carrying the inverter, hold its bottom.**
If you hold the panel only, the body main fall to hit your feet.
- 2、 **Install the inverter on non-flammable boards (e.g. metal).**
If the inverter is installed on a flammable object, a fire may occur.
- 3、 **When two or more inverters are installed in one control cabinet, please install a cooling fan and keep the air temperature below 50 °C at the air inlet.**
Overheating may cause fire and other accidents.

2.3.1 Installation site

The installation site should meet the following conditions:

1. The room is well ventilated.
2. The ambient temperature should be -10°C to 50°C. When the plastic case is used at the ambient temperature above 40°C, remove the top baffle.
3. The controller should be free from high temperature and humidity (less than 90% RH) or rainwater and other liquid droplets.
4. Please install the inverter on a fire-retardant object (e.g. metal). Never install it on flammable objects (e.g. wood).
5. No direct sunlight.
6. There should be no flammable or corrosive gas and liquid.
7. There should be no dust, oily dust, floating fibers or metal particles.
8. The installation foundation should be secured and vibration-free.
9. Avoid electromagnetic interference and keep the controller away from interference sources.

2.3.2 Environment temperature

In order to improve the operational reliability, please install the inverter in a well-ventilated place. When it is used in a closed cabinet, a cooling fan or cooling air conditioner should be installed to keep the ambient temperature below 50°C.

2.3.3 Preventive measures

Take protective measures to the inverter during installation to prevent metal fragments or dust generated in drilling and other processes from falling into the inverter. Remove the protection after installation.

2.4 Installation Direction and Space

The EM730/EM730E-1R5-3B inverters and above are equipped with the cooling fan for forced air cooling. To ensure good cyclic cooling effects, the inverter must be installed in a vertical direction, and sufficient spaces must be reserved between the inverter and adjacent objects or baffles (walls). Refer to Fig. 2-2.

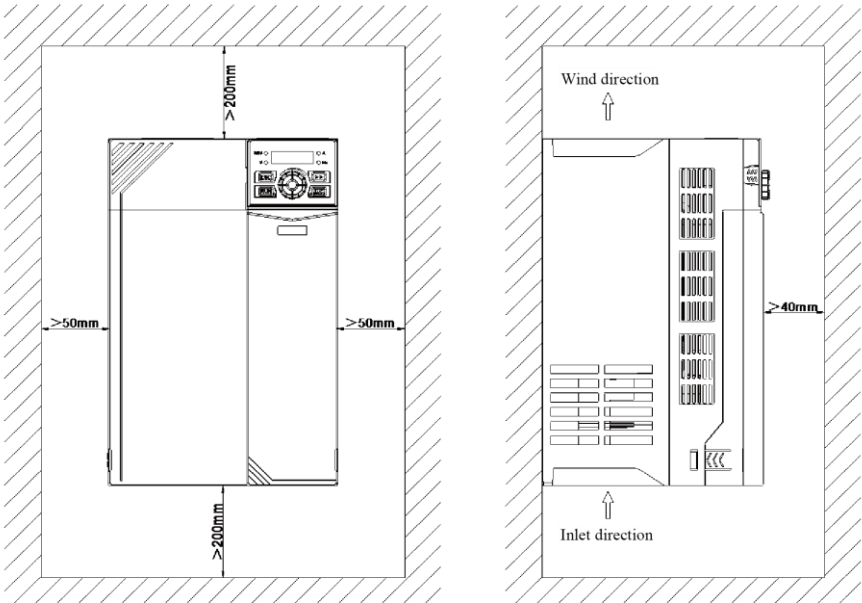

Fig.2-2 Inverter Installation Direction and Space

Chapter 3 Wiring

3.1 Connection of Peripheral Device

The standard connection between the EM730/EM730E series inverter and peripheral devices is shown in Fig.3-1.

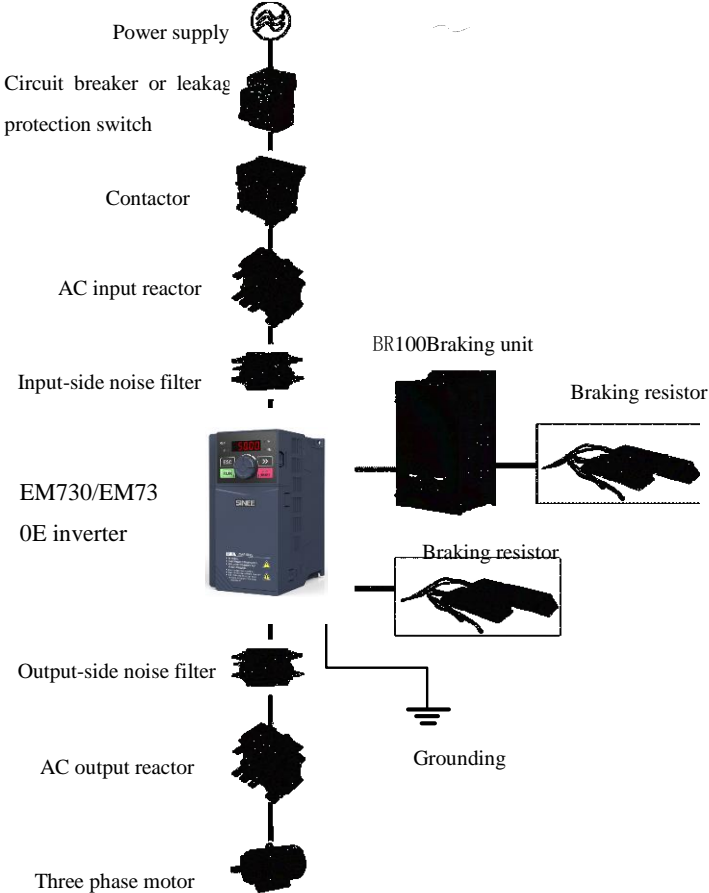

Fig.3-1 Connection of Inverter and Peripheral Devices

3.2 Wiring of Main Circuit Terminal

3.2.1 Composition of main circuit terminal

The main circuit terminal of the EM730/EM730E series inverter consists of the following parts:

- Three-phase AC power input terminals: R, S, T
- Earth terminal: \perp
- DC bus terminals: \oplus \ominus
- Terminals of dynamic braking resistor: PB, \oplus
- Motor terminals: U, V, W

The layout of main circuit terminals is shown in Fig. 3-2.

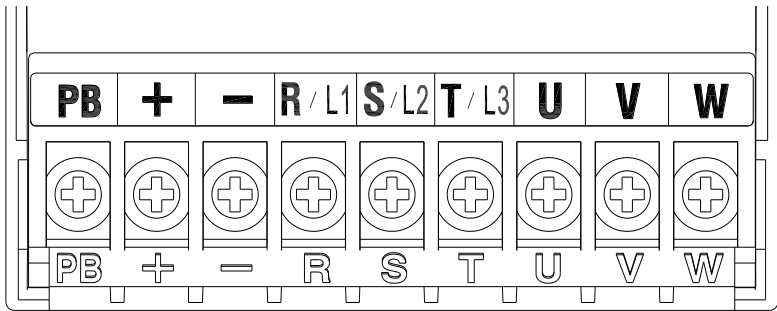

a) Schematic Diagram of Terminals (380V, 0.75kW-1.5kW)

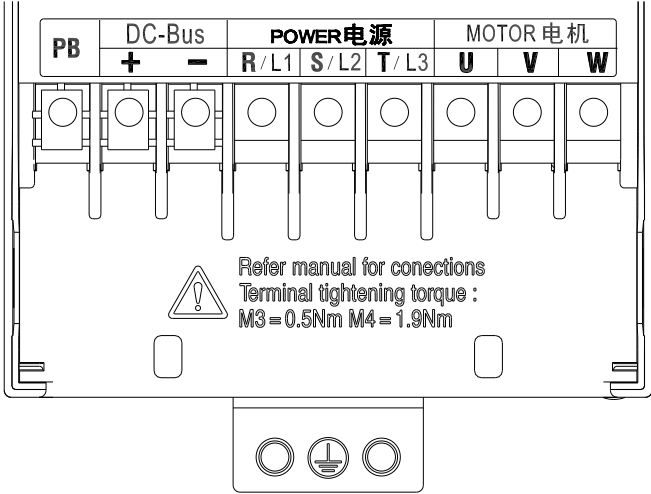

b) Schematic Diagram of Terminals (380V, 2.2kW-4.0kW)

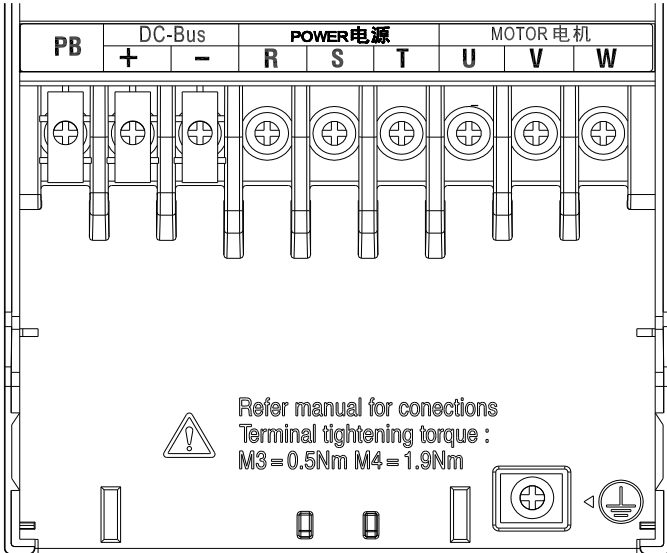

c) Schematic Diagram of Terminals (380V, 5.5kW-22kW) (with slight difference in the grounding position)

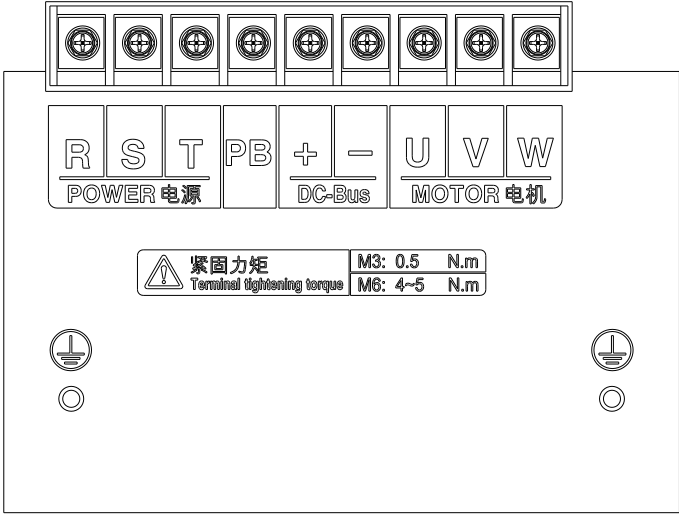

d) Schematic Diagram of Terminals (380V, 30kW-37kW)

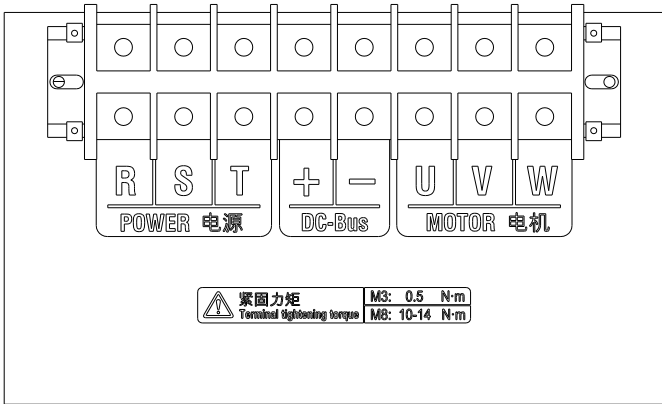

e) Schematic Diagram of Terminals (380V, 45kW-110kW)

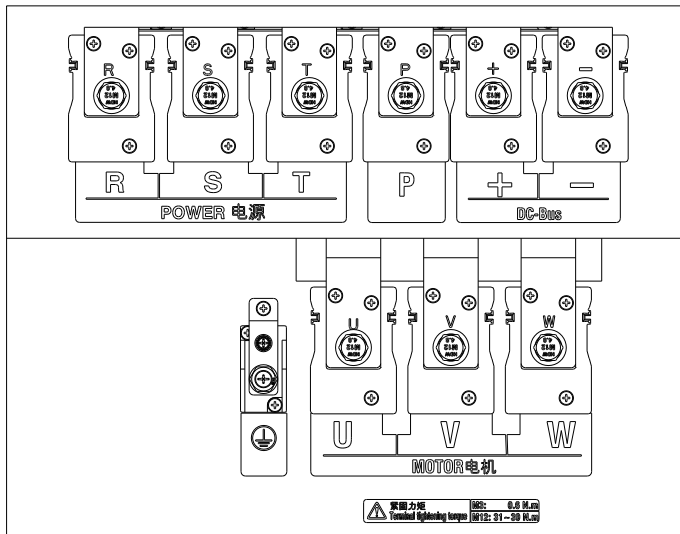

f) Schematic Diagram of Terminals (380V, 132kW-160kW)

Fig.3-2 Schematic Diagram of Main Circuit Terminal Layout

3.2.2 Functions of main circuit terminals

The functions of the main circuit terminals of the EM730/EM730E series inverter are shown in the following table. Please connect wires correctly according to the corresponding functions.

Functions of main circuit terminals

Terminal label	Function description
R/L1, S/L2, T/L3	AC power input terminal, connected to three-phase AC power supply (the single-phase power input terminal can be connected with any two terminals)
U, V, W	AC output terminal of the inverter, connected to three-phase AC motor
\oplus \ominus	Positive and negative terminals of the internal DC bus, connected to external braking unit
\oplus , PB	Braking resistor terminal, with one end of the braking resistor connected to \oplus and the other end to PB
P, \oplus	DC reactor terminal, for the external DC reactor of EM730/EM730E-090-3 and above
\ominus	Grounding terminal, connected to earth

3.2.3 Standard wiring diagram of main circuit

The standard wiring diagram of the main circuit of the EM730/EM730E series inverter is shown in Fig. 3-3.

● Wiring of built-in brake unit

● Wiring of external brake unit

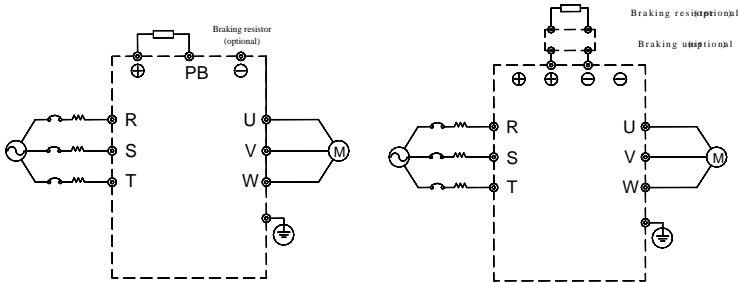

Fig.3-3 Standard Wiring of Main Circuit

3.2.4 Input side wiring of main circuit

Installation of circuit breaker

Install the air circuit breaker (MCCB) corresponding to the inverter between the power supply and input terminal.

- The MCCB capacity should be 1.5-2 times the rated current of the inverter.
- The time characteristics of the MCCB must meet the requirements for overheat protection (150% rated current/1 minute) of the inverter.
- When the MCCB is used with multiple inverters or other devices, connect the protection output relay contact of the inverter in series to the power contactor coil, as shown in Fig.3-4, to disconnect the power supply according to the protection signal.

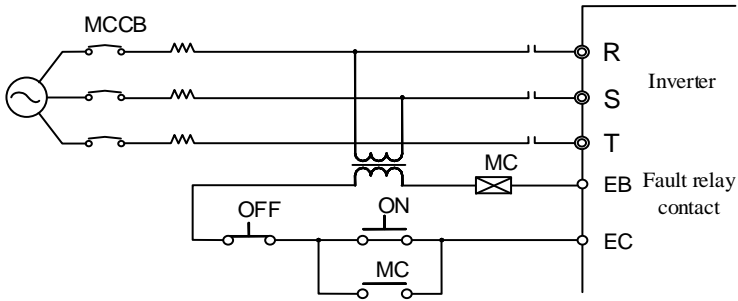

Fig.3-4 Connection of Input Circuit Breaker

Installation of leakage circuit breaker

Since the inverter outputs high-frequency PWM signals, a high-frequency leakage current will be generated. Please use the dedicated leakage circuit breaker with the current sensitivity above 30 mA. If an ordinary leakage circuit breaker is used, use a leakage circuit breaker with the current sensitivity above 200 mA and action time of more than 0.1 s.

Installation of electromagnetic contactor

Connect the electromagnetic contactor that matches the power of the inverter, as shown in Fig. 3-4.

- Do not control the operation and stop of the inverter via the electromagnetic contactor on the incoming line side. Frequent use of this method is an important cause of damage to the inverter. The frequency of operation and stop of the electromagnetic contactor on the incoming line side must not exceed once every 30 min.
- After the power supply is restored, the inverter will not run automatically.

Connection with terminal block

The phase sequence of the input power supply is unrelated to that (R, S, T) of the terminal block, so that the terminals of the input power supply can be connected arbitrarily.

Installation of AC reactor

When a large-capacity (above 600KVA) power transformer is connected, or the input power supply is connected to a capacitive load, a high inrush current will be generated, which

will cause damage to the rectifier part of the inverter. In this case, please connect a three-phase AC reactor (optional) to the input side of the inverter. This will not only suppress the peak current and voltage, but also improve the power factor of the system.

Installation of surge suppressor

When an inductive load (electromagnetic contactor, solenoid valve, solenoid coil, electromagnetic circuit breaker, etc.) is connected near the inverter, please install a surge suppressor.

Installation of noise filter on power supply side

The noise filter is used to suppress the noise that invades the inverter from the power cable, and the impact of inverter noise on the power grid.

- Use a dedicated noise filter for the inverter. Ordinary noise filters do not have good effects, so they are not used usually.
- The correct and incorrect installations of the noise filter are shown in Fig. 3-5 and Fig. 3-6.

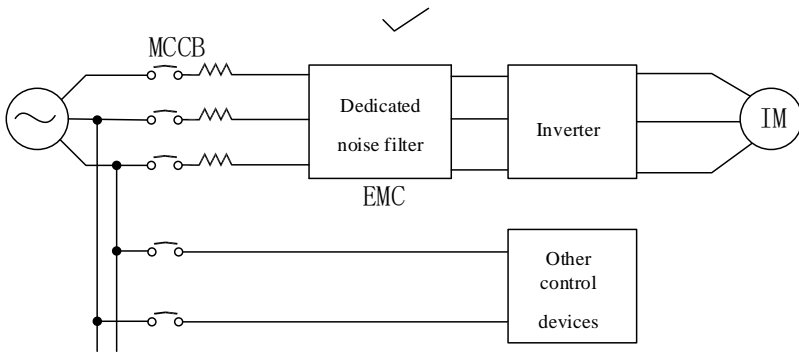

Fig.3-5 Correct Installation of Noise Filter

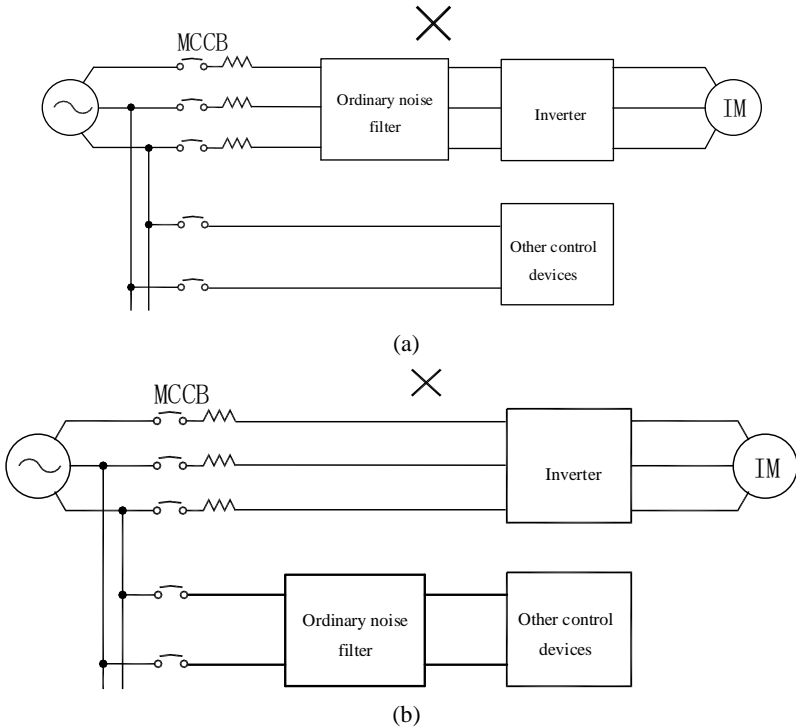

Fig. 3-6 Incorrect Installation of Noise Filter

3.2.5 Output side wiring of main circuit

Wiring of inverter and motor

Connect the output terminals (U, V, W) of the inverter to those (U, V, W) of the motor.

During operation, check whether the motor rotates forward when a forward rotation command is sent. If the motor rotates reversely, exchange any two wires of the output terminals (U, V, W) of the inverter.

Prohibition of connection of the power cable to output terminal

Never connect the power cable to output terminal. When the voltage is applied on the output terminal, the internal components of the inverter may be damaged.

Prohibition of short circuit or grounding of output terminal

Do not directly touch the output terminals, or short-circuit the output cable and inverter housing; otherwise, electric shock and short circuit may be caused. In addition, never short-circuit the output cable.

Prohibition of use of phase-shifting capacitor

Do not connect a phase-shifting advanced electrolytic capacitor or LC/RC filter to the output circuit; otherwise, the inverter may be damaged.

Prohibition of use of electromagnetic switch

Do not connect the electromagnetic switch or electromagnetic contactor to output circuit. Otherwise, such devices will enable overcurrent and overvoltage protection and even damage the internal components of the inverter in severe cases.

When an electromagnetic contactor is used to switch the PF power supply, make sure that switching is not performed until the inverter and motor are shut down.

Installation of noise filter on output side

Connect a noise filter on the output side of the inverter to reduce inductive interference and radio interference.

- Inductive interference: Electromagnetic induction will lead to noise of the signal line and malfunction of controls.
- Radio interference: The high-frequency electromagnetic waves emitted by the inverter itself and cables will cause interference to nearby radio devices and noise in signal reception.
- The noise filter installation on the output side is shown in Fig. 3-7.

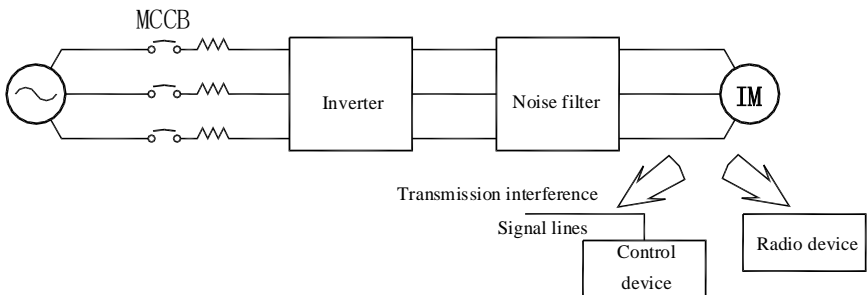

Fig.3-7 Noise Filter Installation on Output Side

Solution to inductive interference

To suppress the inductive interference on the output side, all output cables can be laid in the grounded metal tubes, in addition to the aforesaid installation of the noise filter. When the distance between the output cable and signal line is greater than 30 cm, the impact of inductive interference will decrease significantly, as shown in Fig. 3-8.

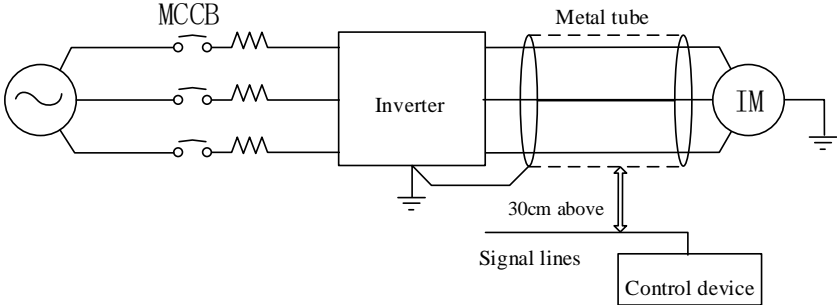

Fig.3-8 Solution to Inductive Interference

Solution to RF interference

The input cable, output cable and inverter itself generates RF interference, which can be reduced by installing noise filters on the input and output sides and shielding the inverter body with an iron box, as shown in Fig. 3-9.

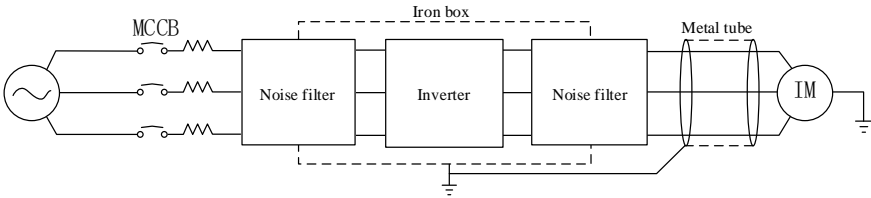

Fig.3-9 Solution to RF Interference

Wiring distance between inverter and motor

The longer the wiring distance between the inverter and motor, the higher the carrier frequency and the higher harmonic leakage current in the cable. This will adversely affect the inverter and nearby devices. Refer to Table 3-2 to adjust the carrier frequency and reduce the high-frequency leakage current.

- When the motor wiring distance exceeds 50 m, connect the output terminals (U, V, W) of the inverter with the dedicated AC reactor (phase capacity: the same as that of the inverter) for inverter output.

Table3-2 Wiring Distance and Carrier Frequency between Inverter and Motor

Wiring distance between inverter and motor	<50m	<100m	>100m
Carrier frequency	Below 10kHz	Below 8kHz	Below 5kHz
Function code F00.23	10.0	8.0	5.0

3.2.6 Cable and screw dimensions of main circuit

The cable and screw dimensions of the main circuit are shown in Table 3-3.

Table3-3 Cable Dimensions and Terminal Screw Specifications

Frequency converter model	Terminal Symbol	Terminal Screw	Tightening Torque (N.m)	Wire diameter (mm ³)	Wire Type
EM730/EM730E-0R4-2B	PB, +, -, R, S, T, U, V, W	M3	0.5~0.7	1.5	750V wire
EM730/EM730E-0R7-2B					
EM730/EM730E-0R7-3B					
EM730/EM730E-1R5-3B					
EM730/EM730E-1R5-2B					
EM730/EM730E-2R2-2B		M4	1.5~2.0	4	
EM730/EM730E-2R2-3B					
EM730/EM730E-4R0-3B					
EM730/EM730E-5R5-3B					
EM730/EM730E-7R5-3B					
EM730/EM730E-011-3B		M5	3.0~4.0	10	
EM730/EM730E-015-3B					
EM730/EM730E-018-3B					
EM730/EM730E-022-3B					
EM730/EM730E-030-3B	R, S, T, PB, +, -, U, V, W,			M6	4.0~5.0
EM730/EM730E-037-3B					
EM730/EM730E-030-3					
EM730/EM730E-037-3					
EM730/EM730E-045-3	R, S, T, +, -, U, V, W,	M8	9.0~10.0	35	
EM730/EM730E-055-3				35	
EM730/EM730E-075-3				60	

EM730/EM730E-090-3	R, S, T, P, +, -, U, V, W	M10	17.0~22.0	60	
EM730/EM730E-110-3				90	
EM730/EM730E-132-3				90	
EM730/EM730E-160-3				120	

Table 3-1 Cable Dimensions and Terminal Screw Specifications **Note:** 1: The specifications of the wire are dependent on its voltage drop. Under normal circumstances, the voltage drop calculated by the following formula should be less than 5V.

$$\text{Voltage drop} = \sqrt{3} * \text{wire resistivity } (\Omega/\text{KM}) * \text{wire length (m)} * \text{rated current (A)} * 10^{-3}$$

2: If the wire is in a plastic slot, it should be enlarged by one level.

3: The wire should be crimped to the round terminal suitable for the wire and terminal screw.

4: The specification of the ground wire should be the same as that of the power cable smaller than 16mm². When the power cable is 16mm² or larger, the ground wire should not be smaller than 1/2 of the power cable.

3.2.7 Ground wire

- The ground terminal  must be grounded.
- Pay special attention to the third type of grounding (grounding resistance: less than 10Ω).
- The ground wire must not be shared by the welding machine and power devices.
- Select the ground wire according to the technical specifications for electrical equipment, and minimize the length of the ground wire connected to the grounding point.
- Where two or more inverters are used, the ground wires must not form a loop. The correct and incorrect grounding methods are shown in Table 3-10.

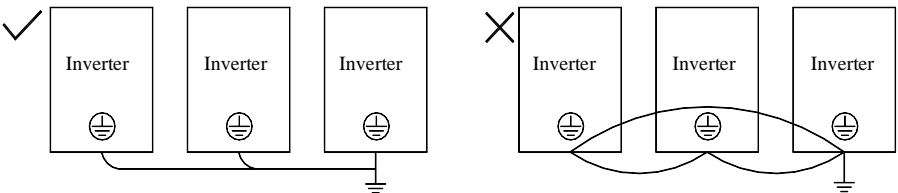

Fig.3-10 Connection of Ground Wire

3.2.8 Installation and wiring of braking resistor and braking unit

Refer to Chapter 10 for the selection and wiring of the braking resistor and braking unit.

For the inverter with a built-in braking unit, connect the braking resistor between the inverter terminal (+) and PB terminal. For the inverter with no built-in braking unit, connect the terminals (+ and -) of the braking unit to those (+ and -) of the DC bus of the inverter, and the braking resistor to the PB+ and PB- terminals of the braking unit. Refer to the user manual of the BR100 braking unit for more information.

3.3 Wiring of Control Circuit Terminal

3.3.1 Composition of control circuit terminal

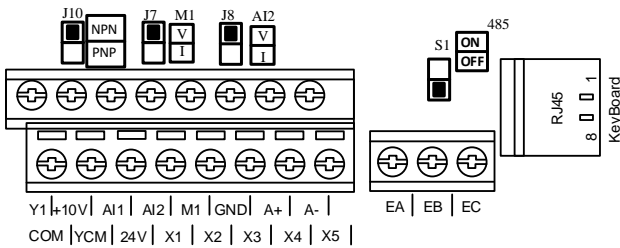

Fig.3-11 Layout of Control Circuit Terminals 1

3.3.2 Functions and wiring of control circuit terminals

Table 3-3 Functions of Control Circuit Terminals

Category	Terminal label	Terminal name	Function description
Power supply	24V	External power supply	Supply 24V power to external devices, with the maximum output current of 100mA.
	COM	Power grounding terminal	Power grounding terminal of the external power supply, and common side of the digital input terminal
Analog input	10V	Analog terminal power supply	Supply 10V power to external devices. Maximum output current: 10.5±0.5V/20mA, usually as the power supply of the external potentiometer
	GND	Analog power	Grounding terminal of analog input and

		grounding terminal	output
	AI1	Analog voltage input	-10V to 10V, 50kΩ input impedance, bipolar analog voltage input
	AI2	Analog current/voltage input	Current or voltage type Input range: 0/4-20mA or 0-10V
Analog output	M1	Analog voltage/current output	0-10V/0-20mA; output accuracy: ±2%
Digital input port	X1	Multi-function input terminal	<p>Program the corresponding terminals by setting function codes, to realize the input control of the set functions.</p> <p>The input terminal supports PNP and NPN input modes, and the default mode is the NPN input mode.</p> <p>X5 can also be used as the high-frequency pulse input, with the input frequency up to 100kHz.</p>
	X2		
	X3		
	X4		
	X5		
Multi-function digital output	Y1	Open collector output terminal	It can be programmed as the multi-function output terminal.
	YCM	Common side of Y terminal	The common side YCM of Y terminal and the common side COM of the digital input terminal are independent of each other.
Communication	A+	RS485 communication terminal	positive terminal of RS485 differential signal
	A-		negative terminal of RS485 differential signal
Relay output	EA	Relay output terminal	EA-EC: Normally open EB-EC: Normally closed
	EB		
	EC		
External	RJ45	External keyboard	For the external operation panel

keyboard port		terminal	The upper computer can also be connected through this port for background software debugging.
---------------	--	----------	---

3.3.3 Wiring of analog input terminal

Wiring of AI1 and AI2 terminals with analog voltage signal:

When the AI2 terminal is in the mode of analog voltage signal input, the switch J8 on the control panel is set to the voltage mode, as shown in Fig. 3-12

When the analog voltage input signal is powered by an external power supply, the wiring of terminals AI1 and AI2 is shown in Fig. 3-12-a.

When the analog voltage input signal is sent by a potentiometer, the terminals AI1 and AI2 are connected as shown in Fig. 3-12-b.

In addition, F02.62 (AI1 input type) and F02.63 (AI2 input type) should be set according to actual needs (0: 0-10V; 1: 4-20mA; 2: 0-20mA; 4: 0-5V).

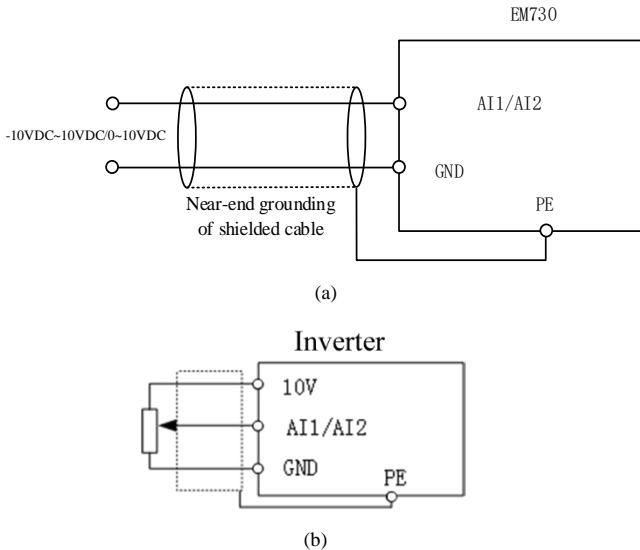

Fig.3-12 AI1/AI2 Terminal Wiring Diagram

Wiring of the input analog current signal of AI2 terminal:

When the AI2 terminal is in the mode of analog current signal input, the switch J8 on the

terminal block is set to the current mode.

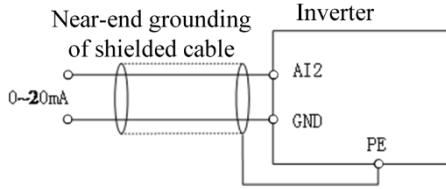
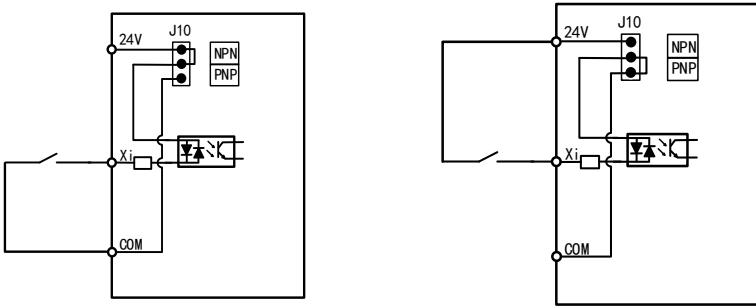

Fig.3-13 Wiring Diagram of External Current Source and AI2 Terminal

3.3.4 Wiring of multi-function input terminal

The multi-function input terminals of EM730/EM730E series inverters support the access in the NPN or PNP mode. The terminals X1-X5 can be flexibly connected with external devices. The NPN or PNP mode (NPN by default) can be selected via the jumper cap J10 on the control panel. The wiring of the multi-function input terminal in different modes is shown below:



a: Use of internal power supply in NPN mode

b: Use of internal power supply in PNP mode

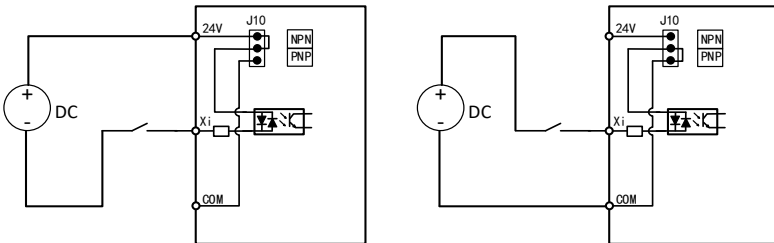

c: Use of external power supply in NPN mode

d: Use of external power supply in PNP mode

Fig. 3-14 Wiring Diagram of Multi-function Input Terminals

3.3.5 Wiring of multi-function output terminals

The multi-function output terminal Y1 is powered on by the internal 24V power supply of the inverter or an external power supply, as shown in Fig. 3-15:

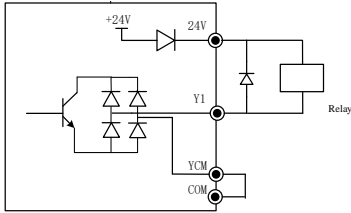

a: Use of internal power supply NPN

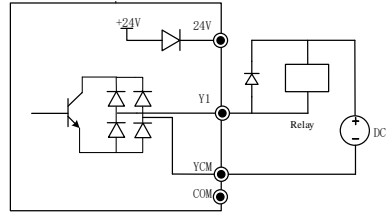

b: Use of external power supply NPN

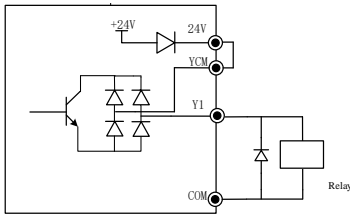

a: Use of internal power supply PNP

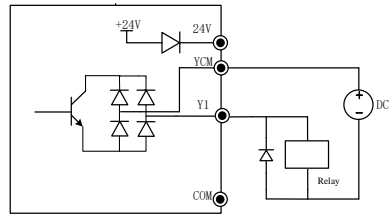

b: Use of external power supply PNP

Fig.3-15 Wiring of Multi-function Output Terminals

Note: (1) An anti-parallel diode must be included in the relay wire package. The absorption circuit components should be installed at both ends of the coil of the relay or contactor.

3.3.6 Wiring of analog output terminals

The external analog meter connected to the analog output terminal M1 indicates a variety of physical quantities. Choose the output current (0-20mA) or (0-10V) via the jumper cap, M1 corresponding to J7. Set F03.34 as needed (0: 0-10V; 1: 4-20mA; 2: 0-20mA). The jumper cap and terminal wiring is as follows:

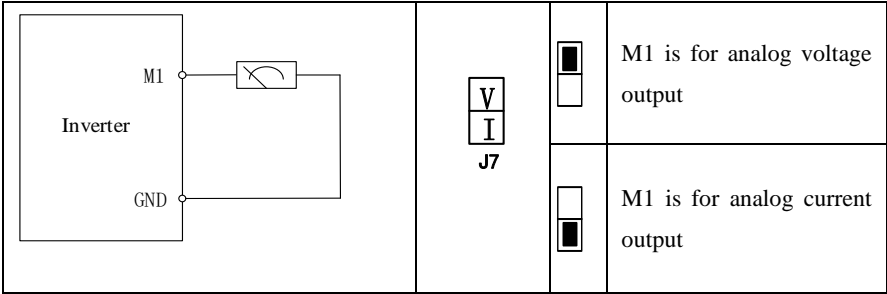

3.3.7 Wiring of 485 communication terminals

The communication terminals A+ and A- are the RS485 communication interfaces of the inverter. The online control of the host (PC or PLC controller) and inverter is performed through the connection and communication with the host. The connection of the RS485 and RS485/RS232 adapters to EM730/EM730E series inverter is shown in Fig. 3-16, Fig. 3-17 and Fig. 3-18.

- Direct connection of the RS485 terminal of a single inverter to the host for communication:

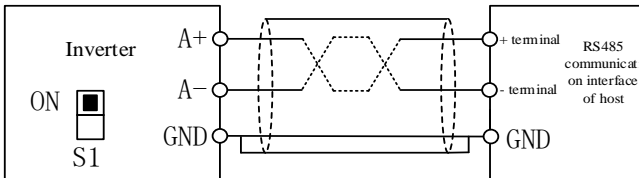

Fig.3-16 Communication Terminal Wiring of Single Inverter

- Connection of the RS485 terminals of multiple inverters to host for communication:

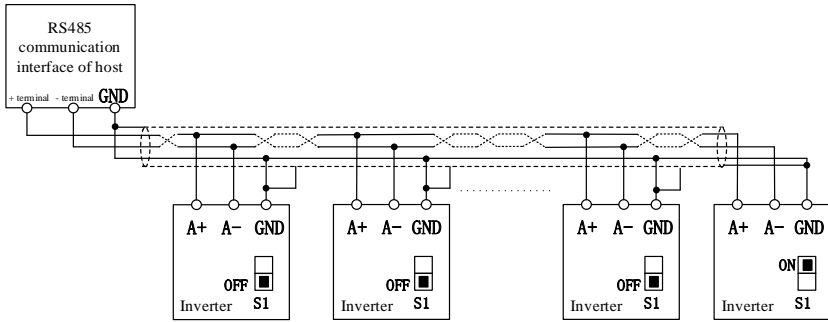

Fig. 3-17 Wiring of Communication Terminals of Multiple Inverters

- Connection to the host via RS485/RS232 adapter for communication:

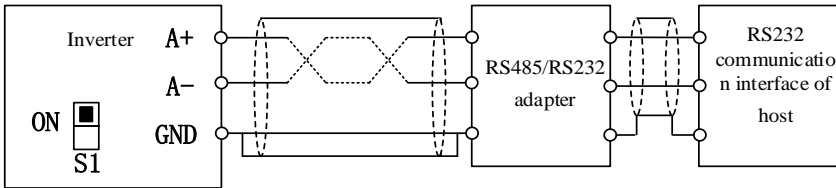

Fig. 3-18 Communication Terminal Wiring

3.3.8 Wire and screw dimensions of control circuit

- In order to reduce the interference and attenuation of the control signal, the control signal connection cable should be less than 50 m long, and the distance between the control signal connection cable and power line should be greater than 30 cm. Use the twisted-pair shielded cable when analog signals are externally inputted.
- It is recommended to use the wire with a diameter of 0.5-1 mm² in the control circuit.
- The terminal block of the EM730/EM730E series inverter is composed of through-type control circuit terminals. Install it with the PH0 Phillips screwdriver. The tightening torque should be 0.5N.m.

3.3.9 Precautions for control circuit wiring

- Connect the control circuit connection wires and other wires separately.
- Connect the control circuit terminals EA, EB, EC, and Y1 separately from other control circuit terminals.
- In order to avoid malfunction caused by interference, use the twisted shielded cables

in the control circuit. The wiring distance should be less than 50 m.

- Prevent the shield screen from contact with other signal lines and enclosures. The exposed shield screen can be wrapped with insulating tapes.
- It is prohibited to touch the ports and components of the control panel without static electricity protection measures.

3.3.10 Standard Wiring Diagram of Control Circuit

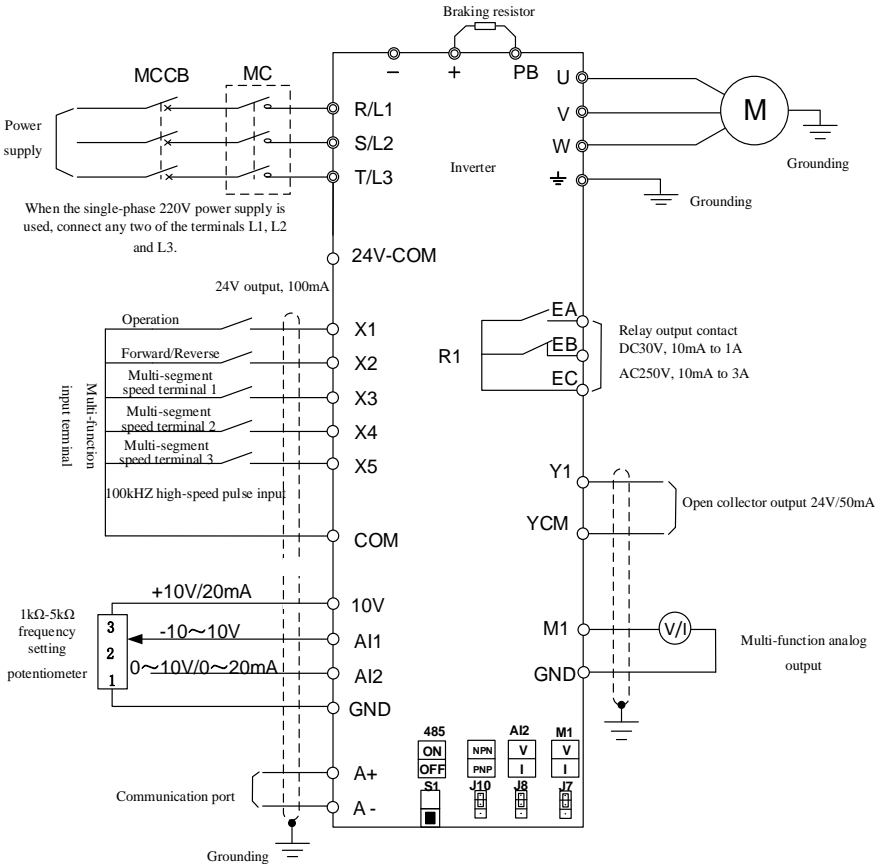

Fig. 3-19 Standard Wiring Diagram of Control Circuit

- It is recommended to use the wires with a diameter of 0.5-1mm² in the control circuit.
- Install the control circuit terminals with the PH0 Phillips screwdriver. The tightening torque

should be 0.5N.m.

3.4 Extension wiring of keyboard

- 1) The external keyboard needs to be ordered separately.
- 2) The external keyboard is connected to the RJ45 port via an ordinary network cable (plug: meeting the EIA/TIA568B standards) prepared by the customer.
- 3) Connect the RJ45 port of the keyboard to that of the control panel via a network cable. The keyboard extension cable should be no longer than 3m. Then extension cable may be 10m long in the presence of Cat5E wires and good electromagnetic environments.

3.5 Connection test

After wiring, check the following items.

- Check whether wiring is incorrect.
- Check whether there are screws, terminals and wire scraps inside the inverter.
- Check whether the screws are loose.
- Check whether the exposed wire at the stripped end of the terminal is in contact with other terminals.

Chapter 4 KEYBOARD OPERATIONS

4.1 Keyboard Functions

4.1.1 Structure of LED keyboard

The control panel of EM730/EM730E series inverter is a pluggable LED keyboard. The LED keyboard has one five-digit LED digital display, four operation buttons, one digital potentiometer, and six status and unit indicators. Users can perform parameter setting, status monitoring and start/stop of the inverter via the keyboard.











Fig. 4-1 LED Keyboard



4.1.2 Functions of keys and indicators on LED keyboard

The functions of the keys and indicators on the LED keyboard are as shown in Table 4-1.

Table 4-1 Functions of Keys and Indicators on LED Keyboard

Key/Indicator	Name	Function
	Right	Select the group number and function number of the currently modified function code. Change the monitoring parameters.
	Back	Go back to the previous menu. Cancel the current parameter modification when the menu mode selection level is enabled from the monitoring level.
	Run	When the keyboard control is enabled, press this key to start the inverter.
	Stop/Reset	When the keyboard control is enabled, press this key to stop the inverter. Reset the protection in use.
	Potentiometer/Confirm key	Turn it clockwise to select the function code and menu group or increase the parameter value. Increase the currently valid reference digital input data.

		Turn it counterclockwise to select the function code and menu group or decrease the parameter value. Decrease the currently valid reference digital input data.
		Click it to enter the lower-level menu. Confirm and save the parameter modification, and enable the function code following the current function code.
	Unit indicator	It is ON when the frequency, current, and voltage are displayed.
	Running direction indicator	This indicator is ON during reverse running. It is OFF during forward running. It is ON when a certain frequency is being monitored or displayed.
 (Green)	Running indicator	It is ON when the inverter is running, flickering when the inverter is being stopped, and OFF after the inverter is stopped.
 (Red)	Protection indicator	When the inverter is in the protection status, this indicator will be ON in red.



( and  below means that the potentiometer rotates clockwise and counterclockwise.)

4.2 Operation Mode of Keyboard with Digital Tube Display

The LED keyboard menu is divided into the monitoring level (Level 0), menu mode selection level (Level 1), function code selection level (Level 2) and parameter level (Level 3) from low to high. The menu levels mentioned below are represent by numbers.

There are five parameter display modes: menu mode ($--\#--$), used to display all function codes; user-defined mode ($--U--$), used to display only function codes selected by the user based on the F11 group; non-default mode ($--\text{L}--$), used to display only the function codes that differ from the default settings;

Protection information display mode ($--\text{E}--$): display the current protection information; version information mode ($--P--$): display software and product serial numbers.

When the keyboard is powered on, the first monitoring parameter of Level 0 is displayed by default. Press the ESC key  to open the Level 1 menu. Users can turn the potentiometer indicator  in the keyboard to select different menu modes. The process of menu mode selection is shown in Fig. 4-2.

In the Level 3 menu, press the ESC key  to abandon parameter modifications.

4.2.2 User-defined mode (—U—)

Enter the F11 group of function codes from the full menu mode. Then the user can arbitrarily set the shortcut for the parameter to be accessed frequently. When F11.00 is enabled for the first time, U00.00 will be displayed by default, meaning that the function code defined by default for F11.00 is F00.00. The lowest cursor bit will flicker. The user can set any function code, similar to the function code selection in the Level 2 menu. After setting, press the ENTER key  to save it and enter the user-defined menu mode to display the set function code.

For example, F11.00 is set to U00.07 and F11.01 to U00.09. F11.00 and F11.01 will be defined as F00.07 and F00.09, respectively. They are distinguished by U and F. U indicates that this function code is user-defined, as shown in Fig. 4-4.

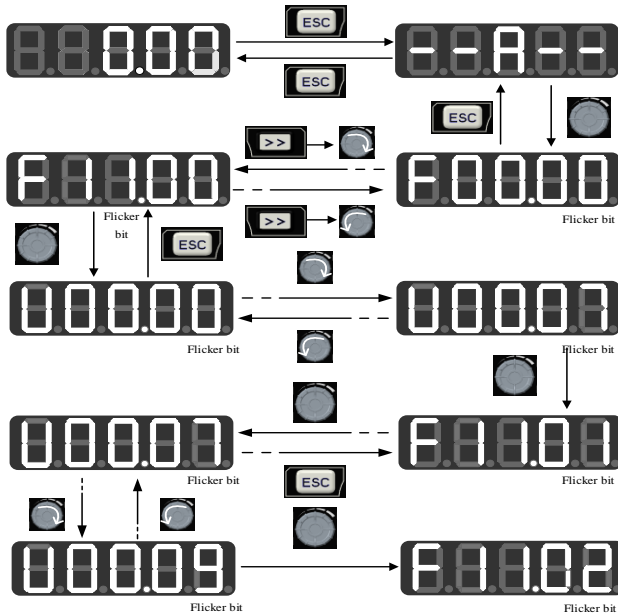





Fig. 4-4 Example of User-defined Mode Setting

In the user-defined mode, press the ENTER key  to enter the Level 2 menu. The Level 2 menu only display 32 user-defined parameters in the F11 group. The user can enter the F11 group from the full menu mode to set these function codes.



After the function codes are defined in the F11 group, enter the user-defined mode. Then we can see F00.07 defined by the first function code F11.00, F00.09 defined by the first function



code F11.01, and so on to F11.31, 32 in total. Function code modification in the Level 3 menu is equivalent to that in the full menu mode, and the modification method is also the same.

In the Level 2 menu of the user-defined mode, turn the potentiometer key  on the keyboard, to change the function code defined by F11.00 to that defined by F11.31.

When the right shift key  is pressed in the Level 2 menu, the cursor will not shift. Press the ENTER key  to enter the Level 3 menu. If the displayed function code is modifiable currently, the lowest bit indicated by the cursor will flicker. Parameter modification is the same as that in the Level 3 menu under the full menu mode. After modification, press the ENTER key ENTER to confirm and save the parameters and enable next user-defined parameter. Function code modifications in the Level 3 menus under different menu modes have equivalent effects.

4.2.3 Non-default mode (—└—)

In the non-default mode, press the ENTER key to enter the Level 2 menu. The first parameter different from the default settings of the inverter will be displayed, starting from F00.00. When the right shift key  is pressed in the Level 2 menu, the cursor will not shift. If the increment or decrement key on the keyboard is pressed, the function group and function code will not be modified, and the non-default function code following and in front of the current function code will be displayed respectively. If the displayed function code is modifiable currently in the Level 3 menu, the lowest bit indicated by the cursor will flicker. In this case, parameters can be modified in the Level 3 menu under the full menu mode. After modification, press the ENTER key  to confirm and save the parameters and enable next non-default parameter.

For example, change F00.03 to 1 and F00.07 to 40.00 in the full menu mode, which are not default values. Then enable the non-default mode. F00.03 will be displayed first. When the potentiometer key  on the keyboard is turned clockwise, F00.07 will be displayed; and when the potentiometer key  on the keyboard is turned counterclockwise, F00.03 will be returned, as shown below:

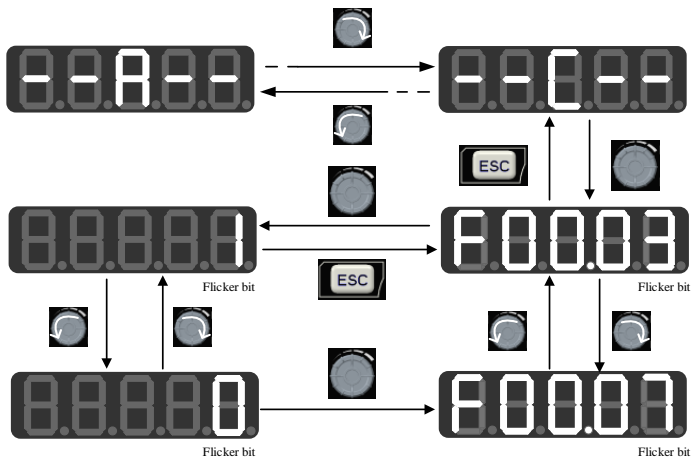





Fig. 4-5 Function Code Modification in Non-default Mode

4.2.4 Protection information display mode (—E—)

In the protection information display mode, press the ENTER key to enter the Level 2 menu. The Level 2 menu will only display the fault record group under the F19 group, which is conducive to direct viewing of protection record information.

Turn the potentiometer key  on the keyboard in the Level 2 menu under this mode to increase or decrease the function code of the protection group, and the shift key  will be unavailable. In case of protection, you can press the shift key  on the keyboard in the Level 3 menu to switch the display of the protection code, protection output frequency, protection output current, protection bus voltage, and protection operation status.

4.3 Protection Monitoring

When the inverter is in the protection status, you can directly press the right shift key  to switch the current protection type and the output frequency, output current, output voltage, running status and working time during the protection.

4.4 Operation Monitoring

4.4.1 Normal monitoring







In the monitoring status mode 1 of EM730/EM730E, you can set any function code to be viewed between F12.33 and F12.37. When F12.32=1, the monitoring mode 1 will be enabled. If the Level 0 monitoring menu appears, you can press the right shift key  to switch the monitoring parameters according to the order set for each function code between F12.33 and F12.37. When the inverter changes from the stop status to running status, the monitoring

parameter will automatically change from the current value to that indicated by F12.33. When the inverter changes from the running status to stop status, the monitoring parameter will automatically change from the current value to that indicated by F12.34.

4.4.2 Editing Mode

Quick change in the monitoring mode:

When F00.04 is set to “0: digital frequency setting F00.07”, turn the potentiometer key  to directly change the offset;

When F00.04 is set to “8: digital potentiometer”, turn the potentiometer key  to change the set frequency of F12.42 digital potentiometer. In this case, turn the potentiometer key  to enter the editing mode. The value will change from the second digit of the digital tube by default. The digital tube corresponding to the changed digit will flash. Press the right shift key  to move to next digit on the right. Press the ESC key  to cancel change and return to the original value. Or, press the ENTER key  to confirm the change and exit the editing mode. The indicator will not be flicker. Press the right shift key  to enable the normal monitoring mode: switch to next monitoring parameter. Fig. 4-6 shows the editing status in the monitoring mode.

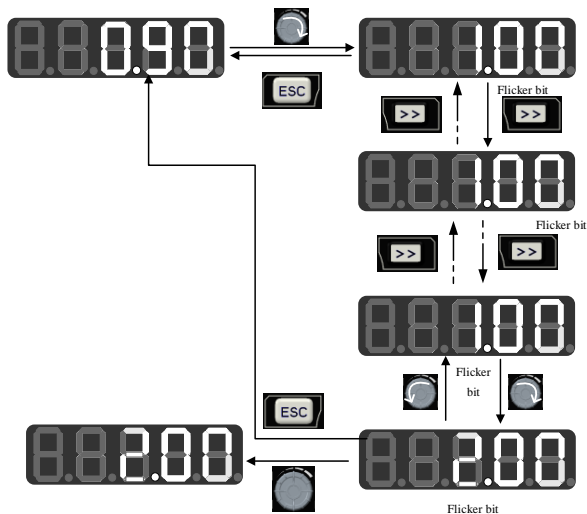



Fig. 4-6 Editing Status in the Monitoring Mode

4.5 Run/Stop

After setting the parameters, press the RUN key  to enable the normal operation of

the inverter, and the STOP/RESET key  to stop the inverter.

4.6 Other Warning Prompts

4.6.1 P.-ON prompt

The P.-ON prompt will be displayed after power-on initialization.

4.6.2 P.-OFF prompt

When the voltage drops to 250V (with the soft start disconnected), P-OFF will be displayed, and the keyboard can be operated freely to exit the P.-OFF display and display normal information. In case of no keyboard operation within 5s, P-OFF will be displayed again. After the voltage is restored and the soft start is engaged, P.-ON will be displayed again.

4.6.3 SOFT.E warning

If the soft start is not engaged and the inverter is started, the SOFT.E warning will appear. After the voltage is restore and the soft start is engaged, normal operation will be enabled.

Chapter 5 Trial run

5.1 Inverter Commissioning Process

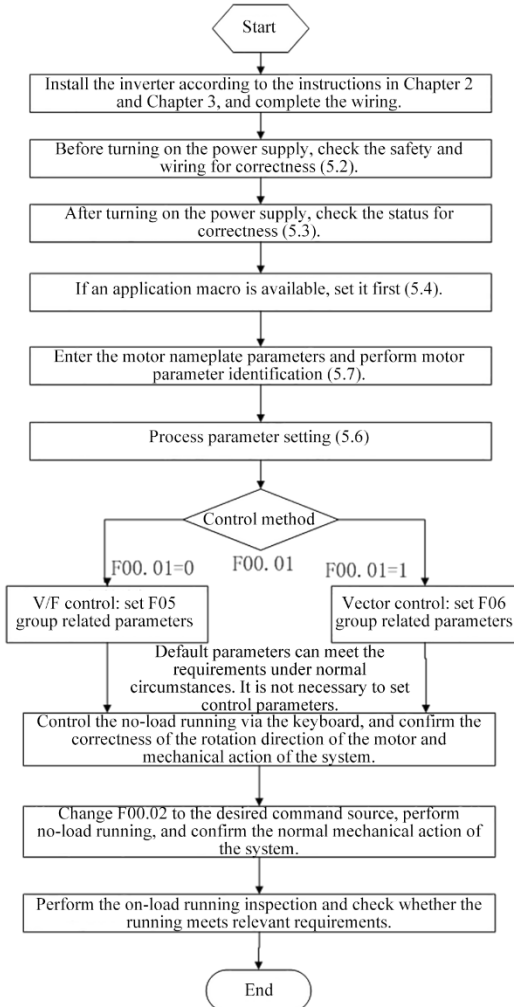

Fig. 5-1 Inverter Commissioning Flowchart

5.2 Confirmation before Power-on

Please confirm the following items before turning on the power supply:

Item to be confirmed	Confirmation content
Power wiring confirmation	Check whether the input power voltage is consistent with the voltage of the inverter.
	Confirm that the circuit breaker has been connected to the power supply circuit, and the power cables are correctly connected to the input terminals (R, S, T) of the inverter.
	Make sure that the inverter and motor are properly grounded.
Motor wiring confirmation	Confirm that the motor is correctly connected to the output terminals (U, V, W) of the inverter, and the motor wiring is secured.
Confirmation of braking unit and braking resistor	Make sure that the braking resistor and braking unit are connected as shown in Fig. 3-3 (use the dynamic braking resistor if necessary during operation).
Control terminal wiring confirmation	Check whether the control terminals of the inverter are correctly and reliably connected to other controls.
Control terminal status confirmation	Make sure that the control terminal circuit of the inverter is disconnected to prevent operation upon powering on.
Mechanical load confirmation	Confirm that the machinery is in the no-load state and free of danger in operation.

5.3 Inverter Status Confirmation after Power-on

After the power supply is turned on, the control panel (keyboard) of the inverter displays the following information in the normal status.

Status	Display	Note
During normal operation	0	The digital setting 0Hz is displayed by default
Protection	Protection code in character or Exx format	The protection code is displayed in the protection status. See the protection measures in Chapter 6.

5.4 Precautions for Application Macro Setting

F16.00 is an industry application macro option. Select the application macro according to the specific application, and press the Enter key to automatically restore default settings. See Chapter 10 for details on application macros.

5.5 Start and Stop Control

Function code	Function code name	Parameter description	Default setting	Attribute
F00.02	Options of command source	0: keyboard control 1: Terminal control 2: Communication control	0	○

F00.02=0: keyboard control

The start and stop of the inverter are controlled by the RUN key, STOP key on the keyboard. In the case of no trip protection, press the RUN key to enter the running status. If the green LED indicator above the RUN key is normally ON, it indicates that the inverter is running. If this indicator is flickering, it indicates that the inverter is in the status of deceleration to stop.

F00.02=1: terminal control

The inverter start and stop are controlled by the start and stop control terminals defined by the function code F02.00 to F02.04. Terminal control is dependent on F00.03.

F00.02=2: communication control

The inverter start and stop are controlled by the host through the RS485 communication port.

Function code	Function code name	Parameter description	Default setting	Attribute
F04.00	Start-up method	0: direct start 1: start of speed tracking	0	○

F04.00=0: direct start

The inverter is started at the starting frequency, following the DC braking (not suitable when F04.04=0) and pre-excitation (not suitable when F04.07=0). The starting frequency will change to the set frequency after the holding time.

F04.00=1: start with speed tracking

The inverter is smoothly started at the current rotating frequency of the motor, following the speed tracking.

Function code	Function code name	Parameter description	Default setting	Attribute
F04.19	Stop mode	0: Slow down to stop 1: Free stop	0	○

F04.19=0: deceleration to stop

The motor decelerates to stop according to the set deceleration time [default setting: based on F00.15 (deceleration time 1)].

F04.19=1: free stop

When there is a valid stop command, the inverter will stop output immediately, and the motor will freely coast to stop. The stop time depends on the inertia of the motor and load.

5.5.1 Terminal control of start and stop

Function code	Function code name	Parameter description	Default setting	Attribute
F00.03	Options of terminal control mode	0: terminal RUN (running) and F/R (forward/reverse) 1: terminal RUN (forward) and F/R (reverse) 2: terminal RUN (forward), Xi (stop) and F/R (reverse) 3: terminal RUN (running), Xi (stop) and F/R (forward/reverse)	0	○

Terminal RUN: Xi terminal is set to “1: terminal RUN”

Terminal F/R: Xi terminal is set to “2: running direction F/R”

Terminal control can be divided into two types: two-line control and three-line control.

Two-line control:

F00.03=0: the terminal RUN is enabled and the terminal F/R controls forward/reverse running.

Enable/Disable the terminal RUN to control the start and stop of the inverter, and the terminal F/R to control the forward/reverse running. If F00.21 is set to 1 and reverse running is disabled, the F/R terminal will not be available. When the mode of deceleration to stop is selected, the logic diagram is as shown in Fig. 5-2 (b).

F00.03=1: the terminal RUN controls forward running, and the terminal F/R is in the reverse mode.

Enable/Disable the terminal RUN to control the forward running and stop of the inverter, and the terminal F/R to control the reverse running and stop. When the terminals RUN and F/R are enabled simultaneously, the inverter will be stopped. If reverse running is disabled, the terminal F/R will not be available. When the mode of deceleration to stop is selected, the logic of forward/reverse running is as shown in Fig. 5-2 (d):

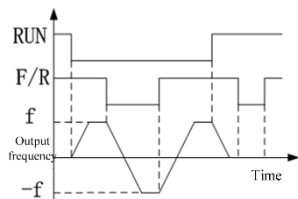
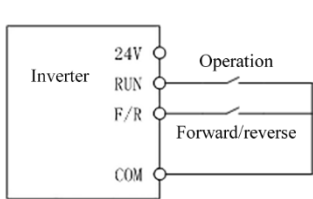

(a) Wiring diagram of two-line control (F00.03=0) (b) F04.19=0, F00.03=0, run the forward/reverse logic

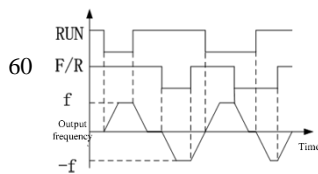
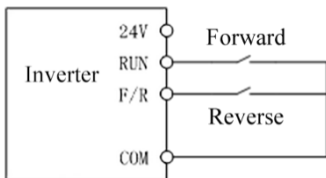

(c) F00.03=1 two-line control wiring

(d) F04.19=0, F00.03=1: forward/reverse running logic

Fig. 5-2 Two-line Control

When the start/stop value of F00.03 is set to 0 or 1, even if the terminal RUN is available, the inverter can be stopped by pressing the STOP key  or sending an external stop command to the terminal. In this case, the inverter will not be in the running status until the terminal RUN is disabled and then enabled.

Three-line control:

F00.03=2: the terminal RUN controls forward running, the terminal Xi is for stop, and the terminal F/R is in the reverse status.

The terminal RUN is normally ON for forward running, and the terminal F/R is normally ON for reverse running, with valid pulse edges. The terminal Xi is normally closed for stop, with the valid level. When the inverter is in the running status, press Xi to stop it. In the case of deceleration to stop (F04.19=0), the logic diagram is as shown in Fig. 5-3 Fig. 7-7(b). The terminal Xi is for “three-line running and stop control” as defined by F02.00 to F02.04.

F00.03=3: the terminal RUN is for running, Xi for stop and F/R for forward/reverse control.

The terminal RUN is normally ON for running, with the valid pulse edge, F/R for forward/reverse switching (forward in the OFF status and reverse in the ON status), and Xi is normally OFF for stop, with the valid level. In the case of deceleration to stop (F04.19=0), the logic diagram is as shown in Fig. 5-3(d).

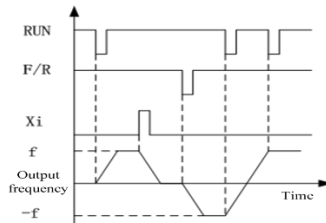
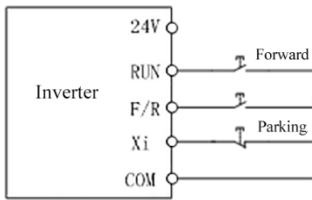

(a) Wiring diagram of three-line control (F00.03=2)

(b) Forward/reverse control logic (F04.19=0, F00.03=2)

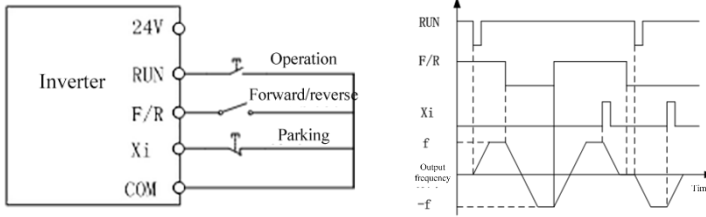



Fig. 5-3 Three-line Control

 The three-line control logic of the EM730/EM730E series inverter is consistent with the conventional electrical control. The keys and knob switches should be used correctly as shown in the schematic diagram. Otherwise, operation errors may be caused.

5.6 Common Process Parameters of Inverter

Function code	Function code name	Parameter description	Unit	Default setting	Attribute
F00.01	Drive control mode of motor 1	0: V/F control (VVF) 1: Speed sensorless vector control (SVC)		0	○
F00.04	Options of main frequency source A	0: digital frequency setting F00.07 1: AI1 2: AI2 5: high frequency pulse input (X5) 6: Percentage setting of main frequency communication 7: Direct setting of main frequency communication 8: digital potentiometer setting		0	○
F00.07	Digital frequency setting	0.00 to maximum frequency F00.16	Hz	0.00	●
F00.14	Acceleration time 1	0.00~650.00 (F15.13=0)	s	15.00	●
F00.15	Deceleration time 1	0.00~650.00 (F15.13=0)	s	15.00	●
F00.16	Maximum frequency	1.00~600.00	Hz	50.00	○
F00.18	Upper frequency limit	Lower frequency limit F00.19 to maximum frequency F00.16	Hz	50.00	●
F00.19	Lower frequency limit	0.00 to upper frequency limit F00.18	Hz	0.00	●
F00.21	Reverse control	0: Allow forward/reverse running 1: Prohibit reversing		0	○

Note: Common process parameters may also include the input and output terminal function

settings. Refer to the F02 and F03 groups in the function table.

5.7 Motor Parameter Identification

For the better control performance, motor parameters must be identified.

Identification Method	Application	Identification Effect
F01.34=01 Static self-learning of asynchronous motor	It is applied where the motor and load cannot be separated easily and rotary self-learning is not allowed.	General
F01.34=11 Static self-learning of synchronous motor		
F01.34=02 Rotary self-learning of asynchronous motor	It is applied when the motor and load can be separated easily. Before operation, the motor shaft should be separated from the load. The motor under load must not be put into rotary self-learning.	Optimal
F01.34=12 Rotary self-learning of synchronous motor		

- Prior to self-identification, make sure that the motor is stopped; otherwise, self-identification cannot be performed properly.

5.7.1 Parameter identification steps

- Where the motor and load can be separated, the mechanical load and motor should be completely separated in the power-off status.
- After the power-on, set the command source of the inverter to keyboard control (F00.02=0).
- Enter the nameplate parameters of the motor accurately.

Motor	Corresponding Parameter
Motor 1	F01.00 Motor type F01.01 Rated power of electric motor F01.02 Rated voltage of motor F01.03 Rated current of motor F01.04 Rated frequency of motor F01.05 Rated speed F01.06: Motor winding connection
Motor 2	F14.00 Motor type F14.01 Rated power of electric motor F14.02 Rated voltage of motor F14.03 Rated current of motor F14.04 Rated frequency of motor F14.05 Rated speed F14.06: Motor winding connection

- For the asynchronous motor:
Set F01.34=1 for confirmation and press the RUN key. The inverter will start the static self-identification of the motor.
Or, set F01.34=2 and press the RUN key. The inverter will start the rotary self-identification of the motor.
- For the synchronous motor:
Set F01.34=11 and press the RUN key. The inverter will start the static self-identification of the motor.

Or, set F01.34=12 and press the RUN key. The inverter will start the rotary self-identification of the motor.

- It takes about two minutes to complete the self-identification of the motor. Then the system will return to the initial power-on status from the “tune” interface.
- If multiple motors are used in parallel, the rated power and rated current input of the motors should be the sum of power and current of these motors.

If two motors are used alternately, the parameters of the motor 2 in the F14 group need to be set separately, and identified based on F14.34.

Chapter 6 Function Code Table

6.1 Description of Function Code Table

The function codes of the EM730/EM730E series inverter (hereinafter referred to as the “function codes”) are divided into 24 groups in Table 6-2, and each group contains several function codes. Among them, the F18 group is a monitoring parameter group used to view the inverter status; the F19 group is a protection record group used to view the details of the last three protections; and other groups are parameter setting groups to meet different functional requirements.

Table 6-2 Introduction to Function Code Groups

F00	Basic function parameter group	P66;P129	F01	Parameter group of motor 1	P69;P147
F02	Input terminal function group	P70;P152	F03	Output terminal function group	P74;P166
F04	Start/stop control parameter group	P77;P177	F05	V/F control parameter group	P79;P185
F06	Vector control parameter group	P81;P191	F07	Protection function setting group	P87;P199
F08	Multi-segment speed and simple PLC	P89;P207	F09	PID function group	P94;P217
F10	Communication function group	P98;P231	F11	User-selected parameter group	P99;P236
F12	Keyboard and display function group	P101;P238	F13	Torque control parameter group	P104;P243

F14	Parameter group of motor 2	P106;P250	F15	Auxiliary function group	P113;P253
F16	Customization function group	P116;P265	F17	Virtual I/O function group	P117;P272
F18	Monitoring parameter group	P120;P276	F19	Protection record group	P123;P279
F27	Winding/unwinding application macro parameter group				

- ★ Some parameters of the current series are reserved, and their readings are 0. Some options of parameters are reserved and settable, but this may result in abnormal operation of the inverter. Please avoid misuse of such parameters.

The table below provides the details of the function code table.

Function code	F00.00 to F99.99: function code number					
Function code name	Full name of the function code. “Reserved” means that the corresponding function code is temporarily reserved and has no practical meaning.					
Parameter description	Brief description of the function code. It is mainly divided into the following three types:					
	Integral	The value of the integral function code represents the current parameter selection or meaning.				
	Quantifier	The ones, tens, hundreds, thousands and tens of thousands represent one option or the current meaning of the function code.				
	Binary	Each binary bit represents one option or the current meaning of the function code.				
Unit	Metric units of the function code. The units and abbreviations are as follows:					
	Hz	Hertz	kW	kilowatt	us	Microsecond
	kHz	Kilohertz	kWh	Kilowatt-hour ★	ms	Millisecond
	%	Percent★	MWh	Megawatt hour	s	Second
	V	Volt	mΩ	Milliohm	min	min
	A	Amp	mH	Millihenry	h	h
	rpm	rpm	℃	℃	m	m
★: %: The benchmarks are different for physical quantities; kWh: Kilowatt hour, commonly known as the degree.						

Default setting	Function code settings before delivery, or values after parameter restoration (F12.14=1). This is mainly described by the following three categories.	
	Number (e.g. 50.00)	Refer to each power segment. The function code is set to the current value by default.
	Depending on the motor type	The default setting of this function code varies based on the power segments.
	XXX	The default setting of this function code varies based on the power segments and batches.
Attribute	Change attribute of the function code (permission and condition of change), as described below:	
	●	Changeable in running: The current function code can be changed in any status.
	○	Non-changeable in running: The current function code can be changed except in the running status.
	×	Read-only: The current function code cannot be changed in any status.

6.2 Table of functional parameters

Function code	Function code name	Parameter description	Unit	Default setting	Attribute
F00	Basic function parameter group				
F00.00	Reserved				
F00.01	Drive control mode of motor 1	0: V/F control (VVF) 1: Speed sensorless vector control (SVC)		0	○
F00.02	Options of command source	0: keyboard control (LOC/REM indicator: ON) 1: terminal control (LOC/REM indicator: OFF) 2: communication control (LOC/REM indicator: flicker)		0	○
F00.03	Options of terminal control mode	0: terminal RUN (running) and F/R (forward/reverse) 1: terminal RUN (forward) and F/R (reverse) 2: terminal RUN (forward), Xi (stop) and F/R (reverse) 3: terminal RUN (running), Xi (stop) and F/R (forward/reverse)		0	○
F00.04	Options of main frequency source A	0: digital frequency setting F00.07 1: AI1 2: AI2 3: retention 4: retention 5: high frequency pulse input (X5) 6: main frequency communication setting		8	○

User Manual of EM730/EM730E Series Inverter

		(percentage) 7: main frequency communication setting (direct frequency) 8: digital potentiometer setting			
F00.05	Options of auxiliary frequency source B	0: digital frequency setting F00.07 1: AI1 2: AI2 3: retention 4: retention 5: high frequency pulse input (X5) 6: auxiliary frequency communication setting (percentage) 7: auxiliary frequency communication setting (direct frequency) 8: digital potentiometer setting 9: retention 10: process PID 11: simple PLC		0	○
F00.06	Options of frequency source	0: main frequency source A 1: auxiliary frequency source B 2: main and auxiliary operation results 3: switching between main frequency source A and auxiliary frequency source B 4: switching between main frequency source A and main and auxiliary operation results 5: switching between auxiliary frequency source B and main and auxiliary operation results 6: Auxiliary frequency source B + feedforward calculation (winding application)		0	○
F00.07	Digital frequency setting	0.00 to maximum frequency F00.16	Hz	50.00	●
F00.08	Options of main and auxiliary operation	0: main frequency source A + auxiliary frequency source B 1: main frequency source A - auxiliary frequency source B 2: larger value of main and auxiliary frequency sources 3: smaller value of main and auxiliary frequency sources		0	○
F00.09	Reference options of auxiliary frequency source B in main and auxiliary operation	0: relative to the maximum frequency 1: Relative to main frequency source A		0	○
F00.10	Gain of main frequency source	0.0~300.0	%	100.0	●
F00.11	Gain of auxiliary frequency source	0.0~300.0	%	100.0	●

User Manual of EM730/EM730E Series Inverter

F00.12	Synthetic gain of main and auxiliary frequency sources	0.0~300.0	%	100.0	●
F00.13	Analog adjustment of synthetic frequency	0: synthetic frequency of main and auxiliary channels 1: AI1 * synthetic frequency of main and auxiliary channels 2: AI2 * synthetic frequency of main and auxiliary channels 3: retention 4: retention 5: High frequency pulse (PULSE) * synthetic frequency of main and auxiliary channels		0	○
F00.14	Acceleration time 1	0.00 - 650.00 (F15.13=0) 0.0 - 6500.0 (F15.13=1) 0 - 65000 (F15.13=2)	s	15.00	●
F00.15	Deceleration time 1	0.00 - 650.00 (F15.13=0) 0.0 - 6500.0 (F15.13=1) 0 - 65000 (F15.13=2)	s	15.00	●
F00.16	Maximum frequency	1.00~600.00/1.0~3000.0	Hz	50.00	○
F00.17	Options of upper frequency limit control	0: set by F00.18 1: AI1 2: AI2 3: retention 4: retention 5: high frequency pulse input (X5) 6: Communication setting (percentage) 7: Communication setting (direct frequency)		0	○
F00.18	Upper frequency limit	Lower frequency limit F00.19 to maximum frequency F00.16	Hz	50.00	●
F00.19	Lower frequency limit	0.00 to upper frequency limit F00.18	Hz	0.00	●
F00.20	Running direction	0: consistent direction 1: opposite direction		0	●
F00.21	Reverse control	0: Allow forward/reverse running 1: Prohibit reversing		0	○
F00.22	Duration of forward and reverse dead zone	0.00~650.00	s	0.00	●
F00.23	Carrier frequency	1.0-16.0 (rated power of the inverter: 0.75-4.00kW) 1.0-10.0 (rated power of the inverter: 5.50-7.50kW) 1.0 - 8.0 (rated power of inverter 11.00 - 45.00kW) 1.0 - 4.0 (rated power of inverter 55.00 - 90.00kW) 1.0-3.0 (rated power of inverter: 110.00 and above)	kHz	4.0 (0.75 and below) /2.0	●
F00.24	Automatic adjustment of carrier frequency	0: Invalid 1: valid 1 2: Valid 2		1	○

User Manual of EM730/EM730E Series Inverter

F00.25	Noise suppression of carrier frequency	0: Invalid 1: valid		0	○
F00.26	Noise suppression tone	20~200	Hz	40	●
F00.27	Noise suppression intensity	10~150	Hz	100	●
F00.28	Options of motor parameter group	0: parameter group of motor 1 1: parameter group of motor 2		0	○
F00.29	User password	0 - 65535		0	○
F00.31	Frequency resolution	0: 0.01Hz 1: 0.1Hz (speed unit: 10rpm)		0	○
F00.35	Power supply voltage selection	0: 380V 1: 440V		0	○
F01	Parameter group of motor 1				
F01.00	Motor type	0: ordinary asynchronous motor 1: variable-frequency asynchronous motor 2: permanent magnet synchronous motor		0	○
F01.01	Rated power of electric motor	0.10~650.00	kW	Depending on the motor type	○
F01.02	Rated voltage of motor	50~2000	V	Depending on the motor type	○
F01.03	Rated current of motor	0.01 to 600.00 (rated power of motor: ≤ 75 kW) 0.1 to 6000.0 (rated power of motor: > 75 kW)	A	Depending on the motor type	○
F01.04	Rated frequency of motor	0.01~600.00	Hz	Depending on the motor type	○
F01.05	Rated speed	1~60000	rpm	Depending on the motor type	○
F01.06	Motor winding connection	0:Y 1:Δ		Depending on the motor type	○
F01.07	Rated power factor of motor	0.600~1.000		Depending on the motor type	○
F01.08	Motor efficiency	30.0~100.0	%	Depending on the motor type	○
F01.09	Stator resistance of asynchronous motor	1-60000 (rated power of motor: ≤ 75 kW) 0.1-6000.0 (rated power of motor: > 75kW)	mΩ	Depending on the motor type	○
F01.10	Rotor resistance of asynchronous	1-60000 (rated power of motor: ≤ 75 kW)	mΩ	Depending	○

User Manual of EM730/EM730E Series Inverter

	motor	0.1-6000.0 (rated power of motor: > 75kW)		on the motor type	
F01.11	Leakage inductance of asynchronous motor	0.01 to 600.00 (rated power of motor: ≤ 75 kW) 0.001 to 60.000 (rated power of motor: > 75 kW)	mH	Depending on the motor type	○
F01.12	Mutual inductance of asynchronous motor	0.1 to 6000.0 (rated power of motor: ≤ 75 kW) 0.01 to 600.00 (rated power of motor: > 75 kW)	mH	Depending on the motor type	○
F01.13	No-load excitation current of asynchronous motor	0.01 to 600.00 (rated power of motor: ≤ 75 kW) 0.1 to 6000.0 (rated power of motor: > 75 kW)	A	Depending on the motor type	○
F01.14	Flux weakening coefficient 1 of asynchronous motor	10.00 - 100.00	%	87.00	○
F01.15	Flux weakening coefficient 2 of asynchronous motor	10.00 - 100.00	%	80.00	○
F01.16	Flux weakening coefficient 3 f asynchronous motor	10.00 - 100.00	%	75.00	○
F01.17	Flux weakening coefficient 4 f asynchronous motor	10.00 - 100.00	%	72.00	○
F01.18	Flux weakening coefficient 5 f asynchronous motor	10.00 - 100.00	%	70.00	○
F01.19	Stator resistance of synchronous motor	1-60000 (rated power of motor: ≤75kW) 0.1 to 6000.0 (rated power of motor: > 75 kW)	mΩ	Depending on the motor type	○
F01.20	d-axis inductance of synchronous motor	0.01 to 600.00 rated power of motor: ≤ 75 kW) 0.001 to 60.000 (rated power of motor: > 75 kW)	mH	Depending on the motor type	○
F01.21	q-axis inductance of synchronous motor	0.01~600.00 (rated power of motor: ≤ 75 kW) 0.001~60.000 (rated power of motor: > 75kW)	mH	Depending on the motor type	○
F01.22	Counter electromotive force of synchronous motor	10.0-2000.0 (counter electromotive force of rated speed)	V	Depending on the motor type	○
F01.23	Initial electrical angle of synchronous motor	0.0-359.9 (valid for synchronous motor)			○
F01.34	Motor parameter self-learning	00: No operation 01: static self-learning of asynchronous motor 02: rotation self-learning of asynchronous motor 03: inertia self-learning of asynchronous motor 11: static self-learning of synchronous motor 12: rotary self-learning of synchronous motor 13: encoder self-learning of synchronous motor		00	○
F02	Input terminal function group				

User Manual of EM730/EM730E Series Inverter

F02.00	Options of X1 digital input function	0: no function 1: terminal running (RUN)		1	○
F02.01	Options of X2 digital input function	2: running direction (F/R) 3: stop control in three-line operation		2	○
F02.02	Options of X3 digital input function	4: forward jog (FJOG) 5: reverse jog (RJOG)		11	○
F02.03	Options of X4 digital input function	6: terminal UP 7: terminal DOWN		12	○
F02.04	Options of X5 digital input function	8: clear UP/DOWN offset 9: free stop		13	○
F02.07	Options of AI1 digital input function	10: Reset protection 11: multi-segment speed terminal 1 12: multi-segment speed terminal 2 13: multi-segment speed terminal 3 14: multi-segment speed terminal 4 15: multi-segment PID terminal 1 16: multi-segment PID terminal 2 17: multi-segment torque terminal 1 18: multi-segment torque terminal 2 19: acceleration and deceleration time terminal 1 20: acceleration and deceleration time terminal 2 21: Acceleration and deceleration prohibition 22: operation pause 23: External protection input 24: Switching of RUN command to keyboard 25: switching of RUN command to communication 26: Frequency source switching 27: clearing of regular running time 28: speed control/torque control switching 29: torque control prohibition 30: motor 1/motor 2 switching 31: resetting of simple PLC status (running from the first segment, with the running time cleared) 32: simple PLC time pause (keep running at current segment) 33: retention 34: counter input ($\leq 250\text{Hz}$) 35: high-speed count input ($\leq 100\text{kHz}$, only valid for X5) 36: count clearing 37: length counter input ($\leq 250\text{Hz}$) 38: High-speed length counting input ($\leq 100\text{kHz}$, only valid for X5) 39: Reset length (clear by meter) 40: Pulse input ($\leq 100\text{kHz}$, only valid for X5)		0	○
F02.08	Options of AI2 digital input function			0	○

		41: process PID pause 42: process PID integral pause 43: PID parameter switching 44: PID positive/negative switching 45: stop and DC braking 46: DC braking at stop 47: immediate DC braking 48: fastest deceleration to stop 49: retention 50: external stop 51: switching of main frequency source to digital frequency setting 52: switching of main frequency source to AI1 53: Switching of main frequency source to AI2 54: retention 55: Switching of main frequency source to high-frequency pulse input 56: switching of main frequency source to communication setting 57: inverter enabling 68: Disable reversal 69: prohibit reversing 121: External material cutoff signal 122: Wiring detection signal 123: Brake reset terminal																			
F02.15	Positive/negative logic 1 of digital input terminal	<table border="1"> <tr> <td>D7</td><td>D6</td><td>D5</td><td>D4</td><td>D3</td><td>D2</td><td>D1</td><td>D0</td> </tr> <tr> <td>*</td><td>*</td><td>*</td><td>X5</td><td>X4</td><td>X3</td><td>X2</td><td>X1</td> </tr> </table> 0: positive logic, valid in the closed state/invalid in the open state 1: Negative logic, invalid in the closed state/valid in the open state	D7	D6	D5	D4	D3	D2	D1	D0	*	*	*	X5	X4	X3	X2	X1		00000	○
D7	D6	D5	D4	D3	D2	D1	D0														
*	*	*	X5	X4	X3	X2	X1														
F02.16	Positive/negative logic 2 of digital input terminal	<table border="1"> <tr> <td>D7</td><td>D6</td><td>D5</td><td>D4</td><td>D3</td><td>D2</td><td>D1</td><td>D0</td> </tr> <tr> <td>*</td><td>*</td><td>*</td><td>*</td><td>*</td><td>*</td><td>AI2</td><td>AI1</td> </tr> </table> 0: positive logic, valid in the closed state/invalid in the open state 1: Negative logic, invalid in the closed state/valid in the open state	D7	D6	D5	D4	D3	D2	D1	D0	*	*	*	*	*	*	AI2	AI1		00	○
D7	D6	D5	D4	D3	D2	D1	D0														
*	*	*	*	*	*	AI2	AI1														
F02.17	Filtering times of digital input terminal	0-100, 0: no filtering; n: sampling every n ms		2	○																
F02.18	X1 valid delay time	0.000-30.000	s	0.000	●																
F02.19	X1 invalid delay time	0.000-30.000	s	0.000	●																
F02.20	X2 valid delay time	0.000-30.000	s	0.000	●																
F02.21	X2 invalid delay time	0.000-30.000	s	0.000	●																

User Manual of EM730/EM730E Series Inverter

F02.22	X3 valid delay time	0.000-30.000	s	0.000	●
F02.23	X3 invalid delay time	0.000-30.000	s	0.000	●
F02.24	X4 valid delay time	0.000-30.000	s	0.000	●
F02.25	X4 invalid delay time	0.000-30.000	s	0.000	●
F02.26	Minimum input pulse frequency	0.00 to maximum input pulse frequency F02.28	kHz	0.00	●
F02.27	Minimum input setting	-100.0 - +100.0	%	0.0	●
F02.28	Maximum input pulse frequency	0.01-100.00	kHz	50.00	●
F02.29	Maximum input setting	-100.0 - +100.0	%	100.0	●
F02.30	Pulse input filtering time	0.00 - 10.00	s	0.10	●
F02.31	Options of analog input function	Ones place: AI1 0: analog input 1: digital input (0 below 1V, 1 above 3V, the same as last time under 1-3V) Tens place: AI2 0: analog input 1: digital input (the same as above)		00B	○
F02.32	Options of analog input curve	Ones place: Options of AI1 curve 0: curve 1 1: curve 2 2: curve 3 3: curve 4 Tens place: AI2 curve selection 0: curve 1 1: curve 2 2: curve 3 3: curve 4		10D	○
F02.33	Minimum input of curve 1	0.00 - F02.35	V	0.10	●
F02.34	Minimum input setting of curve 1	-100.0 - +100.0	%	0.0	●
F02.35	Maximum input of curve 1	F02.33~10.00V	V	9.90	●
F02.36	Maximum input setting of curve 1	-100.0 - +100.0	%	100.0	●
F02.37	Minimum input of curve 2	-10.00V~F02.39	V	0.10	●
F02.38	Minimum input setting of curve 2	-100.0 - +100.0	%	0.0	●
F02.39	Maximum input of curve 2	F02.37~10.00V	V	9.90	●
F02.40	Maximum input setting of curve 2	-100.0 - +100.0	%	100.0	●

User Manual of EM730/EM730E Series Inverter

F02.41	Minimum input of curve 3	0.00V - F02.43	V	0.10	●
F02.42	Minimum input setting of curve 3	-100.0 - +100.0	%	0.0	●
F02.43	Input of inflection point 1 of curve 3	F02.41 - F02.45	V	2.50	●
F02.44	Input setting of inflection point 1 of curve 3	-100.0 - +100.0	%	25.0	●
F02.45	Input of inflection point 2 of curve 3	F02.43 - F02.47	V	7.50	●
F02.46	Input setting of inflection point 2 of curve 3	-100.0 - +100.0	%	75.0	●
F02.47	Maximum input of curve 3	F02.45 - 10.00	V	9.90	●
F02.48	Maximum input setting of curve 3	-100.0 - +100.0	%	100.0	●
F02.49	Minimum input of curve 4	-10.00 - F02.51	V	-9.90	●
F02.50	Minimum input setting of curve 4	-100.0 - +100.0	%	-100.0	●
F02.51	Input of inflection point 1 of curve 4	F02.49 - F02.53	V	-5.00	●
F02.52	Input setting of inflection point 1 of curve 4	-100.0 - +100.0	%	-50.0	●
F02.53	Input of inflection point 2 of curve 4	F02.51 - F02.55	V	5.00	●
F02.54	Input setting of inflection point 2 of curve 4	-100.0 - +100.0	%	50.0	●
F02.55	Maximum input of curve 4	F02.53 - 10.00	V	9.90	●
F02.56	Maximum input setting of curve 4	-100.0 - +100.0	%	100.0	●
F02.57	AI1 filtering time	0.00 - 10.00	s	0.10	●
F02.58	AI2 filtering time	0.00 - 10.00	s	0.10	●
F02.61	AD hysteresis code	2 - 50		2	○
F02.62	Selection of analog input AI1 type	0: 0~10V 3: -10~10V 4: 0~5V		0	○
F02.63	Selection of analog input AI2 type	0: 0~10V 1: 4~20mA 2: 0~20mA 4: 0~5V		0	
F02.66	Selection of AI2 current input impedance	0: 500Ω 1: 250Ω		0	○
F03	Output terminal function group				
F03.00	Options of Y1 output function	0: no output		1	○
F03.02	Options of R1 output function (EA-EB-EC)	1: inverter running (RUN) 2: up to output frequency (FAR) 3: output frequency detection FDT1 4: output frequency detection FDT2 5: reverse running (REV)		7	○

		<p>6: jog 7: inverter protection 8: inverter ready to run (READY) 9: reach the upper frequency limit 10: reach the lower frequency limit 11: valid current limit 12: valid overvoltage stall 13: complete simple PLC cycle 14: reach the set count value 15: reach the specified count value 16: Length reached (in meters) 17: motor overload pre-alarm 18: inverter overheat pre-alarm 19: reach the upper limit of PID feedback 20: reach the lower limit of PID feedback 21: analog level detection ADT1 22: analog level detection ADT2 24: undervoltage state 26: up to the set time 27: zero-speed running 38: off-load 47: PLC output 67: Brake control 68: Material cutoff detection output 69: FDT1 lower limit (pulse) 70: FDT2 lower limit (pulse) 71: FDT1 lower limit (pulse, invalid in JOG) 72: FDT2 lower limit (pulse, invalid in JOG) 73: output overcurrent</p>																			
F03.05	Options of output signal type	<table border="1"> <tr> <td>D7</td><td>D6</td><td>D5</td><td>D4</td><td>D3</td><td>D2</td><td>D1</td><td>D0</td> </tr> <tr> <td>*</td><td>*</td><td>*</td><td>*</td><td>*</td><td>R1</td><td>*</td><td>Y1</td> </tr> </table> <p>0: level 1: single pulse</p>	D7	D6	D5	D4	D3	D2	D1	D0	*	*	*	*	*	R1	*	Y1		0*0	○
D7	D6	D5	D4	D3	D2	D1	D0														
*	*	*	*	*	R1	*	Y1														
F03.06	Positive/negative logic of digital output	<table border="1"> <tr> <td>D7</td><td>D6</td><td>D5</td><td>D4</td><td>D3</td><td>D2</td><td>D1</td><td>D0</td> </tr> <tr> <td>*</td><td>*</td><td>*</td><td>*</td><td>*</td><td>R1</td><td>*</td><td>Y1</td> </tr> </table> <p>0: positive logic, valid in the closed state/invalid in the open state 1: Negative logic, invalid in the closed state/valid in the open state</p>	D7	D6	D5	D4	D3	D2	D1	D0	*	*	*	*	*	R1	*	Y1		0*0	○
D7	D6	D5	D4	D3	D2	D1	D0														
*	*	*	*	*	R1	*	Y1														
F03.08	Output status control in jog	<table border="1"> <tr> <td>D7</td><td>D6</td><td>D5</td><td>D4</td><td>D3</td><td>D2</td><td>D1</td><td>D0</td> </tr> <tr> <td>*</td><td>*</td><td>*</td><td>REV</td><td>FDT2</td><td>FDT1</td><td>FAR</td><td>RUN</td> </tr> </table>	D7	D6	D5	D4	D3	D2	D1	D0	*	*	*	REV	FDT2	FDT1	FAR	RUN		00000	○
D7	D6	D5	D4	D3	D2	D1	D0														
*	*	*	REV	FDT2	FDT1	FAR	RUN														

User Manual of EM730/EM730E Series Inverter

		0: valid in jogging 1: invalid in jogging																			
F03.09	Y1 valid delay time	0.000~30.000	s	0.000	●																
F03.10	Y1 invalid delay time	0.000~30.000	s	0.000	●																
F03.13	R1 valid delay time	0.000~30.000	s	0.000	●																
F03.14	R1 invalid delay time	0.000~30.000	s	0.000	●																
F03.17	Single pulse time of Y1 output	0.001~30.000	s	0.250	●																
F03.19	Single pulse time of R1 output	0.001~30.000	s	0.250	●																
F03.21	Options of analog output M1	0: running frequency (absolute value) 1: set frequency (absolute value) 2: output torque (absolute value) 3: set torque (absolute value) 4: output current 5: Output voltage 6: bus voltage 7: output power 8: AI1 9: AI2 12: High-frequency pulse input (with 100% corresponding to 100.00kHz) 13: Communication setting 1 14: count value 15: length value 16: PID output 18: PID feedback 19: PID setting 30: Communication setting 2		0	○																
F03.27	M1 output bias	-100.0~100.0	%	0.0	●																
F03.28	M1 output gain	-10.000~10.000		1.000	●																
F03.31	Control logic options of PLC output terminal	<table border="1"> <tr> <td>D7</td> <td>D6</td> <td>D5</td> <td>D4</td> <td>D3</td> <td>D2</td> <td>D1</td> <td>D0</td> </tr> <tr> <td>*</td> <td>*</td> <td>*</td> <td>*</td> <td>*</td> <td>R1</td> <td>*</td> <td>Y1</td> </tr> </table>	D7	D6	D5	D4	D3	D2	D1	D0	*	*	*	*	*	R1	*	Y1		0*0	○
		D7	D6	D5	D4	D3	D2	D1	D0												
*	*	*	*	*	R1	*	Y1														
		0: Output 1: no output																			

User Manual of EM730/EM730E Series Inverter

F03.34	Selection of analog output M1 type	0: 0~10V 1: 4~20mA 2: 0~20mA		0	○
--------	------------------------------------	------------------------------------	--	---	---

F04 Start/stop control parameter group					
F04.00	Start-up method	0: direct start 1: start of speed tracking		0	○
F04.01	Start frequency	0.00 - 10.00	Hz	0.00	○
F04.02	Start frequency hold time	0.00-60.00, 0.00 is invalid	s	0.00	○
F04.03	Starting current of DC braking	0.0~100.0 (100.0 = Rated current of motor)	%	100.0	○
F04.04	Starting time of DC braking	0.00~30.00 0.00: invalid	s	0.00	○
F04.06	Pre-excitation current	50.0-500.0 (100.0 = no-load current)	%	100.0	○
F04.07	Pre-excitation time	0.00 - 10.00	s	0.10	○
F04.08	Speed tracking mode	Ones place: Tracking start frequency 0: maximum frequency 1: stop frequency 2: power frequency Tens place: Selection of search direction 0: search only in command direction 1: Search in the opposite direction if the speed cannot be found in the command direction		0	○
F04.10	Deceleration time of speed tracking	0.1 - 20.0	s	2.0	○
F04.11	Speed tracking current	30.0-150.0 (100.0 = rated current of inverter)	%	50.0	○
F04.12	Speed tracking compensation gain	0.00 - 10.00		1.00	○

User Manual of EM730/EM730E Series Inverter

F04.14	Acceleration and deceleration mode	0: linear acceleration and deceleration 1: acceleration and deceleration of continuous S curve 2: acceleration and deceleration of intermittent S curve		0	○
F04.15	Starting time of S curve in acceleration	0.00~30.00(F15.13=0) 0.0~300.0(F15.13=1) 0~3000(F15.13=2)	s	1.00	●
F04.16	Ending time of S curve in acceleration	0.00~30.00(F15.13=0) 0.0~300.0(F15.13=1) 0~3000(F15.13=2)	s	1.00	●
F04.17	Starting time of S curve in deceleration	0.00~30.00(F15.13=0) 0.0~300.0(F15.13=1) 0~3000(F15.13=2)	s	1.00	●
F04.18	Ending time of S curve in deceleration	0.00~30.00(F15.13=0) 0.0~300.0(F15.13=1) 0~3000(F15.13=2)	s	1.00	●
F04.19	Stop mode	0: slow down to stop 1: free stop		0	○
F04.20	Starting frequency of DC braking in stop	0.00Hz to maximum frequency F00.16	Hz	0.00	○
F04.21	DC braking current in stop	0.0~100.0 (100.0 = Rated current of motor)	%	50.0%	○
F04.22	DC braking time in stop	0.00~30.00 0.00: invalid	s	0.00	○
F04.23	Demagnetization time for DC braking in stop	0.00 - 30.00	s	0.50	○
F04.24	Flux braking gain	100-150 (100: no flux braking)		100	○
F04.26	Start mode after protection/free stop	0: start according to F04.00 setting mode 1: start of speed tracking		0	○
F04.27	Second confirmation	0: Not required for confirmation 1: to be confirmed		0	○

User Manual of EM730/EM730E Series Inverter

	of terminal start command				
F04.29	Zero speed check frequency	0.00 - 5.00	Hz	0.25	●
F04.30	Initial magnetic pole search mode of synchronous motor	0: Invalid 1: Mode 1		0	●
F05	V/F control parameter group				
F05.00	V/F curve setting	0: straight line V/F 1: multi-point broken line V/F 2: 1.3-power V/F 3: 1.7-power V/F 4: square V/F 5: VF complete separation mode ($U_d = 0, U_q = K * t =$ voltage of separation voltage source) 6: VF semi-separation mode ($U_d = 0, U_q = K * t = F/Fe * 2 *$ voltage of separation voltage source)		0	○
F05.01	Frequency point F1 of multi-point VF	0.00 - F05.03	Hz	0.50	●
F05.02	Voltage point V1 of multi-point VF	0.0~100.0 (100.0 = Rated voltage)	%	1.0	●
F05.03	Frequency point F2 of multi-point VF	F05.01 ~ F05.05	Hz	2.00	●
F05.04	Voltage point V2 of multi-point VF	0.0-100.0	%	4.0	●
F05.05	Frequency point F3 of multi-point VF	F05.03 to rated frequency of motor (reference frequency)	Hz	5.00	●

User Manual of EM730/EM730E Series Inverter

F05.06	Voltage point V3 of multi-point VF	0.0-100.0	%	10.0	●
F05.07	Voltage source of VF separation mode	0: digital setting of VF separation voltage 1: AI1 2: AI2 4: High-frequency pulse (X5) 5: PID 6: Communication setting Note: 100% is the rated voltage of the motor.		0	○
F05.08	Digital setting of VF separation voltage	0.0-100.0 (100.0 = rated voltage of motor)	%	0.0	●
F05.09	Rise time of VF separation voltage	0.00 - 60.00	s	2.00	●
F05.10	Compensation gain of V/F stator voltage drop	0.00 - 200.00	%	100.00	●
F05.11	V/F slip compensation gain	0.00 - 200.00	%	100.00	●
F05.12	V/F slip filtering time	0.00 - 10.00	s	1.00	●
F05.13	Oscillation suppression gain	0 - 10000		100	●
F05.14	Oscillation suppression cutoff frequency	0.00-600.00	Hz	55.00	●
F05.15	Droop control frequency	0.00 - 10.00	Hz	0.00	●
F05.16	Energy saving rate	0.00 - 50.00	%	0.00	●
F05.17	Energy saving action time	1.00 - 60.00	s	5.00	●

F05.18	Flux compensation gain of synchronous motor	0.00~500.00	%	0.00	●
F05.19	Filtering time constant of flux compensation of synchronous motor	0.00 - 10.00	s	0.50	●
F05.20	Change rate of VF separate power supply setting	-500.0~+500.0	%	0.0	●
F06	Vector control parameter group				
F06.00	Speed proportional gain ASR_P1	0.00-100.00		12.00	●
F06.01	Speed integral time constant ASR_T1	0.000-30.000 0.000: no integral	s	0.200	●
F06.02	Speed proportional gain ASR_P2	0.00-100.00		8.00	●
F06.03	Speed integral time constant ASR_T2	0.000-30.000 0.000: no integral	s	0.300	●
F06.04	Switching frequency 1	0.00 to switching frequency 2	Hz	5.00	●
F06.05	Switching frequency 2	Switching frequency 1 to maximum frequency F00.16	Hz	10.00	●
F06.06	No-load current gain	50.0~300.0	%	100.0	●
F06.07	Filtering time constant of speed loop	0.000 - 0.100	s	0.001	●

User Manual of EM730/EM730E Series Inverter

	output				
F06.08	Vector control slip gain	50.00-200.00	%	100.00	●
F06.09	Upper limit source selection of speed control torque	0: set by F06.10 and F06.11 1: AI1 2: AI2 3: retention 4: retention 5: Communication setting (percentage) 6: the larger of AI1 and AI2 7: The smaller of AI1 and AI2		0	○
F06.10	Upper limit of speed control motor torque	0.0 - 250.0	%	165.0	●
F06.11	Upper limit of speed control brake torque	0.0 - 250.0	%	165.0	●
F06.12	Excitation current proportional gain ACR-P1	0.00-100.00		0.50	●
F06.13	Excitation current integral time constant ACR-T1	0.00-600.00 0.00: no integral	ms	10.00	●
F06.14	Torque current proportional gain ACR-P2	0.00-100.00		0.50	●
F06.15	Torque current integral time constant ACR-T2	0.00-600.00 0.00: no integral	ms	10.00	●
F06.17	SVC zero-frequen	0: braking 1: not processed		2	○

	cy processing	2: seal the tube			
F06.18	SVC zero-frequency braking current	50.0-400.0 (100.0 is the no-load current of the motor)	%	100.0	○
F06.20	Voltage feedforward gain	0 - 100	%	0	●
F06.21	Flux weakening control options	0: Invalid 1: direct calculation 2: automatic adjustment		2	○
F06.22	Flux weakening voltage	70.00-100.00	%	95.00	●
F06.23	Maximum field weakening current of synchronous motor	0.0-150.0 (100.0 is the rated current of the motor)	%	100.0	●
F06.24	Proportional gain of flux weakening regulator	0.00 - 10.00		0.50	●
F06.25	Integral time of flux weakening regulator	0.01 - 60.00	s	2.00	●
F06.26	MTPA control option of synchronous motor	0: Invalid 1: valid		1	○
F06.27	Self-learning gain at initial position	0 - 200	%	100	●
F06.28	Frequency of low frequency band of injection current	0.00-100.00 (100.00 is the rated frequency of the motor)	%	10.00	●

User Manual of EM730/EM730E Series Inverter

F06.29	Injection current of low frequency band	0.0-60.0 (100.0 is the rated current of the motor)	%	20.0 40.0-(F16.00=2)	●
F06.30	Regulator gain of low frequency band of injection current	0.00 - 10.00		0.50	●
F06.31	Regulator integral time of low frequency band of injection current	0.00 - 300.00	ms	10.00	●
F06.32	Frequency of high frequency band of injection current	0.00-100.00 (100.00 is the rated frequency of the motor)	%	20.00	●
F06.33	Injection current of high frequency band	0.0-30.0 (100.0 is the rated current of the motor)	%	8.0	●
F06.34	Regulator gain of high frequency band of injection current	0.00 - 10.00		0.50	●
F06.35	Regulator integral time of high frequency band of injection current	0.00 - 300.00	ms	10.00	●
F06.36	Magnetic	0.00~1.00		0.75	○

	saturation coefficient of synchronous motor				
F06.37	Stiffness coefficient of speed loop	0~20		12	●
F06.38	Gain coefficient of sliding mode of synchronous motor	1.00~3.70		3.50	○
F06.39	Error width of sliding mode of synchronous motor	0.005~0.100		0.100	○
F06.40	Amplitude of injected reactive current of synchronous motor	0.0~20.0	%	10.0	○
F06.41	Open-loop low-frequency processing of synchronous motor	0: VF 1: IF 2: IF in start and VF in stop		0	○
F06.42	Open-loop low-frequency processing range of synchronous motor	0.0 - 50.0	%	8.0	○
F06.43	IF injection current	0.0 - 600.0	%	50.0	○
F06.44	Time constant of pull-in current of magnetic	0.0 - 6000.0	ms	1.0	○

User Manual of EM730/EM730E Series Inverter

	pole				
F06.45	Initial lead angle of magnetic pole	0.0~359.9	°	30.0	○
F06.46	Speed tracking proportional gain of synchronous motor	0.00 - 10.00		1.00	○
F06.47	Speed tracking integral gain of synchronous motor	0.00 - 10.00		1.00	○
F06.48	Filtering time constant of speed tracking of synchronous motor	0.00 - 10.00	ms	0.40	○
F06.49	Speed tracking control intensity of synchronous motor	1.0 - 100.0		5.0	○
F06.50	Speed tracking control threshold of synchronous motor	0.00 - 10.00		0.20	○
F06.51	Rise time of injected active current of synchronous motor	0.010 - 1.000	s	0.020	○
F06.76	Low-speed correction	10.0~500.0	%	100.0	●

	factor of stator resistor of asynchronous motor															
F06.77	Low speed correction factor of rotor resistor of asynchronous motor	10.0~500.0								%	100.0	●				
F06.78	Slip gain switching frequency of asynchronous motor	0.10~Fmax								Hz	5.00	○				
F07	Protection function setting group															
F07.00	Protection shield	<table border="1"> <tr> <td>E20</td> <td>*</td> <td>E13</td> <td>E06</td> <td>*</td> <td>E04</td> <td>E07</td> <td>E08</td> </tr> </table> <p>0: valid protection 1: shielded protection</p>	E20	*	E13	E06	*	E04	E07	E08					0*0 0*000	○
E20	*	E13	E06	*	E04	E07	E08									
F07.01	Motor overload protection gain	0.20 - 10.00									1.00	●				
F07.02	Motor overload pre-alarm coefficient	50 - 100								%	80	●				
F07.06	Bus voltage control options	<p>Ones place: Instantaneous stop/no-stop function options</p> <p>0: Invalid 1: deceleration 2: deceleration to stop</p> <p>Tens place: Overvoltage stall function options</p> <p>0: Invalid 1: valid</p>									10	○				
F07.07	Voltage of overvoltage stall control	110.0 - 150.0 (380V, 100.0=537V)								%	131.0(703V)	○				
F07.08	Instantaneous stop/no-stop operating voltage	60.0 to instantaneous stop/no-stop recovery voltage (100.0 = standard bus voltage)								%	76.0	○				

User Manual of EM730/EM730E Series Inverter

F07.09	Instantaneous stop/no-stop recovery voltage	Instantaneous stop/no-stop operating voltage to 100.0						%	86.0	●	
F07.10	Check time for instantaneous stop/no-stop recovery voltage	0.00-100.00						s	0.50	●	
F07.11	Current limit control	0: Invalid 1: limit mode 1 2: limit mode 2							2	○	
F07.12	Current limit level	20.0-180.0(100.0 = the rated current of inverter)						%	150.0	●	
F07.13	Quick current limit options	0: Invalid 1: valid							0	○	
F07.14	Protection retries	0-20; 0: Disable protection retry							0	○	
F07.15	Options of digital output action in protection retries	0: no action 1: action							0	○	
F07.16	Interval of protection retries	0.01 - 30.00						s	0.50	●	
F07.17	Restoration time of protection retries	0.01 - 30.00						s	10.00	●	
F07.18	Action option of protection	E08	*	E07	*	E02	E06	E05	E04	0	○
		0: allow protection retry 1: disable protection retry								*0 *0000	
F07.19	Action option 1 of protection	E21	E16	E15	E14	E13	*	E08	E07	000	○
		0: free stop 1: stop according to stop mode								00*00	
F07.20	Action option 2 of protection	E28		E27	*	E23			00*0	○	
		0: free stop 1: stop according to stop mode									
F07.21	Options of load loss	0: Invalid 1: valid							0	●	

User Manual of EM730/EM730E Series Inverter

	protection												
F07.22	Load loss detection level	0.0-100.0	%	20.0	●								
F07.23	Load loss detection time	0.0 - 60.0	s	1.0	●								
F07.24	Options of load loss protection action	0: trip protection, free stop 1: trip protection, stop according to stop mode 2: Continue to run, with DO status output		1	○								
F07.25	Motor overspeed detection level	0.0-50.0 (reference: maximum frequency F00.16)	%	20.0	●								
F07.26	Motor overspeed detection time	0.0-60.0, 0.0: disable motor overspeed protection	s	1.0	●								
F07.27	AVR function	0: Invalid 1: valid 2: automatic		1	○								
F07.28	Stall protection detection time	0.0-6000.0(0.0: no stallprotection detection)	s	0.0	○								
F07.29	Stall control intensity	0 - 100	%	20	○								
F07.30	Instantaneous stop/no-stop deceleration time	0.00 - 300.00	s	20.00	○								
F07.32	Action option 2 of protection	<table border="1"> <tr> <td>E 13</td> <td>E 13</td> <td>E 15</td> <td>E 16</td> <td>*</td> <td>E 19</td> <td>E 20</td> <td>*</td> </tr> </table>	E 13	E 13	E 15	E 16	*	E 19	E 20	*		000 00000	○
		E 13	E 13	E 15	E 16	*	E 19	E 20	*				
0: allow protection retry 1: disable protection retry													
F07.34	Action option 3 of protection	<table border="1"> <tr> <td>*</td> <td>*</td> <td>*</td> <td>*</td> <td>*</td> <td>*</td> <td>E 09</td> <td>E 17</td> </tr> </table>	*	*	*	*	*	*	E 09	E 17		*****00	○
		*	*	*	*	*	*	E 09	E 17				
0: allow protection retry 1: disable protection retry													
F08 Multi-segment speed and simple PLC													
F08.00	Multi-segment speed 1	0.00 to maximum frequency F00.16	Hz	0.00	●								
F08.01	Multi-segment speed 2	0.00 to maximum frequency F00.16	Hz	5.00	●								

User Manual of EM730/EM730E Series Inverter

F08.02	Multi-segment speed 3	0.00 to maximum frequency F00.16	Hz	10.00	●
F08.03	Multi-segment speed 4	0.00 to maximum frequency F00.16	Hz	15.00	●
F08.04	Multi-segment speed 5	0.00 to maximum frequency F00.16	Hz	20.00	●
F08.05	Multi-segment speed 6	0.00 to maximum frequency F00.16	Hz	25.00	●
F08.06	Multi-segment speed 7	0.00 to maximum frequency F00.16	Hz	30.00	●
F08.07	Multi-segment speed 8	0.00 to maximum frequency F00.16	Hz	35.00	●
F08.08	Multi-segment speed 9	0.00 to maximum frequency F00.16	Hz	40.00	●
F08.09	Multi-speed 10	0.00 to maximum frequency F00.16	Hz	45.00	●
F08.10	Multi-segment speed 11	0.00 to maximum frequency F00.16	Hz	50.00	●
F08.11	Multi-segment speed 12	0.00 to maximum frequency F00.16	Hz	50.00	●
F08.12	Multi-segment speed 13	0.00 to maximum frequency F00.16	Hz	50.00	●
F08.13	Multi-segment speed 14	0.00 to maximum frequency F00.16	Hz	50.00	●
F08.14	Multi-segment speed 15	0.00 to maximum frequency F00.16	Hz	50.00	●
F08.15	Simple PLC running mode	0: stop after a single run 1: stop after a limited number of cycles 2: run at the last segment after a limited number of cycles 3: continuous cycles		0	●
F08.16	Limited number of cycles	1 - 10000		1	●
F08.17	Simple PLC memory options	Ones place: Stop memory options 0: no memory (from the first segment) 1: memory (from the moment of stop) Tens place: Power-down memory options 0: no memory (from the first segment) 1: Memory (from the power-down moment)		0	●
F08.18	Simple PLC time unit	0: s (second) 1: min (minute)		0	●
F08.19	Setting of the first segment	Ones place: Running direction options 0: forward		0	●

User Manual of EM730/EM730E Series Inverter

		1: reverse Tens place: Acceleration and deceleration time options 0: acceleration and deceleration time 1 1: acceleration and deceleration time 2 2: acceleration and deceleration time 3 3: acceleration and deceleration time 4			
F08.20	Running time of the first segment	0.0 - 6000.0	s/min	5.0	●
F08.21	Setting of the second segment	Ones place: Running direction options 0: forward 1: reverse Tens place: Acceleration and deceleration time options 0: acceleration and deceleration time 1 1: acceleration and deceleration time 2 2: acceleration and deceleration time 3 3: acceleration and deceleration time 4		0	●
F08.22	Running time of the second segment	0.0 - 6000.0	s/min	5.0	●
F08.23	Setting of the third segment	Ones place: Running direction options 0: forward 1: reverse Tens place: Acceleration and deceleration time options 0: acceleration and deceleration time 1 1: acceleration and deceleration time 2 2: acceleration and deceleration time 3 3: acceleration and deceleration time 4		0	●
F08.24	Running time of the third segment	0.0 - 6000.0	s/min	5.0	●
F08.25	Setting of the fourth segment	Ones place: Running direction options 0: forward 1: reverse Tens place: Acceleration and deceleration time options 0: acceleration and deceleration time 1 1: acceleration and deceleration time 2 2: acceleration and deceleration time 3 3: acceleration and deceleration time 4		0	●
F08.26	Running time of the fourth segment	0.0 - 6000.0	s/min	5.0	●
F08.27	Setting of the	Ones place: Running direction options		0	●

User Manual of EM730/EM730E Series Inverter

	fifth segment	0: forward 1: reverse Tens place: Acceleration and deceleration time options 0: acceleration and deceleration time 1 1: acceleration and deceleration time 2 2: acceleration and deceleration time 3 3: acceleration and deceleration time 4			
F08.28	Running time of the fifth segment	0.0 - 6000.0	s/min	5.0	●
F08.29	Setting of the sixth segment	Ones place: Running direction options 0: forward 1: reverse Tens place: Acceleration and deceleration time options 0: acceleration and deceleration time 1 1: acceleration and deceleration time 2 2: acceleration and deceleration time 3 3: acceleration and deceleration time 4		0	●
F08.30	Running time of the sixth segment	0.0 - 6000.0	s/min	5.0	●
F08.31	Setting of the seventh segment	Ones place: Running direction options 0: forward 1: reverse Tens place: Acceleration and deceleration time options 0: acceleration and deceleration time 1 1: acceleration and deceleration time 2 2: acceleration and deceleration time 3 3: acceleration and deceleration time 4		0	●
F08.32	Running time of the seventh segment	0.0 - 6000.0	s/min	5.0	●
F08.33	Setting of the eighth segment	Ones place: Running direction options 0: forward 1: reverse Tens place: Acceleration and deceleration time options 0: acceleration and deceleration time 1 1: acceleration and deceleration time 2 2: acceleration and deceleration time 3 3: acceleration and deceleration time 4		0	●
F08.34	Running time of the eighth	0.0 - 6000.0	s/min	5.0	●

User Manual of EM730/EM730E Series Inverter

	segment				
F08.35	Setting of the ninth segment	<p>Ones place: Running direction options</p> <p>0: forward</p> <p>1: reverse</p> <p>Tens place: Acceleration and deceleration time options</p> <p>0: acceleration and deceleration time 1</p> <p>1: acceleration and deceleration time 2</p> <p>2: acceleration and deceleration time 3</p> <p>3: acceleration and deceleration time 4</p>		0	•
F08.36	Running time of the ninth segment	0.0 - 6000.0	s/min	5.0	•
F08.37	Setting of the tenth segment	<p>Ones place: Running direction options</p> <p>0: forward</p> <p>1: reverse</p> <p>Tens place: Acceleration and deceleration time options</p> <p>0: acceleration and deceleration time 1</p> <p>1: acceleration and deceleration time 2</p> <p>2: acceleration and deceleration time 3</p> <p>3: acceleration and deceleration time 4</p>		0	•
F08.38	Running time of the tenth segment	0.0 - 6000.0	s/min	5.0	•
F08.39	Setting of the eleventh segment	<p>Ones place: Running direction options</p> <p>0: forward</p> <p>1: reverse</p> <p>Tens place: Acceleration and deceleration time options</p> <p>0: acceleration and deceleration time 1</p> <p>1: acceleration and deceleration time 2</p> <p>2: acceleration and deceleration time 3</p> <p>3: acceleration and deceleration time 4</p>		0	•
F08.40	Running time of the eleventh segment	0.0 - 6000.0	s/min	5.0	•
F08.41	Setting of the twelve segment	<p>Ones place: Running direction options</p> <p>0: forward</p> <p>1: reverse</p> <p>Tens place: Acceleration and deceleration time options</p> <p>0: acceleration and deceleration time 1</p> <p>1: acceleration and deceleration time 2</p> <p>2: acceleration and deceleration time 3</p> <p>3: acceleration and deceleration time 4</p>		0	•

User Manual of EM730/EM730E Series Inverter

F08.42	Running time of the twelfth segment	0.0 - 6000.0	s/min	5.0	●
F08.43	Setting of the thirteenth segment	Ones place: Running direction options 0: forward 1: reverse Tens place: Acceleration and deceleration time options 0: acceleration and deceleration time 1 1: acceleration and deceleration time 2 2: acceleration and deceleration time 3 3: acceleration and deceleration time 4		0	●
F08.44	Running time of the thirteenth segment	0.0 - 6000.0	s/min	5.0	●
F08.45	Setting of the fourteenth segment	Ones place: Running direction options 0: forward 1: reverse Tens place: Acceleration and deceleration time options 0: acceleration and deceleration time 1 1: acceleration and deceleration time 2 2: acceleration and deceleration time 3 3: acceleration and deceleration time 4		0	●
F08.46	Running time of the fourteenth segment	0.0 - 6000.0	s/min	5.0	●
F08.47	Setting of the fifteenth segment	Ones place: Running direction options 0: forward 1: reverse Tens place: Acceleration and deceleration time options 0: acceleration and deceleration time 1 1: acceleration and deceleration time 2 2: acceleration and deceleration time 3 3: acceleration and deceleration time 4		0	●
F08.48	Running time of the fifteenth segment	0.0 - 6000.0	s/min	5.0	●
F09	PID function group				
F09.00	PID setting source	0: digital PID setting 1: AI1 2: AI2		0	○

User Manual of EM730/EM730E Series Inverter

		3: Reserved 4: retention 5: PULSE, high-frequency pulse (X5) 6: Communication setting			
F09.01	Digital PID setting	0.0 to PID setting feedback range F09.03		0.0	●
F09.02	PID feedback source	1: AI1 2: AI2 3: Reserved 4: retention 5: PULSE, high-frequency pulse (X5) 6: Communication setting		1	○
F09.03	PID setting feedback range	0.1 - 6000.0		100.0	●
F09.04	PID positive and negative action selection	0: positive 1: negative		0	○
F09.05	Proportional gain 1	0.00-100.00		0.40	●
F09.06	Integral time 1	0.000 - 30.000, 0.000: no integral	s	2.000	●
F09.07	Differential time 1	0.000-30.000	ms	0.000	●
F09.08	Proportional gain 2	0.00-100.00		0.40	●
F09.09	Integral time 2	0.000 - 30.000, 0.000: no integral	s	2.000	●
F09.10	Differential time 2	0.000-30.000	ms	0.000	●
F09.11	PID parameter switching conditions	0: no switching 1: switching via digital input terminal 2: automatic switching according to deviation 3: Automatic switching by frequency		0	●
F09.12	PID parameter switching deviation 1	0.00 - F09.13	%	20.00	●
F09.13	PID parameter switching deviation 2	F09.12 - 100.00	%	80.00	●

User Manual of EM730/EM730E Series Inverter

F09.14	Initial PID value	0.00-100.00	%	0.00	●
F09.15	PID initial value holding time	0.00~650.00	s	0.00	●
F09.16	Upper limit of PID output	F9.17~+100.0	%	100.0	●
F09.17	Lower limit of PID output	-100.0~F9.16	%	0.0	●
F09.18	PID deviation limit	0.00-100.00 (0.00: invalid)	%	0.00	●
F09.19	PID differential limit	0.00-100.00	%	5.00	●
F09.20	PID integral separation threshold	0.00-100.00 (100.00% = invalid integral separation)	%	100.00	●
F09.21	PID setting change time	0.000-30.000	s	0.000	●
F09.22	PID feedback filtering time	0.000-30.000	s	0.000	●
F09.23	PID output filtering time	0.000-30.000	s	0.000	●
F09.24	Upper limit detection value of PID feedback disconnection	0.00-100.00; 100.00 = invalid feedback disconnection	%	100.00	●
F09.25	Lower limit detection value of PID feedback disconnection	0.00-100.00; 0.00 = invalid feedback disconnection	%	0.00	●
F09.26	Detection time of PID feedback disconnection	0.000-30.000	s	0.000	●
F09.27	PID sleep control	0: Invalid 1: sleep at zero speed		0	●

User Manual of EM730/EM730E Series Inverter

	options	2: sleep at lower frequency limit 3: sleep with tube sealed			
F09.28	Sleep action point	0.00-100.00 (100.00 corresponds to the PID setting feedback range)	%	100.00	●
F09.29	Sleep delay time	0.0 - 6500.0	s	0.0	●
F09.30	Wake-up action point	0.00-100.00 (100.00 corresponds to the PID setting feedback range)	%	0.00	●
F09.31	Wake-up delay time	0.0 - 6500.0	s	0.0	●
F09.32	Multi-segment PID setting 1	0.0 to PID setting feedback range F09.03		0.0	●
F09.33	Multi-segment PID setting 2	0.0 to PID setting feedback range F09.03		0.0	●
F09.34	Multi-segment PID setting 3	0.0 to PID setting feedback range F09.03		0.0	●
F09.35	Upper limit of feedback voltage	Lower limit of feedback voltage to 10.00	V	10.00	●
F09.36	Lower limit of feedback voltage	0.00 to upper limit of feedback voltage	V	0.00	●
F09.37	Integral action option within set PID change time	0: Always calculate the integral term 1: Calculate the integral term after the F09.21 set time is reached 2: Calculate the integral term when the error is less than F09.38		0 Straight-2	●
F09.38	Integral within set PID change time Input deviation	0.00-100.00	%	0	●
F09.39	Wake-up option	0: target pressure F09.01* coefficient of wake-up action point 1: Wake-up action point (F09.30)		0	○
F09.40	Coefficient of wake-up	0.0-100.0 (100% corresponds to PID setting)	%	90.0	●

User Manual of EM730/EM730E Series Inverter

	action point				
F09.41	Pipeline network alarm overpressure	0.0 to pressure sensor range F09.03	%	90.0	●
F09.42	Overpressure protection time	0-3600 (0: invalid)	bar	6	●
F09.43	PID reverse limit	0: no limit 1: limit		1	○
F10	Communication function group				
F10.00	Local Modbus communication address	1-247; 0: broadcast address		1	○
F10.01	Baud rate of Modbus communication	0:4800 1:9600 2:19200 3:38400 4:57600 5:115200		1	○
F10.02	Modbus data format	0: 1-8-N-1 (1 start bit + 8 data bits + 1 stop bit) 1: 1-8-E-1 (1 start bit + 8 data bits + 1 even parity check bit + 1 stop bit) 2: 1-8-O-1 (1 start bit + 8 data bits + 1 odd parity check bit + 1 stop bit) 3: 1-8-N-2 (1 start bit + 8 data bits + 2 stop bits) 4: 1-8-E-2 (1 start bit + 8 data bits + 1 even parity check bit + 2 stop bits) 5: 1-8-O-2 (1 start bit + 8 data bits + 1 odd parity check bit + 2 stop bits)		0	○
F10.03	485 communication timeout	0.0s-60.0s; 0.0: invalid (valid for the master-slave mode)	s	0.0	●
F10.04	Modbus response delay	1 - 20	ms	2	●
F10.05	Options of master-slave communication function	0: Invalid 1: valid		0	○
F10.06	Master-slave options	0: slave		0	○

User Manual of EM730/EM730E Series Inverter

		1: host (Modbus protocol broadcast transmission)			
F10.07	Data sent by host	0: output frequency 1: set frequency 2: output torque 3: set torque 4: PID setting 5: output current		1	○
F10.08	Proportional factor of slave reception	0.00-10.00 (multiple)		1.00	●
F10.09	Host sending interval	0.000-30.000	s	0.200	●
F10.10	Communication protocol option	0: Modbus-RTU protocol		0	×
F10.56	Options of 485 EEPROM writing	0-10: default operation (for commissioning) 11: writing not triggered (available after commissioning)		0	○
F10.57	Enabling of SCI sending timeout resetting	0: invalid resetting 1: valid resetting		1	●
F10.58	Delay time of SCI sending timeout resetting	110~10000	mS	150	●
F10.59	SCI response option	0: Reply to both read and write commands 1: Reply to write commands only 2: No reply to both read and write commands		0	○
F11	User-selected parameter group				
F11.00	User-selected parameter 1	The displayed content is Uxx.xx, which means that the Fxx.xx function code is selected. When the function code F11.00 is enabled, the keyboard displays U00.00, indicating that the first selected parameter is F00.00.		U00.00	●
F11.01	User-selected parameter 2			U00.01	●
F11.02	User-selected parameter 3			U00.02	●
F11.03	User-selected parameter 4			U00.03	●
F11.04	User-selected parameter 5			U00.04	●
F11.05	User-selected			U00.07	●

	parameter 6			
F11.06	User-selected parameter 7		U00.14	•
F11.07	User-selected parameter 8		U00.15	•
F11.08	User-selected parameter 9		U00.16	•
F11.09	User-selected parameter 10		U00.18	•
F11.10	User-selected parameter 11		U00.19	•
F11.11	User-selected parameter 12		U00.29	•
F11.12	User-selected parameter 13		U02.00	•
F11.13	User-selected parameter 14		U02.01	•
F11.14	User-selected parameter 15		U02.02	•
F11.15	User-selected parameter 16		U03.00	•
F11.16	User-selected parameter 17		U03.02	•
F11.17	User-selected parameter 18		U03.21	•
F11.18	User-selected parameter 19		U04.00	•
F11.19	User-selected parameter 20		U04.20	•
F11.20	User-selected parameter 21		U05.00	•
F11.21	User-selected parameter 22		U05.03	•
F11.22	User-selected parameter 23		U05.04	•
F11.23	User-selected parameter 24		U08.00	•
F11.24	User-selected parameter 25		U19.00	•
F11.25	User-selected parameter 26		U19.01	•
F11.26	User-selected parameter 27		U19.02	•

F11.27	User-selected parameter 28			U19.03	●
F11.28	User-selected parameter 29			U19.04	●
F11.29	User-selected parameter 30			U19.05	●
F11.30	User-selected parameter 31			U19.06	●
F11.31	User-selected parameter 32			U19.12	●
F12	Keyboard and display function group				
F12.00	M.K multi-function key options	0: no function 1: forward jog 2: reverse jog 3: forward/reverse switching 4: quick stop 5: free stop 6: Cursor left		1	○
F12.01	Options of stop function of STOP key	0: valid only in keyboard control 1: with all command channels valid		1	○
F12.02	Parameter locking	0: do not lock 1: reference input not locked 2: all locked, except for this function code		0	●
F12.03	Parameter copying	0: No operation 1: parameter upload to keyboard 2: Download parameters to inverter		0	○
F12.09	Load speed display coefficient	0.01~600.00		30.00	●
F12.10	UP/DOWN acceleration and deceleration rate	0.00: automatic rate 0.05~500.00Hz/s		5.00Hz/s	○
F12.11	Options of UP/DOWN offset clearing	0: Not clear (clear changes in main frequency setting) 1: clear in non-running state 2: Clear by releasing the UP/DOWN button		0	○
F12.12	Options of UP/DOWN power-down saving of offset	0: do not save 1: save (valid after the offset is modified)		1	○
F12.13	Power meter resetting	0: do not clear 1: clear		0	●

User Manual of EM730/EM730E Series Inverter

F12.14	Restoration of factory defaults	0: No operation 1: restoration of factory defaults (excluding the motor parameters, inverter parameters, manufacturer parameters, running and power-on time record)		0	○
F12.15	Cumulative power-on time (h)	0~65535	h	XXX	×
F12.16	Cumulative power-on time (min)	0 - 59	min	XXX	×
F12.17	Cumulative running time (h)	0~65535	h	XXX	×
F12.18	Cumulative running time (min)	0 - 59	min	XXX	×
F12.19	Rated power of inverter	0.40 - 650.00	kW	Depending on the motor type	×
F12.20	Rated voltage of inverter	60 - 690	V	Depending on the motor type	×
F12.21	Rated current of inverter	0.1 - 1500.0	A	Depending on the motor type	×
F12.22	Performance software S/N 1	XXX.XX		XXX.XX	×
F12.23	Performance software S/N2	XX.XXX		XX.XXX	×
F12.24	Functional software S/N 1	XXX.XX		XXX.XX	×
F12.25	Functional software S/N 2	XX.XXX		XX.XXX	×
F12.26	Keyboard software serial number 1	XXX.XX		XXX.XX	×
F12.27	Keyboard software serial number 2	XX.XXX		XX.XXX	×

F12.28	Serial No. 1	XX.XXX		XX.XXX	×
F12.29	Serial No. 2	XXXX.X		XXXX.X	×
F12.30	Serial No. 3	XXXXXX		XXXXXX	×
F12.31	LCD language options	0: Chinese 1: English 2: retention		0	●
F12.33	Running status display parameter 1 of Mode 1 (LED stop status display parameter 5)	0.00 - 99.99		18.00	●
F12.34	Running status display parameter 2 of Mode 1 (LED stop status display parameter 1)	0.00 - 99.99		18.01	●
F12.35	Running status display parameter 3 of Mode 1 (LED stop status display parameter 2)	0.00 - 99.99		18.06	●
F12.36	Running status display parameter 4 of Mode 1 (LED stop status display parameter 3)	0.00 - 99.99		18.08	●
F12.37	Running status display parameter 5	0.00 - 99.99		18.09	●

User Manual of EM730/EM730E Series Inverter

	of Mode 1 (LED stop status display parameter 4)							
F12.38	LCD large-line display parameter 1	0.00 - 99.99					18.00	●
F12.39	LCD large-line display parameter 2	0.00 - 99.99					18.06	●
F12.40	LCD large-line display parameter 3	0.00 - 99.99					18.09	●
F12.41	Options of UP/DOWN zero crossing	0: Invalid 1: valid					0	○
F12.42	Frequency setting of digital potentiometer	0.00 to maximum frequency F00.16				Hz	0.00	×
F12.43	Digital potentiometer torque setting	0.00- Digital torque setting F13.02				%	0.0	×
F12.45	UP/DOWN function options of keyboard	Communication	High-speed pulse	Analog quantity	Digital frequency	Multi-segment speed	00000	○
		0	0	0	0	0		
		0: Invalid 1: valid						
F13		Torque control parameter group						
F13.00	Speed/torque control options	0: Speed control 1: Torque control					0	○
F13.01	Options of	0: digital torque setting F13.02					0	○

	torque setting source	1: AI1 2: AI2 3: retention 4: retention 5: high frequency pulse input (X5) 6: Communication setting 7: retention 8: digital potentiometer setting (Full range of the items 1-6, corresponding to F13.02 digital torque setting)			
F13.02	Digital torque setting	-200.0 - 200.0	%	100.0	●
F13.03	Multi-segment torque 1	-200.0 - 200.0	%	0.0	●
F13.04	Multi-segment torque 2	-200.0 - 200.0	%	0.0	●
F13.05	Multi-segment torque 3	-200.0 - 200.0	%	0.0	●
F13.06	Torque control acceleration and deceleration time	0.00 - 120.00	s	0.00	●
F13.08	Upper frequency limit options of torque control	0: set by F13.09 1: AI1 2: AI2 3: retention 4: retention 5: high frequency pulse input (X5) 6: Communication setting (percentage) 7: Communication setting (direct frequency)		0	○
F13.09	Positive upper limit of torque control frequency	0.50 to maximum frequency F00.16	Hz	50.00	●
F13.10	Upper frequency limit offset	0.00 to maximum frequency F00.16	Hz	0.00	●
F13.11	Static friction torque compensatio	0.0-100.0	%	0.0	●

User Manual of EM730/EM730E Series Inverter

	n				
F13.12	Frequency range of static friction compensation	0.00 - 50.00	Hz	1.00	●
F13.13	Dynamic friction torque compensation	0.0-100.0	%	0.0	●
F13.18	Reverse speed limit options	0 - 100	%	100	●
F13.19	Reverse torque control options	0-1		0	●
F14	Parameter group of motor 2				
F14.00	Motor type	0: ordinary asynchronous motor 1: variable-frequency asynchronous motor 2: permanent magnet synchronous motor		0	○
F14.01	Rated power of electric motor	0.10~650.00	kW	Depending on the motor type	○
F14.02	Rated voltage of motor	50~2000	V	Depending on the motor type	○
F14.03	Rated current of motor	0.01 to 600.00 (rated power of motor: ≤ 75 kW) 0.1 to 6000.0 (rated power of motor: > 75 kW)	A	Depending on the motor type	○
F14.04	Rated frequency of motor	0.01~600.00	Hz	Depending on the motor type	○
F14.05	Rated speed	1~60000	rpm	Depending on the motor type	○
F14.06	Motor winding connection	0:Y 1:Δ		Depending on the motor type	○
F14.07	Rated power factor of motor	0.600~1.000		Depending on the motor type	○
F14.08	Motor efficiency	30.0~100.0	%	Depending on the motor type	○
F14.09	Stator resistance of asynchronous	1-60000 (rated power of motor: ≤ 75 kW) 0.1-6000.0 (rated power of motor: > 75kW)	mΩ	Depending on the motor type	○

User Manual of EM730/EM730E Series Inverter

	motor				
F14.10	Rotor resistance of asynchronous motor	1-60000 (rated power of motor: ≤ 75 kW) 0.1-6000.0 (rated power of motor: > 75 kW)	m Ω	Depending on the motor type	○
F14.11	Leakage inductance of asynchronous motor	0.01 to 600.00 (rated power of motor: ≤ 75 kW) 0.001 to 60.000 (rated power of motor: > 75 kW)	mH	Depending on the motor type	○
F14.12	Mutual inductance of asynchronous motor	0.1 to 6000.0 (rated power of motor: ≤ 75 kW) 0.01 to 600.00 (rated power of motor: > 75 kW)	mH	Depending on the motor type	○
F14.13	No-load excitation current of asynchronous motor	0.01 to 600.00 (rated power of motor: ≤ 75 kW) 0.1 to 6000.0 (rated power of motor: > 75 kW)	A	Depending on the motor type	○
F14.14	Flux weakening coefficient 1 of asynchronous motor	10.00 - 100.00	%	87.00	○
F14.15	Flux weakening coefficient 2 of asynchronous motor	10.00 - 100.00	%	80.00	○
F14.16	Flux weakening coefficient 3 of asynchronous motor	10.00 - 100.00	%	75.00	○
F14.17	Flux weakening coefficient 4 of asynchronous motor	10.00 - 100.00	%	72.00	○
F14.18	Flux weakening coefficient 5 of asynchronous motor	10.00 - 100.00	%	70.00	○
F14.19	Stator resistance of synchronous	1-60000 (rated power of motor: ≤ 75 kW) 0.1 to 6000.0 (rated power of motor: > 75 kW)	m Ω	Depending on the motor type	○

User Manual of EM730/EM730E Series Inverter

	motor				
F14.20	d-axis inductance of synchronous motor	0.01~600.00 (rated power of motor: ≤ 75 kW) 0.001~60.000 (rated power of motor: > 75kW)	mH	Depending on the motor type	○
F14.21	q-axis inductance of synchronous motor	0.01~600.00 (rated power of motor: ≤ 75 kW) 0.001~60.000 (rated power of motor: > 75kW)	mH	Depending on the motor type	○
F14.22	Counter electromotive force of synchronous motor	10.0-2000.0 (counter electromotive force of rated speed)	V	Depending on the motor type	○
F14.23	Initial electrical angle of synchronous motor	0.0-359.9 (valid for synchronous motor)			○
F14.34	Motor parameter self-learning	00: No operation 01: static self-learning of asynchronous motor 02: rotation self-learning of asynchronous motor 03: inertia self-learning of asynchronous motor 11: static self-learning of synchronous motor 12: rotary self-learning of synchronous motor 13: encoder self-learning of synchronous motor		00	○
F14.35	Drive control mode of motor 2	0: V/F control (VVF) 1: Speed sensorless vector control (SVC)		0	○
F14.36	Speed proportional gain ASR_P1	0.00-100.00		12.00	●
F14.37	Speed integral time constant ASR_T1	0.000-30.000 0.000: no integral	s	0.200	●
F14.38	Speed proportional gain ASR_P2	0.00-100.00		8.00	●
F14.39	Speed integral time constant ASR_T2	0.000-30.000 0.000: no integral	s	0.300	●
F14.40	Switching frequency 1	0.00 to switching frequency 2	Hz	5.00	●

User Manual of EM730/EM730E Series Inverter

F14.41	Switching frequency 2	Switching frequency 1 to maximum frequency F00.16	Hz	10.00	●
F14.42	No-load current gain of motor 2	50.0~300.0	%	50.0	●
F14.43	Filtering time constant of speed loop output	0.000 - 0.100	s	0.001	●
F14.44	Vector control slip gain	50.00-200.00	%	100.00	●
F14.45	Upper limit source selection of speed control torque	0: set by F06.10 and F06.11 1: AI1 2: AI2 3: retention 4: retention 5: Communication setting (percentage) 6: the larger of AI1 and AI2 7: The smaller of AI1 and AI2		0	○
F14.46	Upper limit of speed control motor torque	0.0 - 250.0	%	165.0	●
F14.47	Upper limit of speed control brake torque	0.0 - 250.0	%	165.0	●
F14.48	Excitation current proportional gain ACR-P1	0.00-100.00		0.50	●
F14.49	Excitation current integral time constant ACR-T1	0.00-600.00 0.00: no integral	ms	10.00	●
F14.50	Torque current proportional gain ACR-P2	0.00-100.00		0.50	●
F14.51	Torque current integral time constant ACR-T2	0.00-600.00 0.00: no integral	ms	10.00	●

User Manual of EM730/EM730E Series Inverter

F14.52	Stiffness coefficient of speed loop of motor 2	0~20		12	●
F14.53	SVC zero-frequency processing	0: braking 1: not processed 2: seal the tube		2	○
F14.54	SVC zero-frequency braking current	50.0-400.0 (100.0 is the no-load current of the motor)	%	100.0	○
F14.56	Voltage feedforward gain	0 - 100	%	0	●
F14.57	Flux weakening control options	0: Invalid 1: direct calculation 2: automatic adjustment		2	○
F14.58	Flux weakening voltage	70.00-100.00	%	95.00	●
F14.59	Maximum field weakening current of synchronous motor	0.0-150.0 (100.0 is the rated current of the motor)	%	100.0	●
F14.60	Proportional gain of flux weakening regulator	0.00 - 10.00		0.50	●
F14.61	Integral time of flux weakening regulator	0.01 - 60.00	s	2.00	●
F14.62	MTPA control option of synchronous motor	0: Invalid 1: valid		0	○
F14.63	Self-learning gain at initial position	0 - 200	%	100	●
F14.64	Frequency of low frequency band of	0.00-100.00 (100.00 is the rated frequency of the motor)	%	10.00	●

	injection current				
F14.65	Injection current of low frequency band	0.0-60.0 (100.0 is the rated current of the motor)	%	20.0	●
F14.66	Regulator gain of low frequency band of injection current	0.00 - 10.00		0.50	●
F14.67	Regulator integral time of low frequency band of injection current	0.00 - 300.00	ms	10.00	●
F14.68	Frequency of high frequency band of injection current	0.00-100.00 (100.00 is the rated frequency of the motor)	%	20.00	●
F14.69	Injection current f high frequency band	0.0-30.0 (100.0 is the rated current of the motor)	%	8.0	●
F14.70	Regulator gain of high frequency band of injection current	0.00 - 10.00		0.50	●
F14.71	Regulator integral time of high frequency band of injection current	0.00 - 300.00	ms	10.00	●
F14.77	Acceleration/ deceleration time options of motor 2	0: the same as motor 1 1: acceleration and deceleration time 1 2: acceleration and deceleration time 2 3: acceleration and deceleration time 3 4: acceleration and deceleration time 4		0	○

User Manual of EM730/EM730E Series Inverter

F14.78	Maximum frequency of motor 2	20.00~600.00	Hz	50	○
F14.79	Upper frequency limit of motor 2	Lower limit frequency F00.19 to maximum frequency F14.78	Hz	50	●
F14.80	V/F curve setting of motor 2	0: straight line V/F 1: multi-point broken line V/F 2: 1.3-power V/F 3: 1.7-power V/F 4: square V/F 5: VF complete separation mode (Ud = 0, Uq = K * t = voltage of separation voltage source) 6: VF semi-separation mode (Ud = 0, Uq = K * t = F/Fe * 2 * voltage of separation voltage source)		0	○
F14.81	Multi-point VF frequency F1 of motor 2	0.00 - F14.83	Hz	0.50	●
F14.82	Multi-point VF voltage V1 of motor 2	0.0~100.0 (100.0 = Rated voltage)	%	1.0	●
F14.83	Multi-point VF frequency F2 of motor 2	F14.81 - F14.85	Hz	2.00	●
F14.84	Multi-point VF voltage V2 of motor 2	0.0-100.0	%	4.0	●
F14.85	Multi-point VF frequency F3 of motor 2	F14.83 to rated frequency of motor (reference frequency)	Hz	5.00	●
F14.86	Multi-point VF voltage V3 of motor 2	0.0-100.0	%	10.0	●
F14.87	Stop mode of motor 2	0: Slow down to stop 1: free stop		0	○
F14.96	Low speed correction factor of stator resistor of asynchronous motor 2	10.0~500.0	%	100.0	●
F14.97	Low speed	10.0~500.0	%	100.0	●

User Manual of EM730/EM730E Series Inverter

	correction factor of rotor resistor of asynchronous motor 2				
F14.98	Slip gain switching frequency of asynchronous motor 2	0.10~Fmax	Hz	5.00	○
F15	Auxiliary function group				
F15.00	Jog frequency	0.00 to maximum frequency F00.16		Hz	5.00
F15.01	Jog acceleration time	0.00 - 650.00 (F15.13=0) 6500.0 (F15.13=1) (F15.13=2)	0.0 - 0 - 65000 s	5.00	●
F15.02	Jog deceleration time	0.00 - 650.00 (F15.13=0) 6500.0 (F15.13=1) (F15.13=2)	0.0 - 0 - 65000 s	5.00	●
F15.03	Acceleration time 2	0.00 - 650.00 (F15.13=0) 6500.0 (F15.13=1) (F15.13=2)	0.0 - 0 - 65000 s	15.00	●
F15.04	Deceleration time 2	0.00 - 650.00 (F15.13=0) 6500.0 (F15.13=1) (F15.13=2)	0.0 - 0 - 65000 s	15.00	●
F15.05	Acceleration time 3	0.00 - 650.00 (F15.13=0) 6500.0 (F15.13=1) (F15.13=2)	0.0 - 0 - 65000 s	15.00	●
F15.06	Deceleration time 3	0.00 - 650.00 (F15.13=0) 6500.0 (F15.13=1) (F15.13=2)	0.0 - 0 - 65000 s	15.00	●
F15.07	Acceleration time 4	0.00 - 650.00 (F15.13=0) 6500.0 (F15.13=1) (F15.13=2)	0.0 - 0 - 65000 s	15.00	●
F15.08	Deceleration time 4	0.00 - 650.00 (F15.13=0) 6500.0 (F15.13=1) (F15.13=2)	0.0 - 0 - 65000 s	15.00	●
F15.09	Fundamental frequency of acceleration and deceleration time	0: maximum frequency F00.16 1: 50.00Hz 2: set frequency		0	○
F15.10	Automatic	0: Invalid		0	○

	switching of acceleration and deceleration time	1: valid			
F15.11	Switching frequency of acceleration time 1 and 2	0.00 to maximum frequency F00.16	Hz	0.00	●
F15.12	Switching frequency of deceleration time 1 and 2	0.00 to maximum frequency F00.16	Hz	0.00	●
F15.13	Acceleration and deceleration time unit	0:0.01s 1:0.1s 2:1s		0	○
F15.14	Frequency hopping point 1	0.00-600.00	Hz	600.00	●
F15.15	Hopping range 1	0.00-20.00, 0.00 is invalid	Hz	0.00	●
F15.16	Frequency hopping point 2	0.00-600.00	Hz	600.00	●
F15.17	Hopping range 2	0.00-20.00, 0.00 is invalid	Hz	0.00	●
F15.18	Frequency hopping point 3	0.00-600.00	Hz	600.00	●
F15.19	Hopping range 3	0.00-20.00, 0.00 is invalid	Hz	0.00	●
F15.20	Detection width of output frequency arrival (FAR)	0.00 - 50.00	Hz	2.50	○
F15.21	Output frequency detection FDT1	0.00 to maximum frequency F00.16	Hz	30.00	○
F15.22	FDT1 hysteresis	-(Fmax-F15.21)~F15.21	Hz	2.00	○

User Manual of EM730/EM730E Series Inverter

F15.23	Output frequency detection FDT2	0.00 to maximum frequency F00.16	Hz	20.00	○
F15.24	FDT2 hysteresis	-(Fmax-F15.23)~F15.23	Hz	2.00	○
F15.25	Options of analog level detection ADT	0: AI1 1: AI2		0	○
F15.26	Analog level detection ADT1	0.00-100.00	%	20.00	●
F15.27	ADT1 hysteresis	0.00 to F15.26 (valid down in one direction)	%	5.00	●
F15.28	Analog level detection ADT2	0.00-100.00	%	50.00	●
F15.29	ADT2 hysteresis	0.00 to F15.28 (valid down in one direction)	%	5.00	●
F15.30	Options of energy consumption braking function	0: Invalid 1: valid		0	○
F15.31	Energy consumption braking voltage	110.0-140.0 (380V, 100.0 = 537V)	%	125.0	○
F15.32	Braking rate	20-100 (100 means that duty ratio is 1)	%	100	●
F15.33	Operating mode with set frequency less than lower frequency limit	0: running at the lower frequency limit 1: Shutdown 2: zero-speed running		0	○
F15.34	Fan control	0: running after power-on 1: running at startup 2: intelligent operation, subject to temperature control		1	○
F15.35	Overmodulation intensity	1.00 - 1.10		1.05	●
F15.36	Switching	0: invalid (7-segment PWM modulation)		0	○

User Manual of EM730/EM730E Series Inverter

	options of PWM modulation mode	1: valid (5-segment PWM modulation)			
F15.37	Switching frequency of PWM modulation mode	0.00 to maximum frequency F00.16	Hz	15.00	●
F15.38	Options of dead zone compensation mode	0: no compensation 1: compensation mode 1 2: compensation mode 2		1	○
F15.39	Terminal jog priority	0: Invalid 1: valid		0	○
F15.40	Deceleration time for quick stop	0.00 - 650.00 (F15.13=0) 6500.0 (F15.13=1) (F15.13=2)	0.0 - 0 - 65000 s	1.00	●
F15.66	Overcurrent detection level	0.1-300.0 (0.0: no detection; 100.0%: corresponding to the rated current of motor)	%	200.0	●
F15.67	Overcurrent detection delay time	0.00-600.00	s	0.00	●
F15.68	Market price	0.00-100.00		1.00	○
F15.69	Power-frequency load factor	30.0-200.0	%	90.0	○
F16	Customization function group				
F16.00	Industry application	0: Universal model 1: Water supply application 2: Air compressor application 3: Winding application 4: fan application 5: Spindle application of machine tool 6: Extruder application 7: High-speed motor application		0	○
F16.01	Set length	1 - 65535 (F16.13=0) 0.1 - 6553.5 (F16.13=1) 0.01 - 655.35 (F16.13=2) 0.001 - 65.535 (F16.13=3)	m	1000	●

User Manual of EM730/EM730E Series Inverter

F16.02	Pulses per meter	0.1 - 6553.5		100.0	●
F16.03	Set count value	F16.04 - 65535		1000	●
F16.04	Specified count value	1 - F16.03		1000	●
F16.05	Set time of regular running	0.0-6500.0, 0.0 is invalid	min	0.0	●
F16.06	Agent password	0~65535		0	●
F16.07	Setting of cumulative power-on arrival time	0-65535; 0: disable the protection when the power-on time is up	h	0	●
F16.08	Setting of cumulative running arrival time	0-65535; 0: disable the protection when the running time is up	h	0	●
F16.09	Factory password	0~65535		XXXX	●
F16.10	Analog output percentage corresponding to the count value 0	0.00-100.00	%	0.00	○
F16.11	Analog output percentage corresponding to the set count value	0.00-100.00	%	100.00	○
F16.13	Set length resolution	0:1m 1:0.1m 2:0.01 m 3:0.001m		0	○
F17	Virtual I/O function group				
F17.00	VX1 virtual input function	The same as the function options of digital input terminal of F02 group		0	○

	options												
F17.01	VX2 virtual input function options											0	○
F17.02	VX3 virtual input function options											0	○
F17.03	VX4 virtual input function options											0	○
F17.04	VX5 virtual input function options											0	○
F17.05	VX6 virtual input function options											0	○
F17.06	VX7 virtual input function options											0	○
F17.07	VX8 virtual input function options											0	○
F17.08	Virtual input positive/negative logic	D7	D6	D5	D4	D3	D2	D1	D0		0: positive logic, valid in the closed state/invalid in the open state 1: Negative logic, invalid in the closed state/valid in the open state	000 00000	○
		VX8	VX7	VX6	VX5	VX4	VX3	VX2	VX1				
F17.09	VX1-VX8 status setting options	D7	D6	D5	D4	D3	D2	D1	D0		0: the VXn status is the same as VYn output status 1: status set by F17.10	000 00000	○
		VX8	VX7	VX6	VX5	VX4	VX3	VX2	VX1				
F17.10	VX1-VX8 status setting	D7	D6	D5	D4	D3	D2	D1	D0		0: Invalid 1: valid	000 00000	●
		VX8	VX7	VX6	VX5	VX4	VX3	VX2	VX1				

User Manual of EM730/EM730E Series Inverter

F17.11	VX1 valid delay time	0.000-30.000								s	0.000	●
F17.12	VX1 invalid delay time	0.000-30.000								s	0.000	●
F17.13	VX2 valid delay time	0.000-30.000								s	0.000	●
F17.14	VX2 invalid delay time	0.000-30.000								s	0.000	●
F17.15	VX3 valid delay time	0.000-30.000								s	0.000	●
F17.16	VX3 invalid delay time	0.000-30.000								s	0.000	●
F17.17	VX4 valid delay time	0.000-30.000								s	0.000	●
F17.18	VX4 invalid delay time	0.000-30.000								s	0.000	●
F17.19	VY1 virtual output function options	The same as the function options of digital output terminal of F03 group									0	○
F17.20	VY2 virtual output function options										0	○
F17.21	VY3 virtual output function options										0	○
F17.22	VY4 virtual output function options										0	○
F17.23	VY5 virtual output function options										0	○
F17.24	Reserved											
F17.25	Reserved											
F17.26	Reserved											
F17.27	Virtual output	D7	D6	D5	D4	D3	D2	D1	D0		00000	○
		VY8	VY7	VY6	VY5	VY4	VY3	VY2	VY1			

User Manual of EM730/EM730E Series Inverter

	positive/negative logic	0: positive logic, valid in the closed state/invalid in the open state 1: Negative logic, invalid in the closed state/valid in the open state										
F17.28	Control options of virtual output terminal	D7	D6	D5	D4	D3	D2	D1	D0		11111	○
		VY8	VY7	VY6	VY5	VY4	VY3	VY2	VY1			
		0: Depending on the status of terminal X1-X5 (without VY6-8) 1: depending on the output function status										
F17.29	VY1 valid delay time	0.000-30.000								s	0.000	●
F17.30	VY1 invalid delay time	0.000-30.000								s	0.000	●
F17.31	VY2 valid delay time	0.000-30.000								s	0.000	●
F17.32	VY2 invalid delay time	0.000-30.000								s	0.000	●
F17.33	VY3 valid delay time	0.000-30.000								s	0.000	●
F17.34	VY3 invalid delay time	0.000-30.000								s	0.000	●
F17.35	VY4 valid delay time	0.000-30.000								s	0.000	●
F17.36	VY4 invalid delay time	0.000-30.000								s	0.000	●
F17.37	Virtual input terminal status	VX8	VX7	VX6	VX5	VX4	VX3	VX2	VX1		000 00000	×
		0: Invalid 1: valid										
F17.38	Virtual output terminal status	VY8	VY7	VY6	VY5	VY4	VY3	VY2	VY1		00000	×
		0: Invalid 1: valid										
F18 Monitoring parameter group												
F18.00	Output frequency	0.00 to upper frequency limit								Hz	XXX	×
F18.01	Set frequency	0.00 to maximum frequency F00.16								Hz	XXX	×
F18.03	Estimate feedback frequency	0.00 to upper frequency limit								Hz	XXX	×
F18.04	Output torque	-200.0 - 200.0								%	XXX	×

User Manual of EM730/EM730E Series Inverter

F18.05	Torque setting	-200.0 - 200.0					%	XXX	×
F18.06	Output current	0.00 to 650.00 (rated power of motor: ≤ 75 kW) 0.0 to 6500.0 (rated power of motor: > 75 kW)					A	XXX	×
F18.07	Output current percentage	0.0-300.0 (100.0 = the rated current of inverter)					%	0	×
F18.08	Output voltage	0.0 - 690.0					V	XXX	×
F18.09	DC bus voltage	0 - 1200					V	XXX	×
F18.10	Simple PLC running times	0 - 10000						XXX	×
F18.11	Simple PLC operation stage	1 - 15						XXX	×
F18.12	PLC running time at the current stage	0.0 - 6000.0						XXX	×
F18.14	Load rate	0~65535					rpm	XXX	×
F18.15	UP/DOWN offset frequency	0.00 to 2 * Maximum frequency F00.16					Hz	XXX	×
F18.16	PID setting	0.0 to PID maximum range						XXX	×
F18.17	PID feedback	0.0 to PID maximum range						XXX	×
F18.18	Power meter: MWh	0~65535					MWh	XXX	×
F18.19	Watt-hour meter: kWh	0.0 - 999.9					kWh	XXX	×
F18.20	Output power	-650.00~650.00					kW	XXX	×
F18.21	Output power factor	-1.000 - 1.000						XXX	×
F18.22	Digital input terminal status 1	X5	X4	X3	X2	X1		XXX	×
		0/1	0/1	0/1	0/1	0/1			
F18.23	Digital input terminal status 2	*	AI2	AI1	*	*		XXX	×
		*	0/1	0/1	*	0/1			
F18.25	Output terminal	*	*	R1	*	Y1		XXX	×
		*	*	0/1	*	0/1			

User Manual of EM730/EM730E Series Inverter

	state							
F18.26	AI1	0.0-100.0				%	XXX	×
F18.27	AI2	0.0-100.0				%	XXX	×
F18.31	High-frequency pulse input frequency: kHz	0.00-100.00				kHz	XXX	×
F18.32	High-frequency pulse input frequency: Hz	0~65535				Hz	XXX	×
F18.33	Count value	0~65535					XXX	×
F18.34	Actual length	0~65535				m	XXX	×
F18.35	Remaining time of regular running	0.0 - 6500.0				min	XXX	×
F18.36	Rotor position of synchronous motor	0.0~359.9°					XXX	×
F18.39	VF separation target voltage	0 - 690				V	XXX	×
F18.40	VF separation output voltage	0 - 690				V	XXX	×
F18.51	PID output	-100.0 - 100.0				%		×
F18.60	Inverter temperature	-40 to 200				°C	0	×
F18.67	Saved electric energy (MWH)	Cumulative energy saving MWH				0~65535	MWh	×
F18.68	Saved electric energy (KWH)	Cumulative energy saving KWH				0.0~999.9	kWh	×

User Manual of EM730/EM730E Series Inverter

F18.69	Saved electric charge (1,000 yuan)	High cumulative cost saving (*1000)	0~65535		×
F18.70	Saved electric charge (yuan)	Low cumulative cost saving	0.0~999.9		×
F18.71	Power-frequency power consumption MWh	Power-frequency power consumption MWh	0~65535	MWh	×
F18.72	Power-frequency power consumption KWh	Power-frequency power consumption KWh	0.0~999.9	kWh	×
F19 Protection record group					
F19.00	Category of last protection	0: No protection E01: output short circuit protection E02: instantaneous overcurrent E04: steady-state overcurrent E05: Overvoltage E06: Undervoltage E07: input phase loss E08: output phase loss E09: inverter overload E10: inverter overheat protection E11: Parameter setting conflict E13: motor overload E14: External protection E15: inverter memory protection E16: communication abnormality E17: Temperature sensor abnormality E18: Abnormal disconnection of soft start relay E19: current detection circuit abnormality E20: Stall protection E21: PID feedback disconnection E22: retention E24: parameter identification abnormality E25: retention E26: Load loss protection E27: up to the cumulative power-on time E28: up to the cumulative running time		0	×

User Manual of EM730/EM730E Series Inverter

		E43: Material cutoff protection E44: Cable protection E57: Overpressure in pipeline network E58: Under-pressure in pipeline network E76: Short-circuit protection to ground			
F19.01	Output frequency in protection	0.00 to upper frequency limit	Hz	0.00	×
F19.02	Output current in protection	0.00 to 650.00 (rated power of motor: ≤ 75 kW) 0.0 to 6500.0 (rated power of motor: > 75 kW)	A	0.00	×
F19.03	Bus voltage in protection	0 - 1200	V	0	×
F19.04	Operating status in protection	0: not running 1: forward acceleration 2: reverse acceleration 3: forward deceleration 4: reverse deceleration 5: constant speed in forward running 6: reverse constant speed in reverse running		0	×
F19.05	Working time in protection		h	0	×
F19.06	Category of previous protection	Same as F19.00 parameter description		0	×
F19.07	Output frequency in protection		Hz	0.00	×
F19.08	Output current in protection		A	0.00	×
F19.09	Bus voltage in protection		V	0	×
F19.10	Operating status in protection	Same as F19.04 parameter description		0	×
F19.11	Working time in protection		h	0	×
F19.12	Category of two previous protections	Same as F19.00 parameter description		0	×

User Manual of EM730/EM730E Series Inverter

F19.13	Output frequency in protection		Hz	0.00	×
F19.14	Output current in protection		A	0.00	×
F19.15	Bus voltage in protection		V	0	×
F19.16	Operating status in protection	Same as F19.04 parameter description		0	×
F19.17	Working time in protection		h	0	×
F27	Winding/unwinding application macro parameter group				
F27.00	Application macro	0: Winding mode 1: Unwinding mode 2: Wire drawing mode 3: Straight wire drawing machine mode		0	○
F27.01	Feedforward gain action channel	0: feedforward gain * set source B 1: Feedforward gain * set source A 2: Feedforward gain * 10V		1	○
F27.02	Feedforward gain input mode	0: No change in feedforward gain 1: 0.00 to upper limit of feedforward gain 2: - upper limit of feedforward gain to + upper limit of feedforward gain		1	○
F27.03	Feedforward control	Ones place: Feedforward reset option 0: Automatic reset 1: Terminal reset Tens place: Feedforward power-off stop option 0: Save after power failure 1: Not save after power failure Hundreds place: Options of continuous feedforward calculation 0: Not calculate 1: Calculate		10	○
F27.04	Upper limit of feedforward gain	0.00~500.00	%	500.00	○
F27.05	Initial feedforward gain	0.00~500.00	%	50.00	●

User Manual of EM730/EM730E Series Inverter

F27.06	Feedforward gain filter time	0~1000	ms	0	●
F27.07	Feedforward range 0	0.00 to feedforward range 1	%	4.00	●
F27.08	Feedforward range 1	Feedforward range 0 to feedforward range 2	%	12.00	●
F27.09	Feedforward range 2	Feedforward range 1 to feedforward range 3	%	23.00	●
F27.10	Feedforward range 3	Feedforward range 2 to feedforward range 4	%	37.00	●
F27.11	Feedforward range 4	Feedforward range 3 to feedforward range 5	%	52.00	●
F27.12	Feedforward range 5	Feedforward range 4 to 100.00	%	72.00	●
F27.13	Soft start increment	0.00 - 50.00	%/S	0.60	●
F27.14	Feedforward increment 1	0.00 - 50.00	%/S	0.11	●
F27.15	Feedforward increment 2	0.00 - 50.00	%/S	0.30	●
F27.16	Feedforward increment 3	0.00 - 50.00	%/S	0.75	●
F27.17	Feedforward increment 4	0.00 - 50.00	%/S	1.55	●
F27.18	Feedforward increment 5	0.00 - 50.00	%/S	4.00	●
F27.19	Feedforward increment 6	0.00 - 50.00	%/S	11.00	●
F27.20	Material cutoff control mode	<p>Ones place: Disconnection detection mode 0: Automatic detection 1: External signal</p> <p>Tens place: Material cutoff detection control 0: Detect when the output is greater than the lower limit of material cutoff detection 1: no detection</p> <p>Hundreds place: Material cutoff handling mode 0: Protection of terminal action only 1: Delayed stop and trip protection 2: Material cutoff protection 3: Automatic reset after protection shutdown 4: Material cutoff detection terminal output only (straight wire drawing machine) 5: Automatic reset of cutoff</p>		01201	○

User Manual of EM730/EM730E Series Inverter

		detection terminal (straight wire drawing machine) Thousands place: Brake mode 0: mode 0 1: mode 1 Myriabit: Reverse unwinding mode 0: No speed limit 1: Reverse speed limit by F27.24			
F27.21	Material cutoff detection delay	0.0~10.0	S	6.0	•
F27.22	Lower limit of material cutoff detection after parking	0.00 - 60.00	Hz	5.00	•
F27.23	Time of continuous running after material cutoff	0.0 - 60.0	S	10.0	•
F27.24	Frequency of continuous running after material cutoff	0.00~Fmax	Hz	5.00	•
F27.25	Brake signal output frequency	0.00~FUP	Hz	2.50	•
F27.26	Braking signal duration	0.0-100.0	S	5.0	•
F27.27	Minimum frequency of wiring detection	0.00~20.00	Hz	10.00	•
F27.28	Judgment time for invalid cable signal	0.1 - 20.0	S	10.0	•
F27.29	Judgment time for valid cable	0.1 - 20.0	S	2.0	•

User Manual of EM730/EM730E Series Inverter

	signal				
F27.30	Filtering time for material cutoff detection	1~100	ms	5	•
F27.36	Current value of feedforward gain	-500.0~500.0	%		×

Chapter 7 Function Code Details

7.1 Basic Function Parameter Group of F00 Group

Function code	Function code name	Parameter description	Unit	Default setting	Attribute
F00.01	Drive control mode of motor 1	0: V/F control (VVF) 1: Speed sensorless vector control (SVC)		0	○

F00.01=0: V/F control (VVF)

It is used for one-to-many, fast and low-precision speed control.

F00.01=1: speed sensorless vector control (SVC)



The open-loop vector control is suitable for general high-performance control. An inverter drives one motor only. It is suitable for machine tools, centrifuges, drawing machines, injection molding machines and other loads.



1. In order to improve the control performance, self-learning is needed to obtain the correct motor parameters before vector control.
2. In the vector control mode, the inverter can be used with one motor only, and the motor capacity should not be greatly different from the inverter capacity; otherwise, the control performance may decline or the system may not work properly.

Function code	Function code name	Parameter description	Unit	Default setting	Attribute
F00.02	Options of command source	F00.02=0: keyboard control (LOC/REM indicator ON) 1: terminal control (LOC/REM indicator: OFF) 2: communication control (LOC/REM indicator: flicker)		0	○

F00.02=0: keyboard control (LOC/REM indicator ON)

The start and stop of the inverter are controlled by the RUN key , STOP key  on the keyboard. In the case of no trip protection, press the RUN key  to enter the

running status. If the green LED indicator above the RUN key  is ON, it indicates that the inverter is in the running status. If this indicator is flickering, it means that the inverter is in the status of deceleration to stop.

Regardless of the speed or torque reference input control, the inverter will run in the input control mode at the jog speed once jogging is enabled.

F00.02=1: terminal control (LOC/REM indicator OFF)

The start and stop of the inverter are controlled by the start and stop control terminals that are defined by the function codes F02.00 to F02.06. Detailed settings of terminal control are dependent on F00.03.

F00.02=2: Communication control (LOC/REM indicator flickering)

The inverter start and stop are controlled by the host through the RS485 communication port. See the 11.3.4Register **address distribution** 7000H control description for details.

	<p>The final command source also depends on the input functions “24: switching from the Run command to keyboard” and “25: switching from the Run command to communication”. If the input function “24: switching from the Run command to keyboard” is valid, the current command source is “keyboard control”. If the input function “25: switching from the Run command to communication” is valid, the current command source is “communication control”. Otherwise, the command source depends on the setting of the function code F00.02.</p>
---	---

Function code	Function code name	Parameter description	Unit	Default setting	Attribute
F00.03	Options of terminal control mode	0: terminal RUN (running) and F/R (forward/reverse) 1: terminal RUN (forward) and F/R (reverse) 2: terminal RUN (forward), Xi (stop) and F/R (reverse) 3: terminal RUN (running), Xi (stop) and F/R (forward/reverse)		0	○

Terminal RUN: Xi terminal is set to “1: terminal RUN”

Terminal F/R: Xi terminal is set to “2: running direction F/R”

Terminal control can be divided into two types: two-line control and three-line control.

Two-line control:

F00.03=0: the terminal RUN is in the running status, and F/R in the forward/reverse status.

Enable/Disable the terminal RUN to control the start and stop of the inverter, and the terminal F/R to control the forward/reverse running. If F00.21 is set to 1 and reverse running is disabled, the F/R terminal will not be available. If the mode of deceleration to stop is selected, the logic diagram is as shown in Fig. 7-6(b);

F00.03=1: the terminal RUN controls forward running, and the terminal F/R is in the reverse mode.

Enable/Disable the terminal RUN to control the forward running and stop of the inverter, and the terminal F/R to control the reverse running and stop. When the terminals RUN and F/R are enabled simultaneously, the inverter will be stopped. If reverse running is disabled, the terminal F/R will not be available. If the mode of deceleration to stop is selected, the forward/reverse logic will be run, as shown in Fig. 7-6(d);

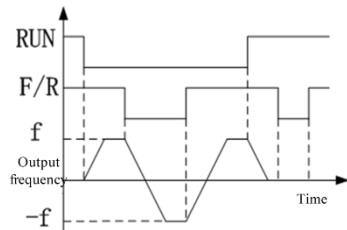
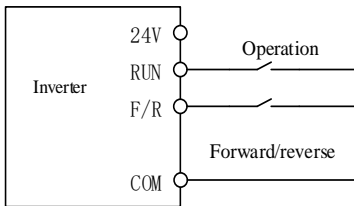

(a) Wiring diagram of two-line control (F00.03=0) (b) F04.19=0, F00.03=0, run the forward/reverse logic

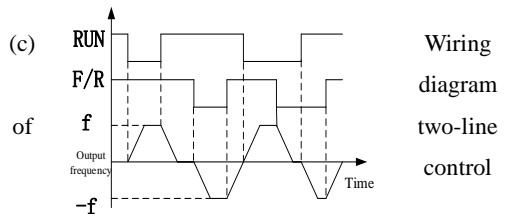
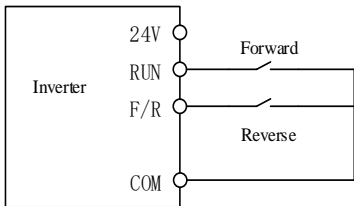

(c) Wiring diagram of two-line control (F00.03=1) (d) F04.19=0, F00.03=1: forward/reverse running logic

Fig. 7-6 Two-line Control

When the start/stop value of F00.03 is set to 0 or 1, even if the terminal RUN is available, the inverter can be stopped by pressing the STOP key  or sending an external stop command to the terminal. In this case, the inverter will not be in the

running status until the terminal RUN is disabled and then enabled.

Three-line control:

F00.03=2: the terminal RUN controls forward running, the terminal Xi is for stop, and the terminal F/R is in the reverse status.

The terminal RUN is normally ON for forward running, and the terminal F/R is normally ON for reverse running, with valid pulse edges. The terminal Xi is normally closed for stop, with the valid level. When the inverter is in the running status, press Xi to stop it. When the mode of deceleration to stop (F04.19=0) is selected, the logic diagram is as shown in Fig. 7-7(b). The terminal Xi is for “three-line running and stop control” as defined by F02.00 to F02.04.

F00.03=3: the terminal RUN is for running, Xi for stop and F/R for forward/reverse control.

The terminal RUN is normally ON for running, with the valid pulse edge, F/R for forward/reverse switching (forward in the OFF status and reverse in the ON status), and Xi is normally OFF for stop, with the valid level. When the mode of deceleration to stop (F04.19=0) is selected, the logic diagram is as shown in Fig. 7-7(d).

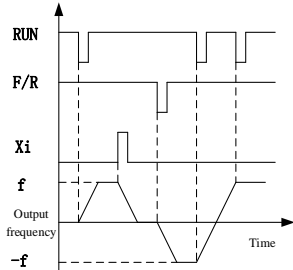
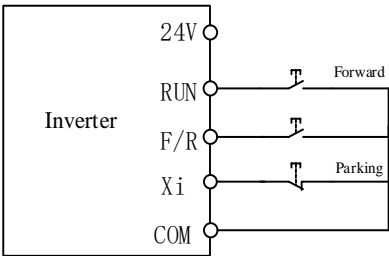

(a) Wiring diagram of three-line control (F00.03=2) (b) F04.19=0, F00.03=2: forward/reverse running logic

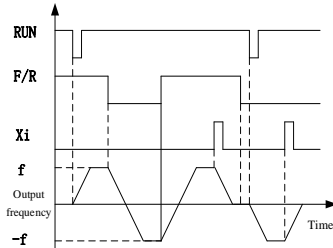
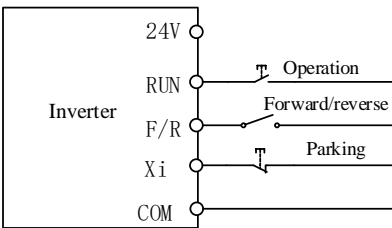

(c) Wiring diagram of three-line control (F00.03=3) (d) F04.19=0, F00.03=3:
forward/reverse running logic

Fig. 7-7 Three-line Control

 The three-line control logic of the EM730/EM730E series inverter is consistent with the conventional electrical control. The keys and knob switches should be used correctly as shown in the schematic diagram. Otherwise, operation errors may be caused.

Function code	Function code name	Parameter description	Unit	Default setting	Attribute
F00.04	Options of main frequency source A	0: digital frequency setting F00.07 1: AI1 2: AI2 3: retention 4: retention 5: high frequency pulse input (X5) 6: Percentage setting of main frequency communication 7: Direct setting of main frequency communication 8: digital potentiometer setting		8	○

F00.04=0: digital frequency setting F00.07

The main frequency source A depends on the digital frequency setting F00.07.

F00.04=1:AI1

F00.04=2:AI2

The main frequency source A depends on the AI (percentage) * F00.16.

AI1 is the 0-10V voltage input;

AI2 is the 0-10V voltage input or 0-20mA current input, selected via the terminals S4/S5 on the terminal block.

The percentage corresponding to the input physical quantity of the AI terminal is set by the function codes F02.31 to F02.36. 100.00% is the percentage to the set value of F00.16 (maximum frequency).

F00.04=5: High-frequency pulse input (X5)

The main frequency source A depends on the HDI (percentage) * F00.16.

The terminal X5 can also be used for high-frequency pulse input (set the terminal function F02.04 to “40: pulse input”), with the frequency of 0.00-100.00kHz and voltage of 12-48V. The

corresponding percentage of terminal input pulse frequency is set by F02.06-F02.29. 100.00% is the percentage relative to the set value of F00.16 (maximum frequency).

F00.04=6 or 7: main frequency communication setting

The main frequency source A depends on the communication, etc.

- If the master-slave communication (F10.05=1) is enabled and the inverter works as the slave (F10.06=0), the main frequency source A is set to “700FH (master-slave communication setting) * F00.16 (maximum frequency) * F10.08 (slave receiving proportional coefficient)”, and the 700FH data range is -100.00% to 100.00%, as detailed in Table 12-31.
- For general communication (F10.05=0):
 - a、 **F00.04=6** percentage setting: the main frequency source A is set to “7001H (communication percentage setting of the main channel frequency A) * F00.16 (maximum frequency)”;
 - b、 **F00.04=7** direct frequency setting: the main frequency source A is set to “7015H (communication setting of the main channel frequency A)”

The 7001H data range is -100.00% to 100.00%, and the 7015H data range is 0.00 to F00.16 (maximum frequency), as detailed in Table 12-31.

F00.04=8: digital potentiometer setting

In the speed mode, the main frequency source A is set directly by the digital potentiometer, and only the monitoring interface is available. See F12.42 for the specific value.

Operating instructions for the digital potentiometer: In the monitoring interface, turn the digital potentiometer clockwise or counterclockwise to increase or decrease the set frequency. This is the editing status, and the value will flash if changed. After the change is made, press the ENTER key to exit the editing status. The indicator will no longer flicker. Or, press the ESC key to cancel the current change, exit the editing status and restore the original value. The normal status will be displayed, and the indicator will no long flicker. (After the product is powered on again, this value will still be displayed.) See the running monitoring of keyboard operation.

The final setting of the main frequency source A is also dependent on the DI terminal status:

Table 7-3 Detailed Setting of Main Frequency Source A

Terminal Function	Status Description	Priority
11-14: multi-segment speed terminals 1-4	If one is valid, the multi-segment speed mode will be enabled (F08.00-F08.14).	1
51: switching of main frequency source to digital frequency setting	Valid, depending on the digital frequency setting F00.07, the same as the function code F00.04=0	2
52: switching of main frequency source to AI1	Valid, depending on the AI1 input percentage setting, the same as the function code F00.04=1	3
53: Switching of main frequency source to AI2	Valid, depending on the AI2 input percentage setting, the same as the function code F00.04=2	4
56: switching of main frequency source to communication setting	Valid, depending on the communication input, the same as the function code F00.04=6	7
--	All invalid, depending on the setting of function code F00.04	8

F00.05=0: digital frequency setting F00.07

Function code	Function code name	Parameter description	Unit	Default setting	Attribute
F00.05	Options of auxiliary frequency source B	0: digital frequency setting F00.07 1: AI1 2: AI2 3: retention 4: retention 5: high frequency pulse input (X5) 6: percent setting of auxiliary frequency communication 7: direct setting of auxiliary frequency communication 8: digital potentiometer setting 9: retention 10: process PID 11: simple PLC		0	○

The auxiliary frequency B depends on the digital frequency setting F00.07.

F00.05=1:AI1

F00.05=2:AI2

The auxiliary frequency B is determined by AI (percentage) * F00.16.

For the details of AI1 and AI2, refer to the F00.04 description. They have the same

meaning. 100.00% is the percentage to the set value of F00.16 (maximum frequency).

F00.05=5: High-frequency pulse input (X5)

The auxiliary frequency B is determined by HDI (percentage) * F00.16.

For the details of AI1-AI2 and X5, refer to the F00.04 description. They have the same meaning. 100.00% is the percentage to the set value of F00.16 (maximum frequency).

F00.05=6 or 7: auxiliary frequency communication setting

The auxiliary frequency B depends on the communication and others.

- If the master-slave communication (F10.05=1) is enabled and the inverter works as the slave (F10.06=0), the auxiliary frequency B is set to “700FH (master-slave communication setting) * F00.16 (maximum frequency) * F10.08 (slave receiving proportional coefficient)”, and the 700FH data range is -100.00% to 100.00%, as detailed in Table 12-31.
- For general communication (F10.05=0):
 - a. **F00.05=6**, the auxiliary frequency B is set to “7002H (communication setting of the auxiliary channel frequency B) * F00.16 (maximum frequency)”;
 - b. **F00.05=7**, the auxiliary frequency B is set to “7016H (communication setting of the auxiliary channel frequency B)”.

The 7002H data range is -100.00% to 100.00%, and the 7002H data range is 0.00 to F00.16 (maximum frequency), as detailed in Table 12-31.

F00.05=8: digital potentiometer setting

In the speed mode, the auxiliary frequency B is set directly by the digital potentiometer. See the F00.04 description for details.

F00.05=10: process PID

The auxiliary frequency B depends on the process PID function output, as detailed in 7.10. This is usually applied in on-site closed-loop process control, such as the constant-pressure closed-loop control and constant-tension closed-loop control.

F00.05=11: Simple PLC

The auxiliary frequency B depends on the simple PLC function output, [as detailed in the multi-segment group \(F08\) and simple PLC parameter group.](#)



1. The same physical channel (AI1 or AI2) cannot be selected for the main frequency source A and auxiliary frequency source B;

2. The process PID and simple PLC modules will not be valid until they are selected.

Function code	Function code name	Parameter description	Unit	Default setting	Attribute
F00.06	Options of frequency source	0: main frequency source A 1: auxiliary frequency source B 2: main and auxiliary operation results 3: switching between main frequency source A and auxiliary frequency source B 4: switching between main frequency source A and main and auxiliary operation results 5: switching between auxiliary frequency source B and main and auxiliary operation results		0	○

Select the final valid frequency setting channel and operation mode.

F00.06=0: main frequency source A

The final set frequency only depends on the main frequency source A.

F00.06=1: auxiliary frequency source B

The final set frequency only depends on the auxiliary frequency source B.

F00.06=2: main and auxiliary operation results

The final set frequency depends on the main and auxiliary operation results. Refer to the description of the function code F00.08.

F00.06=3: switching between the main frequency source A and auxiliary frequency source B

The final set frequency is determined by the status of the input function “26: Frequency source switching”: invalid, depending on the main frequency source A; valid, depending on the auxiliary frequency source B.

F00.06=4: switching between main frequency source A and main and auxiliary calculation results

The final set frequency is determined by the status of the input function “26: Frequency source switching”: invalid, depending on the main frequency source A; valid, depending on the main and auxiliary operation results. Refer to the description of the function code F00.08.

F00.06=5: switching between the auxiliary frequency source B and main and auxiliary

operation results

The final set frequency is determined by the status of the input function “26: Frequency source switching”: invalid, depending on the auxiliary frequency source B; valid, depending on the main and auxiliary operation results. Refer to the description of the function code F00.08.

Function code	Function code name	Parameter description	Unit	Default setting	Attribute
F00.07	Digital frequency setting	0.00 to maximum frequency	Hz	50.00	●

F00.07 is used to set the digital frequency, and its maximum value is limited by the maximum frequency (F00.16).

Function code	Function code name	Parameter description	Unit	Default setting	Attribute
F00.08	Options of main and auxiliary operation	0: main frequency source A + auxiliary frequency source B 1: main frequency source A - auxiliary frequency source B 2: larger value of main and auxiliary frequency sources 3: smaller value of main and auxiliary frequency sources		0	○

Select the main and auxiliary operation mode. The final results are limited by the lower frequency limit (F00.19) and upper frequency limit (F00.18).

F00.08=0: main frequency source A + auxiliary frequency source B

The main and auxiliary operation result is the sum of the two items, and may be positive or negative. That is, the result of the forward 20.00Hz and reverse 40.00Hz is reverse 20.00Hz.

F00.08=1: main frequency source A - auxiliary frequency source B

The main and auxiliary operation result is the difference between the two items, and may be positive or negative. That is, the result of the forward 20.00Hz and reverse 40.00Hz is forward 50.00Hz (upper frequency limit F00.18=50.00).

F00.08=2: the larger of main and auxiliary operation results

The main and auxiliary operation result is the larger of the two items, and may be positive or negative. That is, the result of the forward 20.00Hz and reverse 40.00Hz is forward 20.00Hz.

F00.08=3: the smaller of main and auxiliary operation results

The main and auxiliary operation result is the smaller of the two items, and may be positive

or negative. That is, the result of the forward 20.00Hz and reverse 40.00Hz is reverse 40.00Hz.

Function code	Function code name	Parameter description	Unit	Default setting	Attribute
F00.09	Reference options of auxiliary frequency source B in main and auxiliary operation	0: relative to the maximum frequency 1: Relative to main frequency source A		0	○

During the main and auxiliary operations, the range of the auxiliary frequency source B depends on the selected object, maximum frequency by default. If selected relative to the main frequency source A (F00.09=1), the range of the auxiliary frequency source B will change along with that of the main frequency source A (according to the maximum frequency by default).

Function code	Function code name	Parameter description	Unit	Default setting	Attribute
F00.10	Gain of main frequency source	0.0~300.0	%	100.0	●
F00.11	Gain of auxiliary frequency source	0.0~300.0	%	100.0	●
F00.12	Synthetic gain of main and auxiliary frequency sources	0.0~300.0	%	100.0	●
F00.13	Analog adjustment of synthetic frequency	0: synthetic frequency of main and auxiliary channels 1: AI1 * synthetic frequency of main and auxiliary channels 2: AI2 * synthetic frequency of main and auxiliary channels 3: retention 4: retention 5: High frequency pulse (PULSE) * synthetic frequency of main and auxiliary channels		0	○

Such parameters are mainly used to adjust the gain of each setting source, as shown in

Fig. 7-8. Both the main frequency source A and the auxiliary frequency source B have a set gain. When synthesis is selected via the function code F00.06, a synthetic gain will be generated. The final setting is limited by the analog adjustment and upper and lower frequency limits.

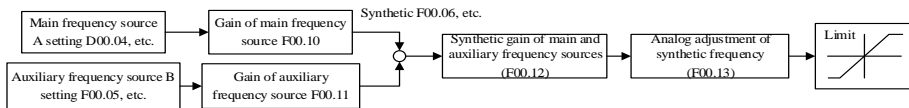

Fig. 7-8 Frequency Source Setting Control (Gain Description)

The gain type function codes (F00.10 to F00.12) are for “multiplication”, i.e. “set value = original set value * gain”. Below is only the description of the analog adjustment (F00.13).

F00.13=0: synthetic frequency of main and auxiliary channels

The synthetic frequency is directly set to the synthetic frequency of main and auxiliary channels.

F00.13=1: AI1 * synthetic frequency of main and auxiliary channels

F00.13=2: AI2 * synthetic frequency of main and auxiliary channels

The synthetic frequency is directly set to “AI (percentage) * synthetic frequency of main and auxiliary channels”.

For the details of AI1-AI2 and X5, refer to the F00.04 description. They have the same meaning. 100.00% is the percentage relative to the main and auxiliary synthetic frequency.

F00.13=5: High frequency pulse (PULSE) * synthetic frequency of main and auxiliary channels

The synthetic frequency is directly set to “HDI (percentage) * synthetic frequency of main and auxiliary channels”.

For the details of AI1-AI2 and X5, refer to the F00.04 description. They have the same meaning. 100.00% is the percentage relative to the main and auxiliary synthetic frequency.

Function code	Function code name	Parameter description	Unit	Default setting	Attribute
F00.14	Acceleration time 1	0.00 - 650.00 (F15.13=0) 0.0 - 6500.0 (F15.13=1) 0 - 65000 (F15.13=2)	s	15.00	●
F00.15	Deceleration time 1	0.00 - 650.00 (F15.13=0) 0.0 - 6500.0 (F15.13=1) 0 - 65000 (F15.13=2)	s	15.00	●

The acceleration time is the time for the output frequency to rise from 0.00Hz to the set value Fbase of F15.09 (reference frequency of the acceleration and deceleration time); and the deceleration time is the time for the output frequency to fall from Fbase to 0.00Hz, regardless of forward and reverse running. See Fig. 7-9.

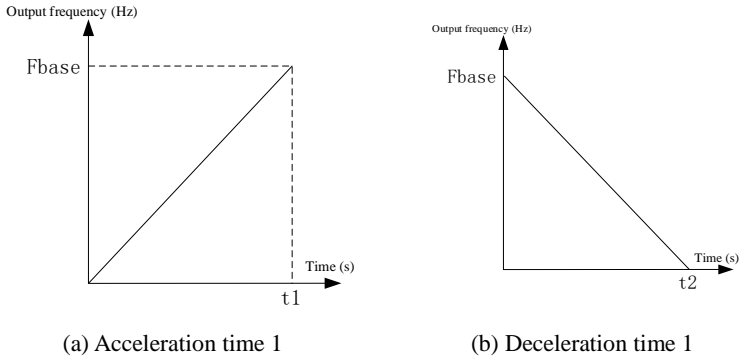

Fig. 7-9 Acceleration and Deceleration Time

Note that the acceleration and deceleration time is in 0.01 s, 0.1 s or 1s, depending on the F15.13.

Function code	Function code name	Parameter description	Unit	Default setting	Attribute
F00.16	Maximum frequency	1.00~600.00	Hz	50.00	○

The allowable maximum frequency of the inverter is represented by Fmax. The Fmax range is from 20.00 to 600.00Hz.

Function code	Function code name	Parameter description	Unit	Default setting	Attribute
F00.17	Options of upper frequency limit control	0: set by F00.18 1: AI1 2: AI2 3: retention 4: retention 5: high frequency pulse input (X5) 6: percent setting of upper limit frequency communication 7: direct setting of upper limit frequency communication		0	○
F00.18	Upper frequency limit	Lower frequency limit F00.19 to maximum frequency F00.16	Hz	50.00	●

F00.19	Lower frequency limit	0.00 to upper frequency limit F00.18	Hz	0.00	●
--------	-----------------------	--------------------------------------	----	------	---

F00.17=0: set by F00.18

The upper frequency limit is set by F00.18.

F00.17=1:AI1

F00.17=2:AI2

The upper frequency limit depends on AI (percentage) * F00.18.

For the details of AI1 and AI2, refer to the F00.04 description. They have the same meaning. 100.00% is the percentage relative to the set value of F00.18 (upper frequency limit).

F00.17=5: High-frequency pulse input (X5)

The upper frequency limit depends on HDI (percentage) * F00.18.

For the details of AI1-AI2 and X5, refer to the F00.04 description. They have the same meaning. 100.00% is the percentage relative to F00.18 (maximum frequency).

F00.17=6 or 7: communication setting

The torque depends on the communication and the like.

- If the master-slave communication (F10.05=1) is enabled, and the inverter works as the slave (F10.06=0), the actual upper frequency limit is “700FH (master-slave communication setting) * F10.08 (slave receiving proportional coefficient) * F00.18 (upper frequency limit)”, and the 700FH data range is -100.00% to 100.00%, as detailed in Table 12-31.

- For general communication (F10.05=0):

- a. **F00.17=6**, the actual frequency limit is “700AH (communication setting of the upper frequency limit) * F00.18 (upper frequency limit)”.
- b. **F00.17=7**, the actual frequency limit is “7017H (communication setting of the upper frequency limit)”.

The 700AH data range is 0.00% to 200.00%, and the 7017H data range is 0.00 to F00.16 (maximum frequency). For details, see Table 12-31.

F00.18 is the highest frequency allowed after the inverter is started. It is represented by Fup, ranging from Fdown to Fmax;

F00.19 is the lowest frequency allowed after the inverter is started. It is represented by Fdown, ranging from 0.00Hz to Fup.

-  1. The upper and lower frequency limits should be set carefully according to the nameplate parameters and operating conditions of the actually controlled motor, and the motor should be prevented from long-time operation at the low frequency; otherwise, the motor life may be shortened due to overheat.
2. Relationship of the maximum frequency, upper frequency limit and lower frequency limit: $0.00\text{Hz} \leq F_{\text{down}} \leq F_{\text{up}} \leq F_{\text{max}} \leq 600.00\text{Hz}$;
3. When the set frequency is lower than F00.19 (lower frequency limit), the running mode is dependent on F15.33.

Function code	Function code name	Parameter description	Unit	Default setting	Attribute
F00.20	Running direction	0: consistent direction 1: opposite direction		0	●

The rotation direction of the motor can be changed by modifying this function code instead of motor wiring. This is equivalent to the change in the rotation direction of the motor by adjusting any two wires of the motor (U, V, W).

1. After the parameters are initialized, the rotation direction of the motor will return to its original status.
-  2. Be careful to conduct the aforesaid operation where it is forbidden to change the rotation direction of the motor after system debugging.
3. When the inverter is prohibited from reverse running (e.g. F00.21=1), this function is invalid.

Function code	Function code name	Parameter description	Unit	Default setting	Attribute
F00.21	Reverse control	0: Allow forward/reverse running 1: Prohibit reversing		0	○
F00.22	Duration of forward and reverse dead zone	0.00~650.00	s	0.00	●

F00.21=0: reversing running is allowed.

The rotation direction of the motor is controlled by the setting of the F/R terminal or F00.20.

F00.21=1: reverse running is prohibited.

The motor can only work in one direction, and the F/R terminal and F00.20 are invalid.

Select the forward/reverse status of the motor.

If F00.22=0.00 is set, forward and reverse running is subject to smooth transition.

If F00.22≠0 is set, when the speed drops to 0.00Hz during forward and reverse switching,

the inverter will work at 0.00Hz within the duration of the forward and reverse dead zone (F00.22) and then in the opposite direction to the set frequency. See Fig. 7-10.

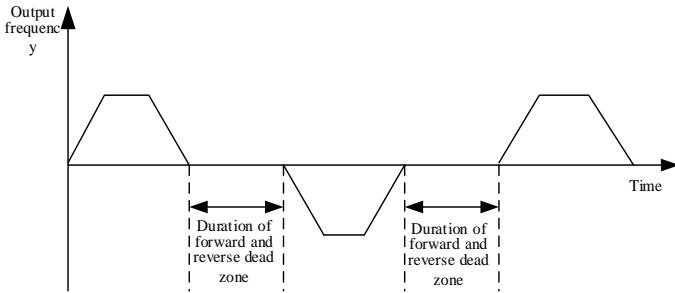



Fig. 7-10 Schematic Diagram of Duration of Forward/Reverse Dead Zone

 When reverse running is allowed, the running direction of the inverter depends on the status of the F/R terminal and the set value of F00.20. If the set forward running direction of the inverter is inconsistent with the desired rotation direction of the motor, exchange any two of the output terminal wires (U, V, W) of the inverter, or set F00.20 to the opposite value.

Function code	Function code name	Parameter description	Unit	Default setting	Attribute
F00.23	Carrier frequency	1.0-16.0 (rated power of the inverter: less than 4.00kW) 1.0-10.0 (rated power of the inverter: 5.50-7.50kW) 1.0 - 8.0 (rated power of inverter 11.00 - 45.00kW) 1.0 - 4.0 (rated power of inverter 55.00 - 90.00kW) 1.0-3.0 (rated power of inverter: 110.00kW and above)	kHz	4.0 (7.5 and below) /2.0	●

Increasing the carrier frequency can reduce the motor noise, but will lead to the heat increase of the inverter. When the carrier frequency is higher than the default value and increased by 1kHz, the load needs to be derated to some extent. Please set F00.24=1. The actual carrier frequency of the inverter will be adjusted automatically according to the actual situation.

The recommended relationship between the rated power and carrier frequency of the inverter is shown in Table 7-4.

Table 7-4 Relationship between Rated Power and Carrier Frequency Setting of Inverter

Inverter power Pe	Pe≤4kW	5.5kW~7.5kW	11kW~ 45kW	55kW~ 90kW	110kW~ 560kW
Rated carrier frequency	4.0kHz		2.0kHz		
Maximum allowable carrier frequency	16.0 kHz	10.0kHz	8.0kHz	4.0kHz	3.0kHz

Function code	Function code name	Parameter description	Unit	Default setting	Attribute
F00.24	Automatic adjustment of carrier frequency	0: Invalid 1: valid 1 2: valid 2		1	○

F00.24=0: invalid

The carrier frequency is dependent on F00.23, but limited by the allowable maximum carrier frequency. It will not change during operation.

F00.24=1: valid 1

The carrier frequency is affected by the inverter temperature and load based on the F00.23 setting. If the inverter temperature is too high or the load is too heavy, the carrier frequency will be limited. When the set carrier frequency F00.23 is greater than the limit, the carrier frequency of the inverter will be the limit during operation.

F00.24=2: valid 2

The carrier frequency is auto-tuned on the basis of the F00.23 setting.

Function code	Function code name	Parameter description	Unit	Default setting	Attribute
F00.25	Noise suppression of carrier frequency	0: Invalid 1: valid		0	○
F00.27	Noise suppression intensity	10~150	Hz	100	●

When the noise suppression function is enabled (F00.25=1), the motor noise can be suppressed to a certain extent.

Function code	Function code name	Parameter description	Unit	Default setting	Attribute
F00.28	Options of motor	0: parameter group of motor		0	○

	parameter group	1 1: parameter group of motor 2			
--	-----------------	---------------------------------------	--	--	--

The EM730/EM730E series inverter supports time-sharing control of two motors. The motor parameters and control parameters can be set separately. The corresponding parameters of the motor 1 are in the F00 group, F01 group and F06 group, and those of the motor 2 are in the F14 group.

The valid motor can be selected in conjunction with F00.28 and the input function “Motor 1/Motor 2 switching”, as detailed in Table 7-5.

Table 7-5 Details of Motor Parameter Group Options

F00.28: Motor parameter group options	30: motor 1/motor 2 switching	Valid motor	Related parameter group
0: parameter group of motor 1	Invalid	Motor 1	F00/F01/F06
	Valid	Motor 2	F14
1: parameter group of motor 2	Invalid	Motor 2	
	Valid	Motor 1	F00/F01/F06

Function code	Function code name	Parameter description	Unit	Default setting	Attribute
F00.29	User password	0 - 65535		0	○

F00.29 is used to set a password to enable the password protection and prevent the function code parameters of the inverter from modification by unauthorized personnel. If the password is set to 0, the password function will be invalid. When a non-zero user password is set, all parameters (except this function code) can only be viewed and are not modifiable.

Function code	Function code name	Parameter description	Unit	Default setting	Attribute
F00.31	Frequency resolution	0: 0.01Hz 1: 0.1Hz (speed unit: 10rpm)		0	○

F00.31=0: The frequency resolution is 0.01Hz, corresponding to the frequency of 50.00Hz. The maximum frequency in this mode is 600.00Hz.

F00.31=1: The frequency resolution is 0.1Hz, corresponding to the frequency of 50.00Hz. The maximum frequency in this mode is 3000.0Hz. It is suitable for high-frequency spindle motors.

Function code	Function code name	Parameter description	Unit	Default setting	Attribute
F00.35	Power supply voltage selection	0: 380V 1: 440V		0	○

F00.55=0: 380V

The voltage of the applied power supply is 380V.

F00.55=1: 440V

The voltage of the applied power supply is 440V. When the function code is set to 440V, the corresponding dynamic braking voltage and stall overvoltage will increase accordingly.

7.2 Motor 1 parameter group of F01 group

Function code	Function code name	Parameter description	Unit	Default setting	Attribute
F01.00	Motor type	0: ordinary asynchronous motor 1: variable-frequency asynchronous motor 2: permanent magnet synchronous motor		0	○

The EM730/EM730E series inverter supports asynchronous and synchronous motors. Please set this parameter correctly according to the actual situation.

Function code	Function code name	Parameter description	Unit	Default setting	Attribute
F01.01	Rated power of electric motor	0.10~650.00	kW	Depending on the motor type	○
F01.02	Rated voltage of motor	50~2000	V	Depending on the motor type	○
F01.03	Rated current of motor	0.01 to 600.00 (rated power of motor: ≤ 75 kW) 0.1 to 6000.0 (rated power of motor: > 75 kW)	A	Depending on the motor type	○
F01.04	Rated frequency of motor	0.01~600.00	Hz	Depending on the motor type	○
F01.05	Rated speed	1~60000	rpm	Depending	○

				on the motor type	
F01.06	Motor winding connection	0:Y 1:Δ		Depending on the motor type	○
F01.07	Rated power factor of motor	0.600~1.000		Depending on the motor type	○
F01.08	Motor efficiency	30.0~100.0	%	Depending on the motor type	○

The above function codes are the nameplate parameters of the asynchronous motor. When the motor is connected to the inverter for the first time, regardless of VF control or vector control, the above parameters must be correctly set according to the motor nameplate before operation.

When the rated power (F01.01) of the motor is changed, the values of F01.03 to F01.08 of the inverter will change automatically. Pay attention to this during operation.

Function code	Function code name	Parameter description	Unit	Default setting	Attribute
F01.09	Stator resistance of asynchronous motor	1-60000 (rated power of motor: ≤ 75 kW) 0.1-6000.0 (rated power of motor: > 75kW)	mΩ	Depending on the motor type	○
F01.10	Rotor resistance of asynchronous motor	1-60000 (rated power of motor: ≤ 75 kW) 0.1-6000.0 (rated power of motor: > 75kW)	mΩ	Depending on the motor type	○
F01.11	Leakage inductance of asynchronous motor	0.01 to 600.00 (rated power of motor: ≤ 75 kW) 0.001 to 60.000 (rated power of motor: > 75 kW)	mH	Depending on the motor type	○
F01.12	Mutual inductance of asynchronous motor	0.1 to 6000.0 (rated power of motor: ≤ 75 kW) 0.01 to 600.00 (rated power of motor: > 75 kW)	mH	Depending on the motor type	○

F01.13	No-load excitation current of asynchronous motor	0.01 to 600.00 (rated power of motor: ≤ 75 kW) 0.1 to 6000.0 (rated power of motor: > 75 kW)	A	Depending on the motor type	○
--------	--	--	---	-----------------------------	---

The function codes F01.09 to F01.13 are the parameters of the asynchronous motor. They are usually unavailable to users. Please get them through motor parameter self-identification (F01.34).

When the motor parameters (F01.01 to F01.08) are modified, the values of F01.09 to F01.13 of the inverter will change automatically. Pay attention to this during operation.

Before the motor parameter self-identification, be sure to set F01.00 to F01.08 correctly according to the actual situation.

The specific meanings of motor parameters are shown in Fig. 7-11:

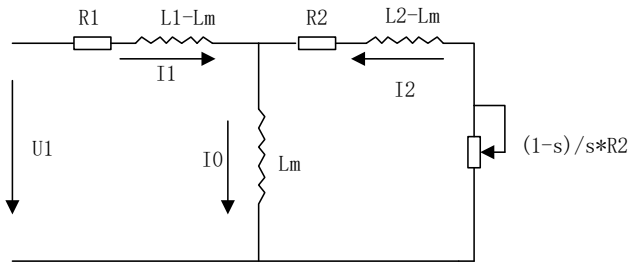

Fig. 7-11 Steady-state Equivalent Model of Asynchronous Motor

R_1 , L_1 , R_2 , L_2 , L_m , and I_0 in the figure represent: stator resistance, stator inductance, rotor resistance, rotor inductance, mutual inductance, no-load excitation current.

Function code	Function code name	Parameter description	Unit	Default setting	Attribute
F01.14	Magnetic saturation coefficient 1 of asynchronous motor	10.00 - 100.00	%	87.00	○
F01.15	Magnetic saturation coefficient 2 of asynchronous motor	10.00 - 100.00	%	80.00	○
F01.16	Magnetic saturation coefficient 3 of asynchronous motor	10.00 - 100.00	%	75.00	○
F01.17	Magnetic saturation	10.00 - 100.00	%	72.00	○

	coefficient 4 of asynchronous motor				
F01.18	Magnetic saturation coefficient 5 of asynchronous motor	10.00 - 100.00	%	70.00	○

The magnetic saturation coefficient of the asynchronous motor is automatically set during the motor parameter self-identification. Users do not need to set it under normal circumstances.

Function code	Function code name	Parameter description	Unit	Default setting	Attribute
F01.19	Stator resistance of synchronous motor	1-60000 (rated power of motor: ≤75kW) 0.1 to 6000.0 (rated power of motor: > 75 kW)	mΩ	Model Confirm	○
F01.20	d-axis inductance of synchronous motor	0.01 to 600.00 (rated power of motor: ≤ 75 kW) 0.001 to 60.000 (rated power of motor: > 75 kW)	mH	Model Confirm	○
F01.21	q-axis inductance of synchronous motor	0.01 to 600.00 (rated power of motor: ≤ 75 kW) 0.001 to 60.000 (rated power of motor: > 75 kW)	mH	Model Confirm	○
F01.22	Counter electromotive force of synchronous motor	10.0-2000.0 (counter electromotive force of rated speed)	V	Model Confirm	○
F01.23	Initial electrical angle of synchronous motor	0.0-359.9 (valid for synchronous motor)		0.0	○

The function codes F01.19 to F01.23 are the parameters of the synchronous motor. They are usually unavailable to users. Please get them through motor parameter self-identification (F01.34).

Before the motor parameter self-identification, be sure to set F01.00 to F01.08 correctly according to the actual situation. In particular, select the motor type (F01.00=2) correctly.

Function code	Function code name	Parameter description	Unit	Default setting	Attribute
F01.34	Motor parameter self-learning	0: No operation 1: static self-learning of		0	○

		asynchronous motor 2: rotation self-learning of asynchronous motor 11: static self-learning of synchronous motor 12: rotary self-learning of synchronous motor			
--	--	---	--	--	--

F01.34=0: not identified

F01.34=1: the asynchronous motor remains stationary during parameter self-identification.

Prior to the static self-learning of the asynchronous motor, please set the motor type (F01.00) and motor nameplate parameters (F01.01 to F01.08) correctly. Relevant parameters (F01.09 to F01.13) of the asynchronous motor can be obtained during static self-learning.

This mode is mainly used when the motor cannot rotate. Static self-learning has poorer effects than rotary self-learning.

F01.34=2: the asynchronous motor rotates during parameter self-identification.

Prior to the rotary self-learning of the asynchronous motor, please set the motor type (F01.00) and motor nameplate parameters (F01.01 to F01.08) correctly. Relevant parameters (F01.09 to F01.18) of the asynchronous motor can be obtained during rotary self-learning.

This mode is mainly used when the motor can rotate. However, loads should be avoided or minimized; otherwise, self-learning will have poor effects.

F01.34=11: the synchronous motor remains stationary during parameter self-identification.

Prior to the static self-learning of the synchronous motor, please set the motor type (F01.00) and motor nameplate parameters (F01.01 to F01.05) correctly. Relevant parameters (F01.19 to F01.21) of the synchronous motor and current loop parameters (F06.12 to F06.15) can be obtained during static self-learning.



This mode is mainly used when the motor cannot rotate. It is necessary to manually enter the counter electromotive force (F01.22).

F01.34=12: the synchronous motor rotates during parameter self-identification.

Prior to the rotary self-learning of the synchronous motor, please set the motor type (F01.00) and motor nameplate parameters (F01.01 to F01.05) correctly. Relevant parameters (F01.19 to F01.21) of the synchronous motor, current loop parameters (F06.12 to F06.15) and counter electromotive force (F01.22) can be obtained during rotary self-learning.

This mode is mainly used when the motor can rotate. However, loads should be avoided or minimized; otherwise, self-learning will have poor effects.



1. Motor parameter self-learning is valid only in the keyboard-controlled start/stop mode (F00.02=0): Set F01.34 to the corresponding value, and press the ENTER key  for confirmation and then the RUN key  to start motor parameter self-learning. After the parameter self-learning, F01.34 of the inverter will be automatically set to 0;

2. If there is an overcurrent or overvoltage protection during self-learning, extend the acceleration and deceleration time and try again.

3. The first group of motor parameters is taken as an example above. For the second group of motor parameters, refer to the above description.

7.3 Function Parameter Group of Input Terminal of F02 Group

The standard EM730/EM730E series inverter is equipped with five multi-function digital input terminals (X1 to X5) and two analog input terminals (AI1 and AI2, to be used with the corresponding function set to digital input, as detailed in the F02.31 description).

Function code	Function code name	Parameter description	Unit	Default setting	Attribute
F02.00	Options of X1 digital input function	See Table 7-6 Function List of Multi-function Digital Input Terminals		1	○
F02.01	Options of X2 digital input function			2	○
F02.02	Options of X3 digital input function			11	○
F02.03	Options of X4 digital input function			12	○
F02.04	Options of X5 digital input function			13	○
F02.07	Options of AI1 digital input function			0	○
F02.08	Options of AI2 digital input function			0	○

The terminals X1 to X5, AI1 and AI2 are seven multi-function input terminals. The functions of the input terminals can be defined by setting the values of the function codes F02.00 to F02.14.

For example, if you define F02.00=1, the function of the X1 terminal is “RUN”. If the command source is set to terminal control (F00.02=1) and the X1 terminal input is valid, the “RUN” function of the inverter will be enabled. Specific options are described in Table 7-6.

If multiple terminals are set to the same function (except for #34 function terminal), the

function status is dependent on the “OR logic” of the two terminals. In the case of F02.00=1 and F02.04=1, once one of the terminals X1 or X5 is valid, the “RUN” function of the inverter will be enabled.

Table 7-6 Function List of Multi-function Digital Input Terminals

Settings	Function	Description
0	No function	Disable the protection terminal or set it to “0: Unavailable” to prevent malfunction.
1	Running terminal (RUN)	When the command source is set to terminal control (F00.02=1), and the function terminal is valid, the inverter will execute the corresponding RUN function according to the set value of the terminal control mode option (F00.03). (See the explanation of the function code F00.03 for details.)
2	Running direction F/R	When the command source is set to terminal control (F00.02=1), and the function terminal is valid, the inverter will execute the corresponding F/R function according to the set value of the terminal control mode option (F00.03). (See the explanation of the function code F00.03 for details.)
3	Stop control of three-line operation	When the command source is set to terminal control (F00.02=1), the terminal control mode is set to three-line control (F00.03=2/3) and the function terminal is valid, the inverter will execute the stop command. (See the explanation of the function code F00.03 for details.)
4	Forward jog (FJOG)	When the command source is set to terminal control (F00.02=1), and the function terminal FJOG is valid, the inverter will run forward; if the function terminal RJOG is valid, the inverter will run reversely; and if the two function terminals are valid at the same time, the inverter will decelerate to stop. ★: When reverse running is prohibited, the reverse jog will be invalid.
5	Reverse jog (RJOG)	
6	Terminal UP	If the function terminal UP is valid, the frequency offset will be increase at the rate defined by F12.11; and if the function terminal DOWN is valid, the frequency offset will decrease at the rate defined by F12.11. If the UP/DOWN offset clear terminal is valid, the frequency offset will be cleared to 0.
7	Terminal DOWN	
8	Clear UP/DOWN offset	Final set frequency of the frequency source A = set frequency of the frequency source A + UP/DOWN offset. ★: The UP/DOWN function is valid only when the main frequency source A is involved in setting. The offset frequency can be viewed via F18.15. The function of the terminal UP/DOWN is the same as that of

		the UP/DOWN on the keyboard.																																																																																					
9	Free stop	If this function terminal is valid during inverter operation, the output will be blocked, the inverter will stop in the free status, and the motor will not be controlled by the inverter.																																																																																					
10	Reset protection	If the inverter is subject to protection and the faulty point is eliminated, you can use this terminal to reset the inverter. This has the same function as the Reset key on the keyboard.																																																																																					
11	Multi-segment speed terminal 1	When the speed control and main frequency source A are involved in setting, four function input terminals can be defined as multi-segment speed terminals. The current set frequency of the inverter depends on the code combination of these four terminals and the settings of related function codes. Details are given in the following table. (0/1: the current function terminal is invalid/valid.)																																																																																					
12	Multi-segment speed terminal 2	<p>★: When a function has no corresponding input terminal options, it is invalid (0) by default.</p> <table border="1"> <thead> <tr> <th>14</th> <th>13</th> <th>12</th> <th>11</th> <th>Set frequency of the inverter</th> </tr> </thead> <tbody> <tr> <td>0</td> <td></td> <td></td> <td></td> <td>Depending on the option (F00.04) of the main frequency source A</td> </tr> <tr> <td>0</td> <td>0</td> <td>0</td> <td>1</td> <td>Multi-segment speed 1 (F08.00)</td> </tr> <tr> <td>0</td> <td>0</td> <td>1</td> <td>0</td> <td>Multi-segment speed 2 (F08.01)</td> </tr> <tr> <td>0</td> <td>0</td> <td>1</td> <td>1</td> <td>Multi-segment speed 3 (F08.02)</td> </tr> <tr> <td>0</td> <td>1</td> <td>0</td> <td>0</td> <td>Multi-segment speed 4 (F08.03)</td> </tr> <tr> <td>0</td> <td>1</td> <td>0</td> <td>1</td> <td>Multi-segment speed 5 (F08.04)</td> </tr> <tr> <td>0</td> <td>1</td> <td>1</td> <td>0</td> <td>Multi-segment speed 6 (F08.05)</td> </tr> <tr> <td>0</td> <td>1</td> <td>1</td> <td>1</td> <td>Multi-segment speed 7 (F08.06)</td> </tr> <tr> <td>1</td> <td>0</td> <td>0</td> <td>0</td> <td>Multi-segment speed 8 (F08.07)</td> </tr> <tr> <td>1</td> <td>0</td> <td>0</td> <td>1</td> <td>Multi-segment speed 9 (F08.08)</td> </tr> <tr> <td>1</td> <td>0</td> <td>1</td> <td>0</td> <td>Multi-segment speed 10 (F08.09)</td> </tr> <tr> <td>1</td> <td>0</td> <td>1</td> <td>1</td> <td>Multi-segment speed 11 (F08.10)</td> </tr> <tr> <td>1</td> <td>1</td> <td>0</td> <td>0</td> <td>Multi-segment speed 12 (F08.11)</td> </tr> <tr> <td>1</td> <td>1</td> <td>0</td> <td>1</td> <td>Multi-segment speed 13 (F08.12)</td> </tr> <tr> <td>1</td> <td>1</td> <td>1</td> <td>0</td> <td>Multi-segment speed 14 (F08.13)</td> </tr> <tr> <td>1</td> <td>1</td> <td>1</td> <td>1</td> <td>Multi-segment speed 15 (F08.14)</td> </tr> </tbody> </table>	14	13	12	11	Set frequency of the inverter	0				Depending on the option (F00.04) of the main frequency source A	0	0	0	1	Multi-segment speed 1 (F08.00)	0	0	1	0	Multi-segment speed 2 (F08.01)	0	0	1	1	Multi-segment speed 3 (F08.02)	0	1	0	0	Multi-segment speed 4 (F08.03)	0	1	0	1	Multi-segment speed 5 (F08.04)	0	1	1	0	Multi-segment speed 6 (F08.05)	0	1	1	1	Multi-segment speed 7 (F08.06)	1	0	0	0	Multi-segment speed 8 (F08.07)	1	0	0	1	Multi-segment speed 9 (F08.08)	1	0	1	0	Multi-segment speed 10 (F08.09)	1	0	1	1	Multi-segment speed 11 (F08.10)	1	1	0	0	Multi-segment speed 12 (F08.11)	1	1	0	1	Multi-segment speed 13 (F08.12)	1	1	1	0	Multi-segment speed 14 (F08.13)	1	1	1	1	Multi-segment speed 15 (F08.14)
14	13	12	11	Set frequency of the inverter																																																																																			
0				Depending on the option (F00.04) of the main frequency source A																																																																																			
0	0	0	1	Multi-segment speed 1 (F08.00)																																																																																			
0	0	1	0	Multi-segment speed 2 (F08.01)																																																																																			
0	0	1	1	Multi-segment speed 3 (F08.02)																																																																																			
0	1	0	0	Multi-segment speed 4 (F08.03)																																																																																			
0	1	0	1	Multi-segment speed 5 (F08.04)																																																																																			
0	1	1	0	Multi-segment speed 6 (F08.05)																																																																																			
0	1	1	1	Multi-segment speed 7 (F08.06)																																																																																			
1	0	0	0	Multi-segment speed 8 (F08.07)																																																																																			
1	0	0	1	Multi-segment speed 9 (F08.08)																																																																																			
1	0	1	0	Multi-segment speed 10 (F08.09)																																																																																			
1	0	1	1	Multi-segment speed 11 (F08.10)																																																																																			
1	1	0	0	Multi-segment speed 12 (F08.11)																																																																																			
1	1	0	1	Multi-segment speed 13 (F08.12)																																																																																			
1	1	1	0	Multi-segment speed 14 (F08.13)																																																																																			
1	1	1	1	Multi-segment speed 15 (F08.14)																																																																																			
13	Multi-segment speed terminal 3																																																																																						
14	Multi-segment speed terminal 4																																																																																						
15	Multi-segment PID terminal 1	The 4-segment PID setting can be performed via these two terminals, as detailed in the following table (0/1: the current function terminal is invalid/valid).																																																																																					
16	Multi-segment PID terminal 2	<table border="1"> <thead> <tr> <th>16</th> <th>15</th> <th>Multi-segment PID setting</th> </tr> </thead> <tbody> <tr> <td>0</td> <td>0</td> <td>Depending on the PID setting source (F09.00)</td> </tr> <tr> <td>0</td> <td>1</td> <td>Multi-segment PID setting 1 (F09.32)</td> </tr> <tr> <td>1</td> <td>0</td> <td>Multi-segment PID setting 2 (F09.33)</td> </tr> </tbody> </table>	16	15	Multi-segment PID setting	0	0	Depending on the PID setting source (F09.00)	0	1	Multi-segment PID setting 1 (F09.32)	1	0	Multi-segment PID setting 2 (F09.33)																																																																									
16	15	Multi-segment PID setting																																																																																					
0	0	Depending on the PID setting source (F09.00)																																																																																					
0	1	Multi-segment PID setting 1 (F09.32)																																																																																					
1	0	Multi-segment PID setting 2 (F09.33)																																																																																					

		1	1	Multi-segment PID setting 3 (F09.34)
17	Multi-segment torque terminal 1	The 4-segment torque setting can be performed via these two terminals, as detailed in the following table (0/1: the current function terminal is invalid/valid).		
		18	17	Multi-segment torque setting
18	Multi-segment torque terminal 2	0	0	Depending on the torque setting source option (F13.01)
		0	1	Multi-segment torque 1 (F13.03)
		1	0	Multi-segment torque 2 (F13.04)
		1	1	Multi-segment torque 3 (F13.05)
19	Acceleration and deceleration time terminal 1	The inverters of this series have four groups of acceleration and deceleration time in total. You can define two function input terminals as acceleration and deceleration time terminals. The current acceleration/deceleration time of the inverter depends on the code combination of these four terminals and settings of related function codes. Details are given in the following table. (0/1: the current function terminal is invalid/valid); or see the function codes F15.03 to F15.13 for details.		
		20	19	Acceleration and deceleration time
20	Acceleration and deceleration time terminal 2	0	0	The first group (acceleration time: F00.14; deceleration time: F00.15)
		0	1	The second group (acceleration time: F15.03; deceleration time: F15.04)
		1	0	The third group (acceleration time: F15.05; Deceleration time: F15.06)
		1	1	The fourth group (acceleration time: F15.07; Deceleration time: F15.08)
21	Acceleration and deceleration prohibition	When the acceleration and deceleration prohibition terminal is valid, the execution of acceleration and deceleration commands will be prohibited, and the output frequency of the inverter will remain unchanged. The inverter in the overcurrent protection status will run based on the current limit.		
22	Operation pause	The inverter decelerates to stop, but all running parameters will be kept in the memory, such as PLC and PID parameters. When this terminal is invalid, the inverter will restore the running status before stop.		
23	External protection input	Using this terminal, you can input the protection signal of the external device, to facilitate protection monitoring and protection of the external device via the inverter. Upon receiving an external protection signal, the inverter will display		

		“E14” and freely stop running.
24	Switching of RUN command to keyboard	The current command channel depends on the status of these two terminals and setting of F00.02. The priority is as follows: “24: switching of RUN command to keyboard” > “25: switching of RUN command to communication” > “F00.02: command source option”. Refer to the F00.02 description for details.
25	Switching of RUN command to communication	
26	Frequency source switching	This terminal is mainly used to switch the frequency sources in conjunction with the function code F00.06. When F00.06=3 to 5, this terminal will be valid. Refer to the F00.06 description.
27	Clearing of regular running time	The regular running function is defined by F16.05. This terminal can be used to clear the running time (reset the remaining time of regular running). Refer to the F16.05 description.
28	Speed control/torque control switching	These two terminals are used to change the current inverter control mode in conjunction with F13:00. When #28 terminal is valid, speed control and torque control can be switched; and when #29 terminal is valid, only speed control is enabled. See the F13.00 description.
29	Torque control prohibition	
30	Motor 1/Motor 2 switching	This terminal is used to determine the current valid motor in conjunction with F00.28. If #30 terminal is valid, the motors will be switched based on the F00.28 setting. See the F00.28 description.
31	Resetting of simple PLC status (running from the first segment, with the running time cleared)	When this terminal is valid, the simple PLC module will restart running from the first segment. To further understand this function, you can view the simple PLC description of the F08 group.
32	simple PLC time pause (keep running at current segment)	When this terminal is valid, the simple PLC module will keep running at the current segment. When this terminal is invalid, the simple PLC module will continue to run after running at the current segment.
33	Reserved	
34	counter input ($\leq 250\text{Hz}$)	It is a pulse input terminal that has the counting function. The input pulse frequency is limited to 250Hz or below, and only one terminal can be set with this function. See the description of the function codes F16.03 to F16.04.
35	High-speed count input ($\leq 100\text{kHz}$, only valid for X5)	It is a pulse input terminal that has the counting function. The input pulse frequency is limited to 100kHz or below. This is valid only for the terminal X5 (that is, only F02.06=35 can be set). See the description of the function codes F16.03 to F16.04.
36	Count clearing	This terminal is used to clear the counter that has a counting

		function.
37	Length counter input ($\leq 250\text{Hz}$)	This is the pulse input terminal that has a length counting function, the input pulse frequency is limited to 250Hz or below, and only one terminal can be set with this function. See the description of the function codes F16.01 to F16.02.
38	High-speed length count input ($\leq 100\text{kHz}$, only valid for X5)	This is the pulse input terminal that has a length counting function, and the input pulse frequency is limited to 100kHz or below. It is invalid only for the terminal X5 (that is, only F02.06=38 can be set). See the description of the function codes F16.01 to F16.02.
39	Length clearing	This length clearing terminal has a length counting function.
40	Pulse input ($\leq 100\text{kHz}$, only valid for X5)	This is a pulse signal input terminal, and the input pulse frequency is limited to 100kHz or below. It is valid only for the terminal X5. ★: This is used only to set the equivalent AI percentage instead of other special functions (e.g. counting). When F00.04=5, you need to set F02.06=40 and the set frequency pulse needs to be inputted from the terminal X5.
41	Process PID pause	When this terminal is valid, PID adjustment will be stopped, and the output of the process PID module will remain unchanged. For more information, refer to the description of the function code F09.18.
42	Process PID integral pause	When this terminal is valid, the PID integral adjustment will be suspended, but the proportional and differential adjustment of the PID will be still valid. This function is known as integral separation. See the F09.20 description.
43	PID parameter switching	If the digital input terminal (F09.11=1) for PID parameter switching is valid, PID parameters will be switched. See the description of the function codes F09.05 to F09.13.
44	PID positive/negative switching	When this terminal is valid, the PID positive/negative modes will be switched. See the description of the function code F09.04.
45	Stop and DC braking	When a stop command is triggered and the frequency reaches the starting frequency (F04.20) for direct braking during stop, braking will be enabled. The braking time is subject to the longer of the terminal closing time and stop/DC braking time (F04.22).
46	DC braking at stop	The stop command is not triggered. When there is a stop command, and the frequency reaches the starting frequency (F04.20) for direct braking during stop, braking will be enabled. The braking time is subject to the longer of the terminal closing time and stop/DC braking time (F04.22).
47	Immediate DC	The inverter will immediately stop running and be subject to

	braking	DC braking at the current frequency. The braking current is dependent on the DC braking current (F04.21) in stop.
48	Fastest deceleration to stop	The inverter will stop running within the minimum allowable acceleration and deceleration time.
49	Reserved	
50	External stop	When this terminal is valid, the inverter will stop running according to the set stop mode (F04.19) and acceleration/deceleration time 4 (F15.07/F15.08).
51	Switching of main frequency source to digital frequency setting	When the main frequency source A is involved in setting, the multi-segment speed model is not enabled and this terminal is valid, the main frequency source will be switched to the corresponding setting. The functions 51 to 56 can work independently, but subject to the priority. See the description of the function code F00.04Table 7-3.
52	Switching of main frequency source to AI1	
53	Switching of main frequency source to AI2	
55	Switching of main frequency source to high-frequency pulse input	
56	Switching of main frequency source to communication setting	
57	Inverter enabling	When the inverter meets the operating conditions and the current function terminal is valid, the inverter is able to run. Otherwise, it will not run even if other operating conditions are met. ★: Inverter enabling function: If no terminal is selected, this function is valid by default; if one terminal is selected, the status of the selected terminal will prevail; and if more than one terminal is selected and any selected terminal is invalid, this function will not be valid.
58 - 67	Reserved	
68	Prohibition of reversing disabling	It is only applicable to the straight wire drawing machines in winding applications. 1: When the function of 69# input terminal is available and/or F00.21=1, 68# input terminal is available, and reversing disabling is prohibited, that is, reversing is allowed; otherwise, reversing disabling is not prohibited, that is, reversing is not allowed.

		2: When the function of 69# input terminal is available and/or F00.21=1, 68# input terminal is available, and reversing is disabled, that is, reversion is not allowed; otherwise, reversing disabling is not disabled, that is, reversing is allowed.
69	Prohibition of reversing	When this terminal is valid, its function is the same as that in the case of F00.21=1.
70 - 78	Reserved	
121	External material cutoff signal	This is a dedicated function for winding applications, which is used for external input of material cutoff detection. When material cutoff detection is an external signal and the terminal is closed (consistent with restrictions), E43 protection will be reported.
122	Wiring detection signal	This is a dedicated function for winding applications, which is used for wiring detection. When the valid or invalid time of the wiring detection signal expires, E44 protection will be reported.
123	Brake reset terminal	This is a dedicated function for winding applications. When the brake output is valid, this terminal can be closed to reset the brake output.

Function code	Function code name	Parameter description								Unit	Default setting	Attribute
		D7	D6	D5	D4	D3	D2	D1	D0			
F02.15	Positive/negative logic 1 of digital input terminal	*	*	*	X5	X4	X3	X2	X1		00000	○
		0: positive logic is valid in the closed state/invalid in the open state 1: negative logic is valid in the closed state/invalid in the open state										
F02.16	Positive/negative logic 2 of digital input terminal	*	*	*	*	*	*	AI2	AI1		00	○
		0: positive logic is valid in the closed state/invalid in the open state 1: negative logic is valid in the closed state/invalid in the open state										

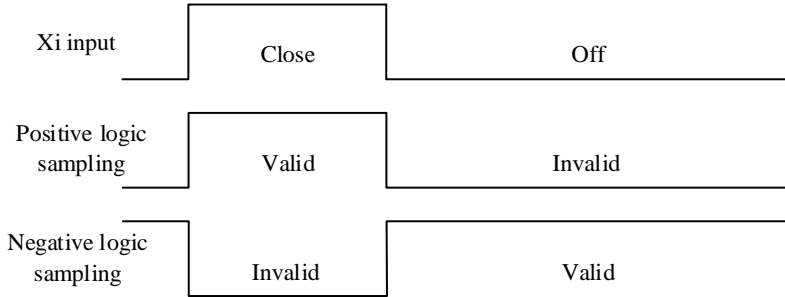

Fig. 7-12 Schematic Diagram of Positive/Negative Logic Sampling of Terminal

When the bit is set to 0, the multi-function input terminal is valid in the closed status and invalid in the open status;

When the bit is set to 1, the multi-function input terminal is valid in the open status and invalid in the closed status.

These function code are subject to bit operation. You only need to set the corresponding bit to 0 or 1. Take F02.15 as an example, as shown in the following table:

Table 7-7 Function Code Details of Bit Operation

Setting item	*	*	*	X5	X4	X3	X2	X1
Corresponding bit	*	*	*	4	3	2	1	0
Settings	*	*	*	0/1	0/1	0/1	0/1	0/1

The seventh bit is reserved and cannot be set. The specific displayed value does not mean anything.

For example: To set the terminal X1 to reverse logic, you only need to set the 0th bit corresponding to X1 to 1, i.e. F02.15=xxx xxx1.

To set the terminals X1 and X5 to reverse logic, you only need to set the 0th bit corresponding to X1 and 4th bit corresponding to X5 to 1. That is, 02.15=xxx 1xxx1.

★ This function is for logic matching with other external devices.

Function code	Function code name	Parameter description	Unit	Default setting	Attribute
F02.17	Filtering times of digital input terminal	0-100; 0: no filtering; n: sampling once in n ms		2	○

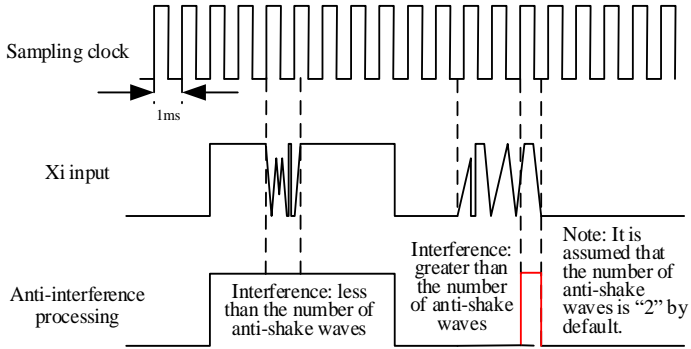

Fig. 7-13 Schematic Diagram of Terminal Filter Sampling

Since the multi-function input terminal is triggered by level or pulse, digital filtering is needed when the terminal status is read, in order to avoid interference.

- ★ The parameters of this code do not need to be adjusted under normal circumstances. Where adjustment is required, pay attention to the relationship between the filtering time and terminal action duration, to avoid the susceptibility to interference due to insufficient filtering times or slow responses and command losses arising from excessive filtering times.

Function code	Function code name	Parameter description	Unit	Default setting	Attribute
F02.18	X1 valid delay time	0.000-30.000	s	0.000	●
F02.19	X1 invalid delay time	0.000-30.000	s	0.000	●
F02.20	X2 valid delay time	0.000-30.000	s	0.000	●
F02.21	X2 invalid delay time	0.000-30.000	s	0.000	●
F02.22	X3 valid delay time	0.000-30.000	s	0.000	●
F02.23	X3 invalid delay time	0.000-30.000	s	0.000	●
F02.24	X4 valid delay time	0.000-30.000	s	0.000	●
F02.25	X4 invalid delay time	0.000-30.000	s	0.000	●

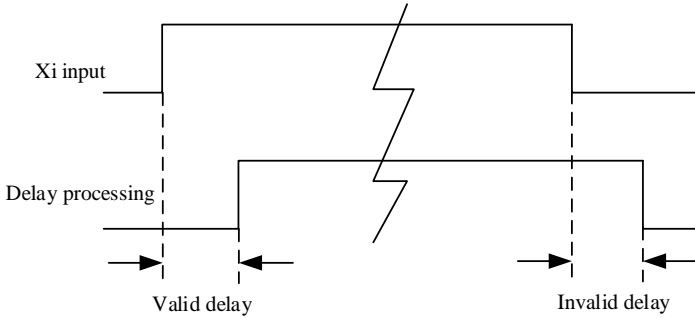

Fig. 7-14 Schematic Diagram of Terminal Delay Sampling

In the event of changes in the status of the function terminal, a response will be made with delay according to the function code settings. Currently only the terminals X1 to X4 support this function. Specifically, it is embodied in: This function will take effect when the function terminal changes from the invalid to valid status and is maintained with the valid delay, and not take effect when the function terminal changes from the valid to invalid status and is maintained with the invalid delay.

★ If the function code is set to 0.000s, the corresponding delay will be invalid.

Function code	Function code name	Parameter description	Unit	Default setting	Attribute
F02.31	Options of analog input function	Ones place: AI1 0: analog input 1: digital input (0 below 1V, 1 above 3V, the same as last time under 1-3V) Tens place: AI2 0: analog input 1: digital input (the same as above)		00D	○

The analog input terminals AI1 and AI2 of the EM730/EM730E series inverter can be used as digital input terminals. You only need to set the corresponding bit to 1. To use the AI2 terminal as a digital terminal, you only need to set F02.31=xx1x. The analog input and digital logic conversion are as follows:

- When the input voltage of the terminal is less than 1V, its corresponding logic status will be invalid;
- When the input voltage of the terminal is greater than 3V, its corresponding logic status will be valid;

- When the input voltage of the terminal is within [1V, 3V], its corresponding logic status will remain unchanged.

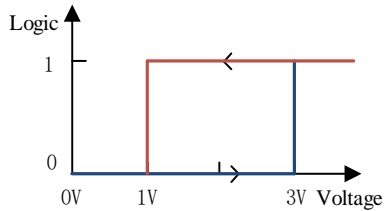

Fig. 7-10 Correspondence between Analog Input Terminal Voltage and Current Logic Status

If it is used as an analog input terminal, the filter time and corresponding offset curve can be set via F02.32 to F02.60. The terminals AI1 to AI2 can be set separately.

Function code	Function code name	Parameter description	Unit	Default setting	Attribute
F02.32	Options of analog input curve	Ones place: Options of AI1 curve 0: curve 1 1: curve 2 2: curve 3 3: curve 4 Tens place: AI2 curve selection 0: curve 1 1: curve 2 2: curve 3 3: curve 4		10D	○
F02.33	Minimum input of curve 1	0.00 - F02.35	V	0.10	●
F02.34	Minimum input setting of curve 1	-100.0 - +100.0	%	0.0	●
F02.35	Maximum input of curve 1	F02.33 - 10.00	V	9.90	●
F02.36	Maximum input setting of curve 1	-100.0 - +100.0	%	100.0	●
F02.37	Minimum input of curve 2	-10.00 - F02.39	V	0.10	●
F02.38	Minimum input setting of curve 2	-100.0 - +100.0	%	0.0	●
F02.39	Maximum input of curve 2	F02.37 - 10.00	V	9.90	●
F02.40	Maximum input setting of curve 2	-100.0 - +100.0	%	100.0	●
F02.41	Minimum input of curve 3	0.00V - F02.43	V	0.10	●

F02.42	Minimum input setting of curve 3	-100.0 - +100.0	%	0.0	●
F02.43	Input of inflection point 1 of curve 3	F02.41 - F02.45	V	2.50	●
F02.44	Input setting of inflection point 1 of curve 3	-100.0 - +100.0	%	25.0	●
F02.45	Input of inflection point 2 of curve 3	F02.43 - F02.47	V	7.50	●
F02.46	Input setting of inflection point 2 of curve 3	-100.0 - +100.0	%	75.0	●
F02.47	Maximum input of curve 3	F02.45 - 10.00	V	9.90	●
F02.48	Maximum input setting of curve 3	-100.0 - +100.0	%	100.0	●
F02.49	Minimum input of curve 4	-10.00 - F02.51	V	0.10	●
F02.50	Minimum input setting of curve 4	-100.0 - +100.0	%	0.0	●
F02.51	Input of inflection point 1 of curve 4	F02.49 - F02.53	V	2.50	●
F02.52	Input setting of inflection point 1 of curve 4	-100.0 - +100.0	%	25	●
F02.53	Input of inflection point 2 of curve 4	F02.51 - F02.55	V	7.50	●
F02.54	Input setting of inflection point 2 of curve 4	-100.0 - +100.0	%	75	●
F02.55	Maximum input of curve 4	F02.53 - 10.00	V	8.80	●
F02.56	Maximum input setting of curve 4	-100.0 - +100.0	%	100	●
F02.57	AI1 filtering time	0.00 - 10.00	s	0.10	●
F02.58	AI2 filtering time	0.00 - 10.00	s	0.10	●

F02.32 is used to select the corresponding offset curve for each analog input terminal. In total, four groups of offset curves are available. Among them, the curves 1 and 2 indicate two-point offsets, while the curves 3 and 4 indicate four-point offsets. After selecting an offset curve, you can set the corresponding function code to meet the input requirements.

The filtering time can be adjusted according to the analog input and actual working conditions. The actual effect will prevail.

Function code	Function code name	Parameter description	Unit	Default setting	Attribute
F02.61	AD sampling hysteresis	2 - 50		2	○

This function code can be increased properly in the case of analog input hysteresis, long

input lines or excessive on-site interference resulting in significant input fluctuations. In principle, this function code should be minimized.

Function code	Function code name	Parameter description	Unit	Default setting	Attribute
F02.62	Selection of analog input AI1 type	0: 0~10V 3: -10~10V 4: 0~5V		0	○
F02.63	Selection of analog input AI2 type	0: 0~10V 1: 4~20mA 2: 0~20mA 4: 0~5V		0	○

Select the input type of AI1 and AI2: current or voltage type. Determine the upper and lower limits corresponding to the range.

F02.62 =0: 0~10V

AI1 is the voltage type, with a range of 0-10V. The input voltage (0-10V) corresponds to the setting 0%-100%. 0V corresponds to 0%, and +10V corresponds to 100%.

F02.62 =3: -10~10V

AI1 is the voltage type, with a range of -10-10V. The input voltage (-10 to 10V) corresponds to the setting -100% to 100%. -10V corresponds to -100%, and +10V corresponds to 100%.

F02.62 =4: 0~5V

AI1 is the voltage type, with a range of 0-5V. The input voltage (0-5V) corresponds to the setting 0%-100%. 0V corresponds to 0%, and +5V corresponds to 100%.

F02.63 =0: 0~10V

AI2 is the voltage type, with a range of 0-10V. The input voltage (0-10V) corresponds to the setting 0%-100%. 0V corresponds to 0%, and +10V corresponds to 100%.

F02.63=1: 4-20mA (adjust the short circuit cap of the control panel to the current mode)

AI2 is the current type, with a range of 4-20mA. The input current (4-20mA) corresponds to the setting 0%-100%. The current of 4mA or less corresponds to 0%, and 20mA corresponds to 100%.

F02.63=2: 0-20mA (adjust the short circuit cap of the control panel to the current

mode)

AI2 is the current type, with a range of 0-20mA. The input current (0-20mA) corresponds to the setting 0%-100%. 0mA corresponds to 0%, and 20mA corresponds to 100%.

F02.63 =4: 0~5V

AI2 is the voltage type, with a range of 0-5V. The input voltage (0-5V) corresponds to the setting 0%-100%. 0V corresponds to 0%, and +5V corresponds to 100%.

Function code	Function code name	Parameter description	Unit	Default setting	Attribute
F02.66	Selection of AI2 current input impedance	0: 500Ω 1: 250Ω		0	○

Select the AI2 current input impedance according to the actual situation on the site. The default input impedance is 500 ohms. In case of no 20mA output due to the poor load capacity of the input current source, the input impedance can be changed to 250 ohms.

7.4 Function Parameter Group of Output Terminal of F03 Group

The standard EM730/EM730E series inverter is equipped with one multi-function digital output terminal (Y1) and one relay output terminal (R1).

Function code	Function code name	Parameter description	Unit	Default setting	Attribute
F03.00	Options of Y1 output function	See Table 7-8 Function List of Multi-function Digital Output Terminals		1	○
F03.02	Options of R1 output function			7	○

Y1 and R1 are two multi-function digital output terminals. Their functions can be defined separately by setting the function codes F03.00 to F03.02.

For example, if you define F03.02=7, the function of the R1 terminal is “inverter protection”. When the inverter is in the protection status, the output of the function terminal R1 will be valid; and when the inverter is in the normal status, the output of the function terminal R1 will be invalid. Specific options are described in Table 7-8.

Table 7-8 Function List of Multi-function Digital Output Terminals

Settings	Function	Description
0	No output	The protection terminal will be disabled or set to “0: Unavailable” to prevent incorrect output.
1	Inverter running (RUN)	The inverter is in the status of slave running, slave stop, jog running or jog stop. The current output is valid in the

		aforesaid statuses and invalid in other statuses.
2	Up to output frequency (FAR)	When the output frequency-set frequency is less than or equal to the frequency detection width (F15.20) in the running status, the current output will be valid. When the inverter is not in the running status, or the output frequency-set frequency is beyond the frequency detection width (F15.20), the current output will be invalid. See the description of the function code F15.20.
3	Output frequency detection FDT1	When the output frequency is greater than the result of output frequency detection FDT1 (F15.21) in the running status, the current output will be valid. When the inverter is not in the running status, or the output frequency is less than or equal to the result of output frequency detection FDT1 (F15.21) minus FDT1 hysteresis (F15.22), the current output will be invalid. In other statuses, the current output will remain unchanged. See the description of the function codes F15.21 and F15.22.
4	Output frequency detection FDT2	When the output frequency is greater than the result of output frequency detection FDT2 (F15.23) in the running status, the current output will be valid. When the inverter is not in the running status, or the output frequency is less than or equal to the result of output frequency detection FDT2 (F15.23) minus FDT2 hysteresis (F15.24), the current output will be invalid. In other statuses, the current output will remain unchanged. See the description of the function codes F15.23 and F15.24.
5	Reverse running (REV)	When the running direction and acceleration/deceleration of the inverter is in the status of reverse acceleration, reverse deceleration or reverse constant speed, the current output will be valid. In other statuses, the current output will be invalid.
6	Jog	When the inverter is in the status of JOG running or JOG stop, the current output will be valid. In other statuses, the current output will be invalid.
7	Inverter protection	The current output will be valid when the inverter is in the protection status and invalid when the inverter is in other statuses.
8	Inverter ready to run (READY)	When the inverter has been powered on and completely initialized without any abnormality, the current output will

		be valid. When the inverter is not suitable for running, the current output will be invalid.
9	Reach the upper frequency limit	When the inverter is in the JOG or slave running status, the output frequency (F18.00) is greater than or equal to the upper frequency limit (F00.17 F00.18), and the set frequency (F18.01) is greater than or equal to the upper frequency limit (F00.17 F00.18), the current output will be valid. Otherwise, the current output will be invalid.
10	Reach the lower frequency limit	When the inverter is in the JOG or slave running status, the output frequency (F18.00) is less than or equal to the lower frequency limit (F00.19), and the set frequency (F18.01) is less than or equal to the lower frequency limit (F00.19), the current output will be valid. Otherwise, the current output will be invalid.
11	Valid current limit	When the output current (F18.06) is greater than or equal to the current limit (F07.12), the current output will be valid; when the output current (F18.06) is less than or equal to the current limit (F07.12) -5.0%, the current output will be invalid; and when the output current is an intermediate value, the current output will remain unchanged.
12	Valid overvoltage stall	When the output voltage (F18.07) is greater than or equal to the voltage of overvoltage stall control (F07.07), the current output will be valid; when the output voltage (F18.07) is less than or equal to the voltage of overvoltage stall control (F07.07) minus 10V, the current output will be invalid; and when the output voltage is an intermediate value, the current output will remain unchanged.
13	Complete simple PLC cycle	When the simple PLC is in the mode of stop after a single operation (F18.15=0), it will be stopped after one operation and the current output will be valid; when the simple PLC is in the mode of stop after a limited number of operations (F18.15=1), it will be stopped after the operations set by F08.16, and the current output will be valid; otherwise (e.g. further running, simple PLC status resetting), the current output will be invalid.
14	Reach the set count value	When the input pulse count value (F18.34) is greater than or equal to the set count value (F16.03), the current output will be valid; otherwise, the output will be invalid. See the description of function codes F16.03 to F16.04.

15	Reach the specified count value	When the input pulse count value (F18.34) is greater than or equal to the specified count value (F16.04), the current output will be valid; otherwise, the output will be invalid. See the description of function codes F16.03 to F16.04.
16	Reach the length (in meters)	When the input pulse conversion length (F18.34) is greater than or equal to the set length (F16.01), the current output will be valid; otherwise, the output will be invalid. See the description of the function codes F16.01 to F16.02.
17	Motor overload pre-alarm	When the current motor current is greater than or equal to the motor pre-alarm coefficient (F07.02), the current output will be valid; otherwise, the current output will be invalid.
18	Inverter overheat pre-alarm	When the inverter temperature is greater than or equal to the hot spot (-10 °C), the pre-alarm output will be valid; and when the inverter temperature is less than the hot spot minus 15 °C, the pre-alarm output will be invalid (5 °C hysteresis).
19	Reach the upper limit of PID feedback	If the PID feedback (F18.17) is greater than or equal to the upper limit (F09.16) of PID output during operation, the current output will be valid; otherwise, the output will be invalid.
20	Reach the lower limit of PID feedback	If the PID feedback (F18.17) is less than or equal to the lower limit (F09.17) of PID output during operation, the current output will be valid; otherwise, the output will be invalid.
21	Analog level detection ADT1	When the selected analog channel input is greater than or equal to the result of analog level detection (F15.26/28), the corresponding output will be valid; when the selected analog channel input is less than or equal to the result of analog level detection (F15.26/28) minus hysteresis (F15.27/29), the corresponding output will be invalid; and in other statuses, the current output will remain unchanged. See the description of the function codes F15.25 to F15.29.
22	Analog level detection ADT2	
24	Undervoltage status	When the DC bus voltage (F18.08) is less than or equal to the voltage of undervoltage stall control (F07.08), the current output will be valid; when the DC bus voltage (F18.08) is greater than or equal to the voltage of power failure end judgment (F07.09), and the holding time is greater than or equal to the determined delay time of power failure end (F07.10), the current output will be invalid.

26	Up to the set time	When it reaches the regular running time, the current output will be valid; otherwise, the output will be invalid. See the description of the function code F16.09.
27	Running at zero speed	When the inverter is in the JOG or slave running status and the output frequency (F18.00) is less than or equal to the zero servo start frequency (F04.29), the current output will be valid; otherwise, the current output will be invalid.
28 - 37	Reserved	
38	Off-load	The inverter is in the off-load status.
39 - 46	Reserved	
47	PLC output	When this function is selected for the output terminal, the output of Y1 and R1 will be controlled by the corresponding bit of F03.31. If the corresponding bit is 1, the output will be valid; and if the corresponding bit is 0, the output will be invalid.
48~66	Reserved	
67	Brake control	This is a dedicated function for winding applications. When the brake is enabled, the output of this function will be valid.
68	Material cutoff detection output	This is a dedicated function for winding applications. In case of material cutoff, the output of this function will be valid.
69	FDT1 lower limit (pulse)	This is similar to #3/4 function. The difference is that the output will be valid when the frequency is lower than the "setting-hysteresis" and automatically turn invalid after some time. If the single pulse output is set, the time will be set by F03.17 to F03.20; and if the level output is enabled, the time is 0.1 s by default.
70	FDT2 lower limit (pulse)	
71	FDT1 lower limit (pulse, invalid in JOG)	This function is the same as #69/70 function, except for no output in the JOG status.
72	FDT2 lower limit (pulse, invalid in JOG)	
73	Output overcurrent	When this function of the output terminal is enabled, the current exceeds the F15.66 overcurrent detection level, and the duration reaches the value of F15.67, the output will be valid.

The Y1 multi-function output ports are of open collector output type, with YCM as the common output port. If the selected function is disabled, the electronic switch will be OFF, and

the multi-function output ports will be in the invalid status. If the selected function is enabled, the electronic switch will be ON, and the multi-function output ports will be in the valid status. The open collector can be powered on internally or by an external power supply (12-30V).

The relay output is from the internal relay of the inverter. The relay has one set of normally open contacts and one set of normally closed contacts. When the selected function is disabled, the EB-EC is normally closed and EA-EC is normally open. When the selected function is enabled, the internal relay coil will be powered on, the EB-EC will be disconnected, and the EA-EC will be engaged. See Fig. 7-12.

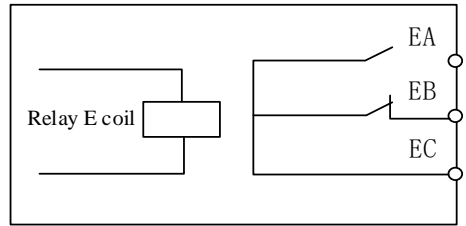

Fig. 7-12 Relay Contacts

Function code	Function code name	Parameter description								Unit	Default setting	Attribute
		D7	D6	D5	D4	D3	D2	D1	D0			
F03.05	Options of output signal type	*	*	*	*	*	R1	*	Y1		0*0	○
		0: level 1: single pulse										

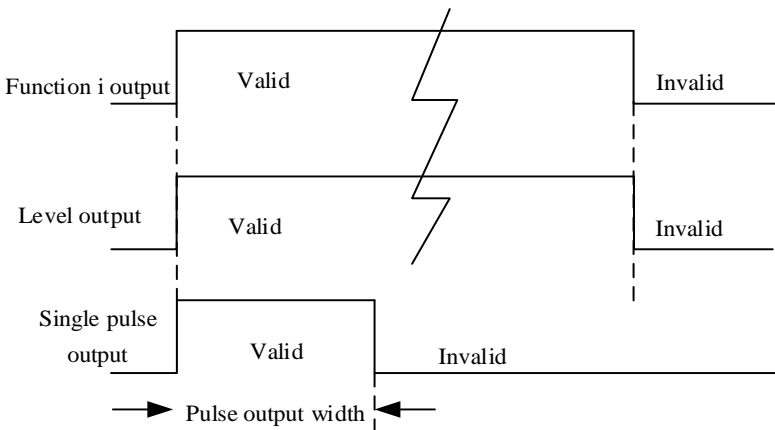

Fig. 7-13 Schematic Diagram of Level and Single Pulse Output of Digital Output Terminal

The digital output terminal Y1 and relay output terminal R1 have two output types: level and single pulse, as shown in Fig. 7-. For the level output, the output status of the function terminal is consistent with the function status; and for the single pulse output, the active level of a certain pulse width will not be outputted until the function is enabled.

This function code is subject to bit operation. For specific settings, refer to the description of the function code F02.15. Table 7-7

Function code	Function code name	Parameter description								Unit	Default setting	Attribute
F03.06	Positive/ negative logic of digital output	D7	D6	D5	D4	D3	D2	D1	D0		0*0	○
		*	*	*	*	*	R1	*	Y1			
		0: positive logic is valid in the closed state/invalid in the open state 1: negative logic is valid in the closed state/invalid in the open state										

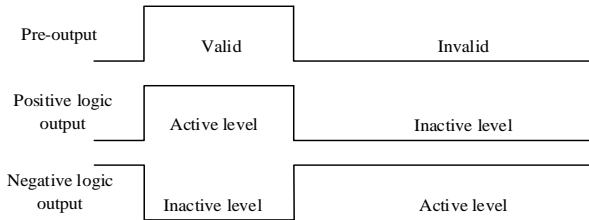

Fig. 7-14 Schematic Diagram of Positive and Negative Logic Output of Digital Output Terminal

The multi-function digital output terminal has two output logics according to the design:

0: Positive logic. When the function is enabled, the multi-function output terminal will output the active level; otherwise, the multi-function output terminal will output the inactive level.

1: Negative logic. When the function is enabled, the multi-function output terminal will output the inactive level; otherwise, the multi-function output terminal will output the active level.

This function code is subject to bit operation. For specific settings, refer to the description of the function code F02.15. Table 7-7

★ This function is for logic matching with other external devices.

Active level: Y1, low level by default; R1, high level by default.

Function code	Function code name	Parameter description								Unit	Default setting	Attribute
		D7	D6	D5	D4	D3	D2	D1	D0			
F03.08	Output status control in jog	*	*	*	REV	FDT 2	FDT 1	FAR	RUN		00000	○
		0: valid in jogging 1: invalid in jogging										

It is usually not necessary for DO to output certain statuses during jog running. The corresponding output can be shielded by setting the corresponding bit of this function code to 1. If F03.08=xxx1x is set and the FAR output is valid, the actually selected output terminal will not output the active level.

This function code is subject to bit operation. For specific settings, refer to the description of the function code F02.15. Table 7-7

Function code	Function code name	Parameter description	Unit	Default setting	Attribute
F03.09	Y1 valid delay time	0.000-30.000	s	0.000	●
F03.10	Y1 invalid delay time	0.000-30.000	s	0.000	●
F03.13	R1 valid delay time	0.000-30.000	s	0.000	●
F03.14	R1 invalid delay time	0.000-30.000	s	0.000	●

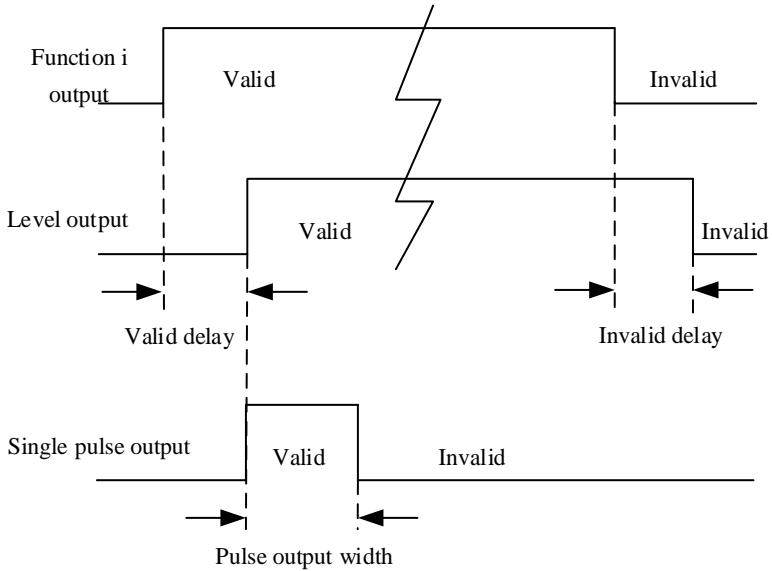

Fig. 7-15 Schematic Diagram of Level and Single Pulse Output of Digital Output Terminal

When the status of the selected function changes, the corresponding output terminal will make a response with delay based on the function code settings. At present, the terminals Y1 and R1 support this function. Details under default conditions: When the function changes from the invalid to valid status and is maintained with the valid delay, the corresponding output terminal will output the active level. When the function changes from the valid to invalid status and is maintained with the invalid delay, the corresponding output terminal will output the inactive level.

★ If the function code is set to 0.000s, the delay will be invalid.

Function code	Function code name	Parameter description	Unit	Default setting	Attribute
F03.17	Single pulse time of Y1 output	0.001 - 30.000	s	0.250	●
F03.19	Single pulse time of R1 output	0.001 - 30.000	s	0.250	●

When one function output terminal is in the single pulse output mode (see F03.05 for details), the pulse width of the active level can be controlled by setting the single pulse output time, in order to meet different process or control requirements. Details are given in Fig. 7- and

Fig. 7-

Function code	Function code name	Parameter description	Unit	Default setting	Attribute
F03.21	Options of analog output M1	See Table 7-9 Function List of Multi-function Analog Output Terminal		0	○

M1 is a multi-function analog output terminal. Its functions can be defined separately by setting the value of the function code F03.21.

For example, if F03.21=0 is defined, the function of the M1 terminal is to output the “operating frequency (absolute value)”. The current |operating frequency| is reflected by the output voltage. If the operating frequency increases from 0.00Hz to 50.00Hz (assuming F00.16=50.00), the voltage of the M1 output port will increase from 0.00V to 10.00V under the default conditions, showing the same change trend. Specific options are described in Table 7-9.

Table 7-9 Function List of Multi-function Analog Output Terminal

Settings	Function	Description
0	Operating frequency (absolute value)	0.00Hz to Fmax, corresponding to the output 0.0% to 100.0%
1	Set frequency (absolute value)	0.00Hz to Fmax, corresponding to the output 0.0% to 100.0%
2	Output torque (absolute value)	0.0% to 200.0%, corresponding to the output 0.0% to 100.0%
3	Set torque (absolute value)	0.0% to 200.0%, corresponding to the output 0.0% to 100.0%
4	Output current	0.0A to 2*Ie, corresponding to the output 0.0% to 100.0%
5	Output voltage	0.0V to 1.5*Ue, corresponding to the output 0.0% to 100.0%
6	Bus voltage	0V to about 2.63*Ue, corresponding to the output 0.0% to 100.0% (That is, for the 220V driver, 579V corresponds to the output 100.0%; and for the 380V driver, 1000V corresponds to the output 100.0%. Drivers at different voltage levels have the same output voltage at their rated voltages.)

7	Output power	0.00kW to 2*Pe, corresponding to the output 0.0% to 100.0%
8	AI1	Output the actual input voltage, instead of the offset result. 0.0% to 100.0%, corresponding to the output 0.0% to 100.0%
9	AI2	
12	High-frequency pulse input (with 100% corresponding to 100.00kHz)	The function codes F02.26-F02.28 correspond to the output 0.0%-100.0%.
13	Communication setting 1	Communication setting by M1 terminal, communication address option 701AH
14	Count value	0 to F16.03, corresponding to the output F16.10 to F16.11
15	Length value	0 to F16.01, corresponding to the output F16.10 to F16.11
16	PID output percentage	-100.0% to 100.0%, corresponding to the output 0.0% to 100.0%
18	PID feedback	-100.0% to 100.0%, corresponding to the output 0.0% to 100.0%
19	PID setting	-100.0% to 100.0%, corresponding to the output 0.0% to 100.0%

★ Fmax, maximum frequency (F00.16)

Ie, rated current of the inverter (F12.21)

Ue, rated voltage of the inverter (F12.20)

Pe, rated power of the inverter (F12.19)

The output physical quantity of the analog output terminal can be switched between the voltage signal (0.00V to 10.00V) and current signal (0.00mA to 20.00mA) via the jumper cap. For the voltage signal output, the value from 0.0% to 100.0% corresponds to the output 0.00V to 10.00V. For the current signal output, the value from 0.0% to 100.0% corresponds to the output 0.00mA to 20.00mA.

Function code	Function code name	Parameter description	Unit	Default setting	Attribute
F03.27	M1 output bias	-100.0 - 100.0	%	0.0	●
F03.28	M1 output gain	-10.00 - 10.00		1.00	●

The above function codes are usually used to correct the zero drift of analog output and the deviation of output amplitude. They can also be used to customize the required AO output curve to meet the requirements of different instruments or others. If the offset is represented by “b”,

the gain by “k”, actual output by “Y” and standard output by “X”, the actual output is: $Y=kX + b$.



1. In order to meet the needs of different instruments or external devices, the full-scale voltage of M1 is actually 10.9V and the full-scale current is actually 22mA.
2. The default setting of M1 is 0.00-10.00V.
3. Where there are high precision requirements for the analog output during operation, test the no-load outputs of the terminals M1 with a multimeter first.

Function code	Function code name	Parameter description							Unit	Default setting	Attribute	
F03.31	Control logic options of PLC output terminal	D7	D6	D5	D4	D3	D2	D1	D0		0*0	●
		*	*	*	*	*	R1	*	Y1			
		0: no output 1: Output										

When the output functions of Y1 and R1 are set to “47: PLC output”, the output result will be controlled by the corresponding bit of F03.31. 0 indicates no output and 1 indicates that there is output.

Function code	Function code name	Parameter description	Unit	Default setting	Attribute
F03.34	Output type options of analog output M1	0: 0~10V 1: 4~20mA 2: 0~20mA		0	○

The output type of M1 is controlled by F03.34, and the corresponding short-circuit cap of the control panel M1 needs to be set correctly according to the output voltage or current:

F03.34=0: output voltage 0-10V

F03.34=1: output current 4-20mA

F03.34=2: output current 0-20mA

7.5 Start/Stop Control Parameter Group of F04 Group

Function code	Function code name	Parameter description	Unit	Default setting	Attribute
F04.00	Start-up method	0: direct start 1: start of speed tracking		0	○

F04.00=0: direct start

The inverter is started at the starting frequency, following the DC braking (not suitable when F04.04=0) and pre-excitation (not suitable when F04.07=0). The starting frequency will change to the set frequency after the holding time.

F04.00=1: start with speed tracking

The inverter is smoothly started from the current rotation frequency of the motor, following the speed tracking (size and direction).

Function code	Function code name	Parameter description	Unit	Default setting	Attribute
F04.01	Start frequency	0.00 - 10.00	Hz	0.00	○
F04.02	Start frequency hold time	0.00-60.00, 0.00 is invalid	s	0.00	○

In order to ensure the motor torque during the start, please set the appropriate starting frequency. To fully establish the magnetic flux during the motor start, the starting frequency should be maintained for some time. The starting frequency F04.01 is not limited by the lower frequency limit.

Function code	Function code name	Parameter description	Unit	Default setting	Attribute
F04.03	Starting current of DC braking	0.0~100.0 (100.0 = Rated current of motor)	%	100.0	○
F04.04	Starting time of DC braking	0.00 - 30.00	s	0.00	○

Before the inverter is started, the motor may be in the status of low-speed running or reverse rotation. If the inverter is started immediately, it may be subject to overcurrent protection. In order to avoid such protections, it is necessary to perform DC braking to stop the motor and then make the motor run in the set direction to the set frequency before the inverter is started.

When F04.03 is set to different values, DC braking torques can be enabled.

F04.04 is used to set the time to enable DC braking. The inverter will start running once the set time is up. If F04.04=0.00, DC braking is invalid during start.

★ DC braking is started as shown in Fig. 7-.



When multiple motors are driven by a single inverter, this function can be applied.

Function code	Function code name	Parameter description	Unit	Default setting	Attribute
F04.06	Pre-excitation current	50.0-500.0 (100.0 = no-load current)	%	100.0	○
F04.07	Pre-excitation time	0.00 - 10.00	s	0.10	○

The inverter will start running after the magnetic field is established according to the set pre-excitation current F04.06 and the set pre-excitation time F04.07 is up. If the pre-excitation time is set to 0, the inverter will be started directly without pre-excitation.

The pre-excitation current F04.06 is the percentage relative to the rated no-load current of the motor.

Function code	Function code name	Parameter description	Unit	Default setting	Attribute
F04.08	Speed tracking mode	Ones place: Tracking start frequency 0: maximum frequency 1: stop frequency 2: power frequency Tens place: Selection of search direction 0: search only in command direction 1: Search in the opposite direction if the speed cannot be found in the command direction		0	○

When the speed tracking start mode (F04.00=1) is selected, the inverter will be subject to speed tracking according to the setting of F04.08 during the start. For quicker tracking to the current operating frequency of the motor, please select the appropriate mode based on the working conditions.

If the units place of F04.08 is 0, tracking will be performed from the maximum frequency. This can be applied when the operating conditions of the motor are completely uncertain (for example, the motor is already rotating when the inverter is powered on).

If the units place of F04.08 is 1, tracking will be performed from the stop frequency. This mode is usually applied.

If the units place of F04.08 is 2, tracking will be performed from the power frequency. This mode can be applied during switching from the power frequency.

If the tens place of F04.08 is 0, search will be performed only in the command direction after speed tracking is enabled. In case that the corresponding speed is not found, the inverter will start running from the zero speed.

If the tens place of F04.08 is 1, search will be performed first in the command direction after speed tracking is enabled and then in the opposite direction if no speed is found.

Function code	Function code name	Parameter description	Unit	Default setting	Attribute
F04.10	Deceleration time of speed tracking	0.1 - 20.0	s	2.0	○
F04.11	Speed tracking current	30.0-150.0 (100.0 = rated current of inverter)	%	50.0	○
F04.12	Speed tracking compensation gain	0.00 - 10.00		1.00	○

F04.10: scanning speed for speed tracking from the predetermined frequency. The duration is the time for the rated frequency to decrease to 0.00Hz.

F04.11: current tracking, ratio to the rated current of the inverter. The lower the current, the less the impact on the motor is, and the higher the tracking accuracy is. If the set value is too small, the tracking result may be inaccurate, causing failure in start. The higher the current, the less the motor speed drops. This value should be increased during heavy-load tracking.

F04.12: tracking intensity, usually taking the default value. When the tracking speed is high and the overvoltage protection is enabled, you can try to increase this value.

Function code	Function code name	Parameter description	Unit	Default setting	Attribute
F04.14	Acceleration and deceleration mode	0: linear acceleration and deceleration 1: acceleration and deceleration of continuous S curve 2: acceleration and deceleration of intermittent S curve		0	○
F04.15	Starting time of S curve in acceleration	0.00 to system acceleration time/2 (F15.13=0) 0.0 to system acceleration time/2 (F15.13=1) 0 to system acceleration time/2	s	1.00	●

		(F15.13=2)			
F04.16	Ending time of S curve in acceleration	0.00 to system acceleration time/2 (F15.13=0) 0.0 to system acceleration time/2 (F15.13=1) 0 to system acceleration time/2 (F15.13=2)	s	1.00	●
F04.17	Starting time of S curve in deceleration	0.00 to system deceleration time/2 (F15.13=0) 0.0 to system deceleration time/2 (F15.13=1) 0 to system deceleration time/2 (F15.13=2)	s	1.00	●
F04.18	Ending time of S curve in deceleration	0.00 to system deceleration time/2 (F15.13=0) 0.0 to system deceleration time/2 (F15.13=1) 0 to system deceleration time/2 (F15.13=2)	s	1.00	●

F04.14=0: linear acceleration and deceleration

The output frequency increases or decreases linearly. The acceleration and deceleration time is set by the function codes F00.14 and F00.15 by default.

F04.14=1: continuous S-curve acceleration and deceleration

The output frequency increases or decreases according to the curve. The S curve is usually where there are relatively low requirements for start and stop, such as elevators and conveyor belts. In the acceleration process shown in Fig. 7–16, t1 is the set value of F04.15, and t2 is the set value of F04.16. In the deceleration process, t3 is the set value of F04.17, and t4 is the set value of F04.18. The slope of the output frequency remains unchanged between t1 and t2 as well as between t3 and t4.

F04.14=2: intermittent S-curve acceleration and deceleration

Compared with the continuous S-curve, the intermittent S-curve will not be over-tuned. The current S-curve trend will be stopped immediately according to changes in the settings and acceleration/deceleration time, and the new planned S-curve trend will be applied.

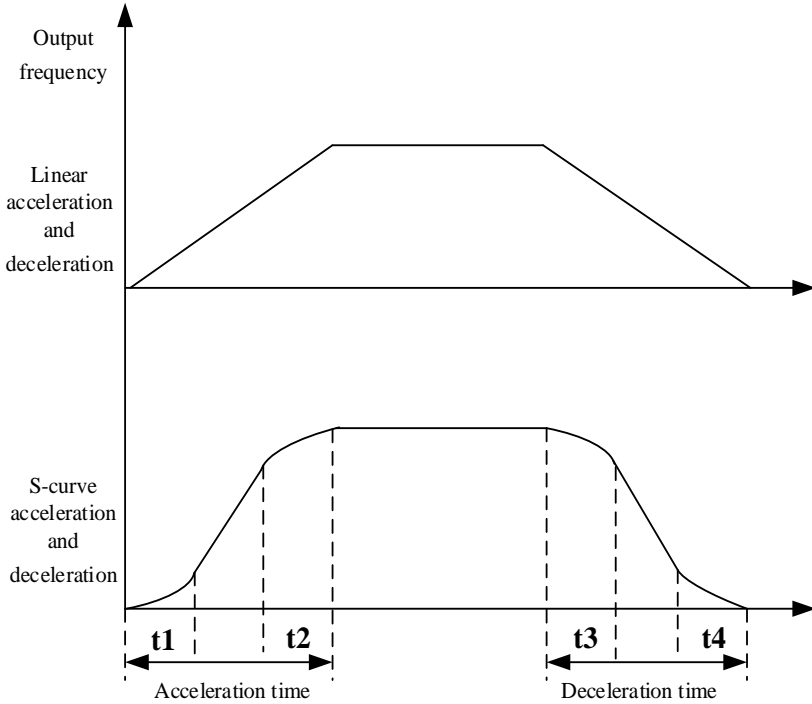

Fig. 7-16 Acceleration/Deceleration Time Control Diagram

Function code	Function code name	Parameter description	Unit	Default setting	Attribute
F04.19	Stop mode	0: slow down to stop 1: Free stop		0	○

F04.19=0: deceleration to stop

The motor decelerates to stop according to the set deceleration time [default setting: based on F00.15 (deceleration time 1)].

F04.19=1: free stop

When the stop command is valid, the inverter will stop output immediately, and the motor will freely coast to stop. The stop time depends on the inertia of the motor and load.

If the free stop terminal has been set and enabled, the inverter will be immediately in the free stop status. Even if this terminal is disabled, the inverter will not restart running. Instead, the running command must be entered again to start the inverter.

Function code	Function code name	Parameter description	Unit	Default setting	Attribute
F04.20	Starting frequency of DC braking in stop	0.00 to maximum frequency F00.16	Hz	0.00	○
F04.21	DC braking current in stop	0.0 to 150.0 (100.0 = rated current of motor)	%	100.0	○
F04.22	DC braking time in stop	0.00~30.00 0.00: invalid	s	0.00	○
F04.23	Demagnetization time for DC braking in stop	0.00 - 30.00	s	0.50	○

F04.20: Set the starting frequency of DC braking in deceleration to stop. Once the output frequency is less than the set frequency during deceleration stop, and the time of DC braking for stop is not 0, DC braking for stop will be enabled.

F04.21: Set different values to apply the torques of DC braking for stop.

F04.22: Set the duration of DC braking for stop. If F04.22=0.00, DC braking for stop will be invalid. When an external terminal sends a signal of DC braking for stop, the duration of DC braking for stop will be larger of the valid time of the signal of DC braking for stop from the external terminal and the set time of F04.22.

F04.23: When the output frequency reaches the set value of F04.20 during deceleration to stop, and the set time of F04.23 is up, DC braking will be enabled.

The process of DC braking for stop is shown in Fig. 7-.

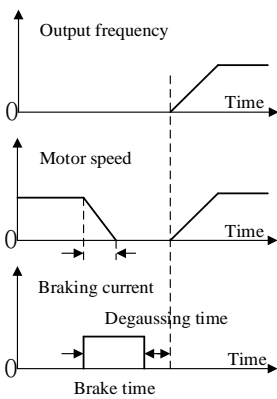

Fig. 7-17 DC Braking Process for Start

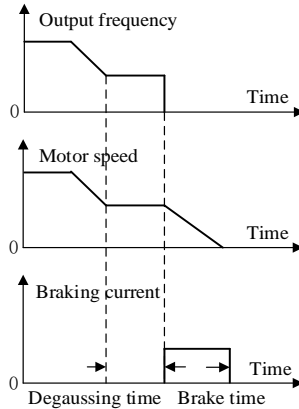

Fig. 7-18 DC Braking Process for Stop



In the presence of heavy loads, the motor cannot be stopped completely through normal deceleration due to inertia. You can extend the duration of DC braking for stop or increase the current of DC braking for stop to stop the motor from rotating.

Function code	Function code name	Parameter description	Unit	Leave-factory value	Attribute
F04.24	Flux braking gain	100-150 (100: no flux braking)		100	○

When the magnetic flux braking is valid (F04.24>100), the motor can be quickly slowed down by increasing its magnetic flux, and the electric energy can be converted into thermal energy during motor braking.

Flux braking may lead to quick deceleration, but the output current may be high. The flux braking intensity (F04.24) can be set restriction and protection to avoid damage to the motor. If flux braking is not applied, the deceleration time will be extended but the output current will be low.

Function code	Function code name	Parameter description	Unit	Default setting	Attribute
F04.26	Start mode after protection/free stop	0: start according to F04.00 setting mode 1: start of speed tracking		0	○

The start after the protection or free stop may be enabled by default according to the F04.00

setting (F04.26=0), or set to the speed tracking start (F04.26=1). For the stop mode, see the description of the function code F04.00.

Function code	Function code name	Parameter description	Unit	Default setting	Attribute
F04.27	Second confirmation of terminal start command	0: Not required for confirmation 1: to be confirmed		0	○

F04.27=0: not confirmed

The running terminal (RUN or F/R) is closed, F00.03 is set to 0 or 1, and the terminal is powered on during start/stop or directly run once enabled by switching the start/stop mode.

F04.27=1: confirmed

The running terminal is closed, F00.03 is set to 0 or 1, and the terminal is powered on during start/stop or cannot directly run once enabled by switching the start/stop mode. It is necessary to first disconnect the running terminal and then close it to start running.

Function code	Function code name	Parameter description	Unit	Default setting	Attribute
F04.29	Zero speed check frequency	0.00 - 5.00	Hz	0.25	●

When the output frequency is lower than the zero speed judgment frequency, the terminal “zero-speed running” will be valid.

Function code	Function code name	Parameter description	Unit	Default setting	Attribute
F04.30	Initial position search after power-on or protection	0: Invalid 1: valid		1	●

When the synchronous motor is used (e.g. F01.00=2) and subjected to VF control, the initial angle is essential for the control performance. In particular, reversing may occur at the moment of start. Thus, the initial position is searched by default after power-on or protection, in order to achieve a better control performance.

7.6 VF Control Parameter Group of F05 Group

The function codes in this group are valid for V/F control and invalid for vector control.

V/F control is suitable for general-purpose loads such as fans and pumps, or when multiple motors are driven by one inverter or the power of the inverter is quite different from that of the

motor.

Function code	Function code name	Parameter description	Unit	Default setting	Attribute
F05.00	V/F curve setting	0: straight line V/F 1: multi-point broken line V/F 2: 1.3-power V/F 3: 1.7-power V/F 4: square V/F 5: VF complete separation mode (Ud = 0, Uq = K * t = voltage of separation voltage source) 6: VF semi-separation mode (Ud = 0, Uq = K * t = F/Fe * 2 * voltage of separation voltage source)		0	○

F05.00=0: linear V/F

It is suitable for ordinary constant-torque loads.

F05.00=1: multi-point V/F

It is suitable for special loads such as dehydrators, centrifuges and cranes. Any V/F relationship curve can be obtained by setting the parameters F05.01 to F05.06.

F05.00=2/3: 1.3th power/1.7th power of V/F

It is a VF curve between the linear VF and square VF.

F05.00=4: square V/F

It is suitable for centrifugal loads such as fans and pumps.

F05.00=5: VF complete separation mode

In this case, the output frequency and output voltage of the inverter are independent of each other. The output frequency depends on the frequency source, and the output voltage is determined by F05.07 (VF separation voltage source).

The VF complete separation mode is usually applied in induction heating, inverter power supply, torque motor control, etc.

F05.00=6: VF semi-separation mode

In this case, V and F are proportional, but their proportional relationship can be set by the voltage source F05.07. In addition, the relationship between V and F is also related to the rated voltage and rated frequency of the motor in the F1 group.

Assuming that the voltage source input is X (X is 0 to 100%), the relationship between the output voltage V and frequency F of the inverter is:

$$V/F=2*X*(\text{rated voltage of the motor})/(\text{rated frequency of the motor})$$

Function code	Function code name	Parameter description	Unit	Default setting	Attribute
F05.01	Frequency point F1 of multi-point VF	0.00 - F05.03	Hz	0.50	●
F05.02	Voltage point V1 of multi-point VF	0.0~100.0 (100.0 = Rated voltage)	%	1.0	●
F05.03	Frequency point F2 of multi-point VF	F05.01 ~ F05.05	Hz	2.00	●
F05.04	Voltage point V2 of multi-point VF	0.0-100.0	%	4.0	●
F05.05	Frequency point F3 of multi-point VF	F05.03 to rated frequency of motor (reference frequency)	Hz	5.00	●
F05.06	Voltage point V3 of multi-point VF	0.0-100.0	%	10.0	●

The code parameters F05.01 to F05.06 are valid when the multi-point polyline VF is selected (F05.00=1).

All V/F curves are dependent on the curve set by the percentage of input frequency and the percentage of output voltage, linearized in sections within different input ranges.

The rated frequency of the motor is the final frequency of the V/F curve, and also the frequency corresponding to the highest output voltage. Percentage of the input frequency: rated frequency of the motor = 100.0%; percentage of the output voltage: rated voltage U_e of the motor = 100.0%.

The relationships of the three voltage points and frequency points must meet the following requirements: $V1 < V2 < V3$, $F1 < F2 < F3$;



If the slope of the V/F curve is too large, the “overcurrent” protection may be enabled. Particularly, if the low-frequency voltage is too high, the motor may be overheated and even burnt, and the inverter may be subject to overcurrent stall or overcurrent protection.

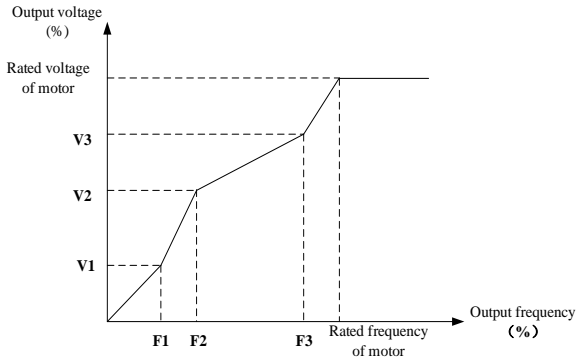

Fig. 7-19 Schematic Diagram of Multi-point Polyline V/F Curve

Function code	Function code name	Parameter description	Unit	Default setting	Attribute
F05.07	Voltage source of VF separation mode	0: digital setting of VF separation voltage 1: AI1 2: AI2 3: retention 4: High-frequency pulse (X5) 5: PID 6: Communication setting Note: 100% is the rated voltage of the motor.		0	○
F05.08	Digital setting of VF separation voltage	0.0 to 100.0 (100.0=Rated voltage of motor)	%	0.0	●

VF separation is usually applied in induction heating, inverter power supply, torque motor control, etc.

When VF separation control is selected, the output voltage can be set by the function code F05.08 or according to the analog, high-speed pulse, PID or communication settings. For non-digital settings, 100% of each setting corresponds to the rated voltage of the motor. When the percentage set by the analog output is negative, the set absolute value will be taken as the valid set value.

F05.07=0: digital setting of VF separation voltage (F05.08)

The VF separation output voltage depends on the digital setting of VF separation voltage (F05.08).

F05.07=1:AI1

F05.07=2:AI2

F05.07=4: High-frequency pulse (X5)

The VF separation output voltage depends on AI/HDI (percentage) * F05.08 (digital setting of VF separation voltage).

For the details of AI1-AI2 and X5, refer to the F00.04 description. They have the same meaning. 100.00% is the percentage to the set value of F05.08 (digital setting of VF separation voltage).

F05.07=5: process PID

The VF separation output voltage depends on the process PID function output, as described in 7.10.

F05.07=6: communication setting

The VF separation output voltage depends on the communication.

- If the master-slave communication (F10.05=1) is enabled and the inverter works as the slave (F10.06=0), the VF separation output voltage is “700FH (master-slave communication setting) * F01.02 or others (rated voltage of the motor) * F10.08 (slave receiving proportional coefficient)”. The 700FH data range is 0.00% to 100.00%, as detailed in Table 12-31.
- For general communication (F10.05=0), the VF separation output voltage is “7006H (voltage setting of the VF separation mode) * F05.08 (digital setting of the VF separation voltage)”, and the 7006H data range is 0.00% to 100.00%, as detailed in Table 12-31.

Function code	Function code name	Parameter description	Unit	Default setting	Attribute
F05.09	Rise time of VF separation voltage	0.00 - 60.00	s	2.00	●

The rise time of VF separation voltage refers to the time for the output voltage to increase from 0 to the rated voltage of the motor.

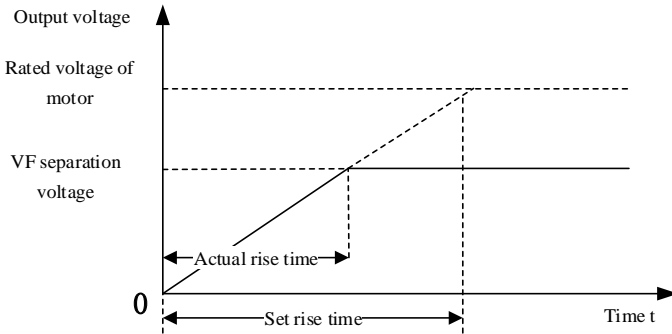

Fig. 7-20 Rise Time Description of VF Separation Voltage

Function code	Function code name	Parameter description	Unit	Default setting	Attribute
F05.10	Compensation gain of V/F stator voltage drop	0.00 - 200.00	%	100.00	●

It is used to compensate for the voltage drop caused by the stator resistor and wire, and improve the low-frequency load capacity.

Function code	Function code name	Parameter description	Unit	Default setting	Attribute
F05.11	V/F slip compensation gain	0.00 - 200.00	%	100.00	●
F05.12	V/F slip filtering time	0.00 - 10.00	s	1.00	●

As the load increases, the rotor speed of the motor will decrease. To make the rotor speed of the motor close to the synchronous speed under rated load, slip compensation can be enabled. When the motor speed is less than the target value, the set value of F05.11 can be increased.

★: In the case of F05.11=0, slip compensation is invalid. This parameter is valid only for the asynchronous motor.

The slip is 100% during the quick start with large inertia and 0 when the frequency reaches the set value. Quick increase or decrease of the output frequency will cause overvoltage or overcurrent. F05.12 filtering can slow down the rise of voltage and current.

Function code	Function code name	Parameter description	Unit	Default setting	Attribute
F05.13	Oscillation suppression gain	0 - 20000		100	●
F05.14	Oscillation	0.00-600.00	Hz	55.00	●

	suppression cutoff frequency				
--	------------------------------	--	--	--	--

This parameter can be adjusted to suppress motor oscillations during the open loop control (VVF). When the motor does not oscillate, this parameter should not be adjusted as little as possible or properly reduced. If the motor oscillates obviously, this parameter can be increased properly.

Function code	Function code name	Parameter description	Unit	Default setting	Attribute
F05.15	Droop control frequency	0.00 - 10.00	Hz	0.00	●

This function is usually applied for load distribution when one load is driven by multiple motors.

Droop control is to reduce the output frequency of the inverter with the load increasing, so that the output frequency of the motor drops more in the load driven by multiple motors, thus reducing the load on this motor and leading to even distribution of the load on multiple motors.

This parameter refers to the output frequency drop of the inverter under the rated load.

Function code	Function code name	Parameter description	Unit	Default setting	Attribute
F05.16	Energy saving rate	0.00 - 50.00	%	0.00	●
F05.17	Energy saving action time	1.00 - 60.00	s	5.00	●

The energy saving rate (F05.16) reflects the energy saving capacity. The larger the set value, the more energy will be saved. If the set value is 0.00, energy saving will be invalid.

When energy-saving operation is valid, energy saving control will be enabled once the energy saving conditions are met and have been maintained for the energy saving time (F05.17).

The default settings of the VF control optimization parameters of the synchronous motor are used under normal circumstances.

On the basis of the VF separation voltage source setting, the set value of F05.20 changes at intervals of one minute in the power supply setting.

7.7 Vector Control Parameter Group of F06 Group

Function code	Function code name	Parameter description	Unit	Default setting	Attribute
F06.00	Speed proportional gain	0.00-100.00		12.00	●

	ASR_P1				
F06.01	Speed integral time constant ASR_T1	0.000 - 30.000, 0.000: no integral	s	0.200	●
F06.02	Speed proportional gain ASR_P2	0.00-100.00		8.00	●
F06.03	Speed integral time constant ASR_T2	0.000 - 30.000, 0.000: no integral	s	0.300	●
F06.04	Switching frequency 1	0.00 to switching frequency 2	Hz	5.00	●
F06.05	Switching frequency 2	Switching frequency 1 to maximum frequency F00.16	Hz	10.00	●

In the vector control mode, the dynamic speed response of the inverter is adjusted by changing the speed proportional gain (ASR_P) and speed integral time (ASR_T) of the speed PI regulator. The increase in ASR_P or decrease in ASR_T may accelerate the dynamic response of the speed loop. If ASR_P is too large or ASR_T is too small, however, the system may be over-tuned to cause oscillation.

Users should adjust the above speed PI parameters according to the actual load characteristics. Generally, as long as the system does not oscillate, ASR_P should be increased as much as possible, and then ASR_T should be adjusted, so that the system makes response fast, without excessive over-tuning.

To enable fast dynamic responses of the system at low and high speeds, PI regulation should be performed separately at low and high speeds. During the actual operation, the speed regulator will automatically calculate the current PI parameters based on the current frequency. The speed PI parameters are P1 and T1 at the switching frequency 1, and P2 and T2 at the switching frequency 2. If the frequency is greater than the F06.04 switching frequency 1 and less than F06.05 switching frequency 2, the switching frequency 1 and switching frequency 2 will be subject to linear transition. See Fig. 7-.

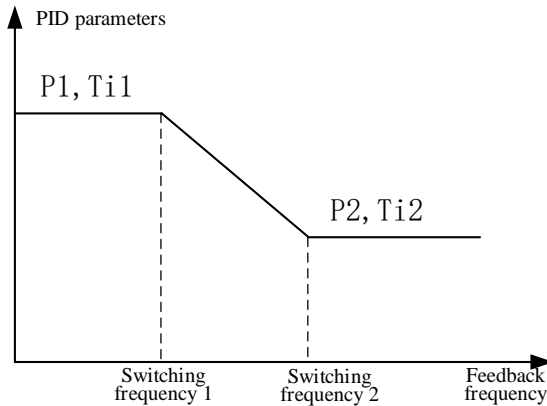

Fig. 7-21 Schematic Diagram of PI Parameters



1. The parameters F06.00 to F06.05 need to be adjusted carefully. They should not be adjusted under normal circumstances.
2. While setting the switching frequency, note that the F06.04 switching frequency 1 must be less than or equal to the F06.05 switching frequency 2.

Function code	Function code name	Parameter description	Unit	Default setting	Attribute
F06.07	Filtering time constant of speed loop output	0.000 - 0.100	s	0.001	●

Speed loop output filtering can reduce the impact on the current loop, but the value of F06.07 should not be too large. Otherwise, slow responses may be caused. Use the default settings under normal circumstances.

Function code	Function code name	Parameter description	Unit	Default setting	Attribute
F06.08	Vector control slip gain	50.00-200.00	%	100.00	●

As the load increases, the rotor speed of the motor will increase. To make the rotor speed close to the synchronous speed under the rated load, slip compensation can be enabled. When the motor speed is less than the target value, the set value of F06.08 can be increased.

For the speed sensorless vector control, this parameter can be used to adjust the speed accuracy of the motor. Increase this parameter if the motor speed is low under load, and vice

versa.

Function code	Function code name	Parameter description	Unit	Default setting	Attribute
F06.09	Upper limit source selection of speed control torque	0: set by F06.10 and F06.11 1: AI1 2: AI2 5: Communication setting (percentage) 6: the larger of AI1 and AI2 7: The smaller of AI1 and AI2		0	○
F06.10	Upper limit of speed control motor torque	0.0 - 250.0	%	165.0	●
F06.11	Upper limit of speed control brake torque	0.0 - 250.0	%	165.0	●

Vector control is used to set the operating conditions of the torque limit. If the output torque of the inverter is greater than the set upper limit, the torque limit function will be enabled, thus controlling the output torque not to exceed the upper limit of speed control torque.

F06.09=0: depending on F06.10 and F06.11

The upper limit of electric torque is F06.10, and that of braking torque is F06.11.

F06.09=1:AI1

F06.09=2:AI2

The upper torque limit is dependent on AI (percentage) * F06.10/F06.11.

For the details of AI1 and AI2, refer to the F00.04 description. They have the same meaning. 100.00% is the percentage to the set value of F06.10/F06.11.

F06.09=5: communication setting

The upper torque limit depends on the communication.

- If the master-slave communication (F10.05=1) is enabled and the inverter works as the slave (F10.06=0), the upper torque limit is “700FH (master-slave communication setting) * 250.0% * F10.08 (slave receiving proportional coefficient)”, and the 700FH data range is 0.00% to 100.00%.
- For the general communication (F10.05=0), the upper torque limit is “7019H (communication setting of the upper torque limit for speed control) * F06.10/F06.11”, and the 7019H data range is 0.0 to 250.0%.

F06.09=6: the larger of AI1 and AI2

The formula for torque upper limit calculation is the same as described above, except that the percentage of AI is the larger of AI1 and AI2.

F06.09=7: the smaller of AI1 and AI2

The formula for torque upper limit calculation is the same as described above, except that the percentage of AI is the smaller of AI1 and AI2.

	<p>1. This code parameter represents the ratio of the output torque in the torque limit action to the rated output torque of the inverter.</p> <p>2. The user can set the upper torque limit according to the actual needs, to protect the motor or meet the working conditions.</p> <p>3. The electric mode and braking mode are set separately.</p>
---	---

Function code	Function code name	Parameter description	Unit	Default setting	Attribute
F06.12	Excitation current proportional gain ACR-P1	0.00-100.00		0.50	●
F06.13	Excitation current integral time constant ACR-T1	0.0.00 - 600.00 0.00: no integral	ms	10.00	●
F06.14	Torque current proportional gain ACR-P2	0.00-100.00		0.50	●
F06.15	Torque current integral time constant ACR-T2	0.0.00 - 600.00 0.00: no integral	ms	10.00	●

The parameters of the current loop PID regulator directly affect the performance and stability of the system. The user does not need to change the default settings under normal circumstances.

Function code	Function code name	Parameter description	Unit	Default setting	Attribute
F06.17	SVC zero-frequency processing	0: braking 1: not processed 2: seal the tube		2	○
F06.18	SVC zero-frequency braking current	50.0-400.0 (100.0 is the no-load current of the motor)	%	100.0	○

In the case of SVC control (e.g. F00.01=1) and zero-frequency operation, the inverter will work according to the F06.17 setting.

F06.17=0: braking by the set current of F06.18 for zero servo operation;

F06.17=1: no processing;

F06.17=2: the inverter freely stop running with its output blocked.

Function code	Function code name	Parameter description	Unit	Default setting	Attribute
F06.20	Voltage feedforward gain	0 - 100	%	0	●

In the vector control mode, voltage feedforward adjustment is added to automatically increase the torque, i.e. the compensation for stator voltage drop.

Function code	Function code name	Parameter description	Unit	Default setting	Attribute
F06.21	Flux weakening control options	0: Invalid 1: direct calculation 2: automatic adjustment		2	○
F06.22	Flux weakening voltage	70.00-100.00	%	100.00	●
F06.23	Maximum flux weakening current of synchronous motor	0.0-150.0 (100.0 is the rated current of the motor)	%	100.0	●
F06.24	Proportional gain of flux weakening regulator	0.00 - 10.00		0.50	●
F06.25	Integral time of flux weakening regulator	0.01 - 60.00	s	2.00	●

The synchronous motor is subject to flux weakening control.

F06.21 Ones place=0, invalid

Flux weakening control is not performed. The maximum speed of the motor is related to the bus voltage of the inverter. When the maximum speed of the motor does not meet user requirements, the flux weakening function of the synchronous motor should be enabled to increase the speed.

EM730/EM730E has two flux weakening modes: direct calculation and automatic adjustment.

F06.21 Ones place=1, direct calculation

In the direct calculation mode, the flux weakening current is calculated according to the target speed and can be adjusted manually via the option 06.22. The lower the flux weakening current, the lower the total output current will be, but the desired effect of flux weakening may not be achieved.

F06.21 Ones place=2, automatic adjustment

In the automatic adjustment, the optimal flux weakening current will be selected automatically, but it may affect the dynamic performance of the system or become unstable.

The speed of flux weakening current adjustment can be changed by setting the proportional gain (F06.24) and integral time (F06.25). However, fast adjustment of the flux

weakening current adjustment may cause instability. This does not need to be changed manually under normal circumstances.

Function code	Function code name	Parameter description	Unit	Default setting	Attribute
F06.27	Self-learning gain at initial position	0 - 200	%	100	●

This parameter is used to determine the amplitude of the high-frequency current injected during the initial position identification. The larger this value, the higher the “squeak” sound will be.

Function code	Function code name	Parameter description	Unit	Default setting	Attribute
F06.28	Frequency of low frequency band of injection current	0.00-100.00 (100.00 is the rated frequency of the motor)	%	10.00	●
F06.29	Injection current of low frequency band	0.0-60.0 (100.0 is the rated current of the motor)	%	40.0	●
F06.30	Regulator gain of low frequency band of injection current	0.00 - 10.00		0.50	●
F06.31	Regulator integral time of low frequency band of injection current	0.00 - 300.00	ms	10.00	●
F06.32	Frequency of high frequency band of injection current	0.00-100.00 (100.00 is the rated frequency of the motor)	%	20.00	●
F06.33	Injection current f high frequency band	0.0-30.0 (100.0 is the rated current of the motor)	%	8.0	●
F06.34	Regulator gain of high frequency band of injection current	0.00 - 10.00		0.50	●
F06.35	Regulator integral time of high frequency band of injection current	0.00 - 300.00	ms	10.00	●

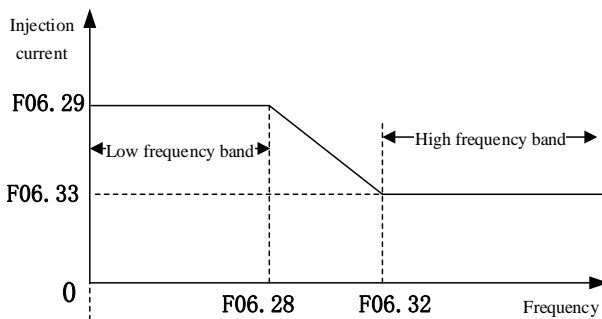

Fig. 7-22 Schematic Diagram of High Frequency Injection

The injection current depends on F06.29 in the low frequency band (output frequency <F06.28) and F06.33 in the high frequency band (output frequency > F06.32).

To get better results, the gain and integral time of the regulator can be adjusted. Default settings can be used under normal circumstances.

They must not be adjusted by non-professionals.

Function code	Function code name	Parameter description	Unit	Default setting	Attribute
F06.37	Stiffness coefficient of speed loop	0~20		12	●

In the vector control mode, the dynamic speed response of the inverter is adjusted by changing the speed proportional gain (ASR_P) and speed integral time (ASR_T) of the speed PI regulator. The increase in ASR_P or decrease in ASR_T may accelerate the dynamic response of the speed loop. If ASR_P is too large or ASR_T is too small, however, the system may be over-tuned to cause oscillation.

In case of any change in F06.37, the default values of F06.00-F06.03 will change accordingly. The adjustment intensity of the speed PI regulator can be changed. There are 21 optional groups of parameters in total. The larger the set value of F06.37, the larger the proportional gain is, the smaller the integral time is, and the more intense the speed PID regulation is. The smaller the set value of F06.37, the weaker the speed PID regulation is.

Function code	Function code name	Parameter description	Unit	Default setting	Attribute
F06.41	Open-loop low-frequency	0: VF		0	○

	processing of synchronous motor	1: IF 2: IF in start and VF in stop			
F06.42	Open-loop low-frequency processing range of synchronous motor	0.0 - 50.0	%	8.0	○
F06.43	IF injection current	0.0 - 600.0	%	80.0	○

The default settings of low frequency optimization options of the synchronous motor are suitable for most applications. If a larger torque is required at the low frequency, you can enable the IF mode.

Function code	Function code name	Parameter description	Unit	Default setting	Attribute
F06.46	Speed tracking proportional gain of synchronous motor	0.00 - 10.00		1.00	○
F06.47	Speed tracking integral gain of synchronous motor	0.00 - 10.00		1.00	○
F06.48	Filtering time constant of speed tracking of synchronous motor	0.00 - 10.00	ms	0.40	○
F06.49	Speed tracking control intensity of synchronous motor	1.0 - 100.0		5.0	○
F06.50	Speed tracking control threshold of synchronous motor	0.00 - 10.00		0.20	○
F06.51	Injection current (Iq) rise time of synchronous motor	0.010 - 1.000	S	5.0	○

Tuning parameters for speed tracking of the synchronous motor.

7.8 F07 protection parameter group

Function code	Function code name	Parameter description							Unit	Default setting	Attribute	
F07.00	Protection shield	<i>E20</i>	*	<i>E13</i>	<i>E06</i>	*	<i>E04</i>	<i>E07</i>	<i>E08</i>		0*00*000	○
		0: valid protection 1: shielded protection										

Bit setting = 0: when the inverter detects the protection corresponding to this bit, it will stop the output and enter the protection status.

Bit setting = 1: when the inverter detects the protection corresponding to this bit, it will keep the original status without protection.

This code is subject to bit operation. You only need to set the corresponding bit to 0 or 1.

As shown in the table below:

Table 7-10 Detailed Definition of Protection Shield Bits

Protection code	$E20$	*	$E13$	$E06$	*	$E04$	$E07$	$E08$
Corresponding bit	7	6	5	4	3	2	1	0
Settings	0/1	*	0/1	0/1	0/1	*	0/1	0/1

For example: To shield the $E07$ protection, you only need to set the first bit corresponding to $E07$ to 1, i.e. F07.00=xxx xxx1x.

To shield the $E08$ and $E13$ protection, you only need to set the 0th bit corresponding to $E08$ and the 5th bit corresponding to $E13$ to 1. That is, F07.00=xx1 xxx1.

	Unless there are special needs, please do not shield any protection function, so as to prevent the inverter from damage as a result of protection failure.
--	--

Function code	Function code name	Parameter description	Unit	Default setting	Attribute
F07.01	Motor overload protection gain	0.20 - 10.00		1.00	●
F07.02	Motor overload pre-alarm coefficient	50 - 100	%	80	●

The inverse time curve of motor overload protection is: $200\% \times (F07.01) \times$ rated current of the motor, sending an alarm of motor overload protection ($E13$) if the duration reaches one minute; $150\% \times (F07.01) \times$ rated current of the motor, sending an alarm of motor overload ($E13$) if the duration reaches 15 minutes.

The user needs to set F07.01 correctly according to the actual overload capacity of the motor. If the set value is too large, the motor may be damaged as a result of overheat but the inverter may not send an alarm!

The F07.02 warning coefficient is used to determine the extent of motor overload for a protection warning. The larger this value, the less the warning is advanced.

When the cumulative output current of the inverter is greater than the product of the inverse time curve of load by F07.02, the multi-function digital DO terminal of the inverter will output the valid signal “17: Motor overload pre-alarm”.

Function code	Function code name	Parameter description	Unit	Default setting	Attribute
F07.06	Bus voltage control	Ones place: Instantaneous stop/no-stop function options		2	○

	options	0: Invalid 1: deceleration 2: deceleration to stop Tens place: Overvoltage stall function options 0: Invalid 1: valid			
F07.07	Voltage of overvoltage stall control	110.0 - 150.0 (380V, 100.0=537V)	%	131.0 (703V)	○

F07.06=0X: Invalid

The overvoltage stall is invalid. It is recommended not to set it to 0 in the case of no external braking unit.

The undervoltage stall is also invalid.

When the value in the ones place is 1 or 2, F07.30 is the reference deceleration time.

F07.06=1X: Valid overvoltage stall

When the overvoltage stall is valid, the stall control voltage is dependent on F07.07.

The DC bus overvoltage is usually caused by deceleration. Due to the energy feedback during deceleration, the DC bus voltage will rise.

When the DC bus voltage is greater than the overvoltage threshold and the overvoltage stall is valid (F07.06=2/3), the deceleration of the inverter will be suspended, the output frequency will remain unchanged, and the energy feedback will be stopped until the DC bus voltage is normal. Then the inverter will restart deceleration. The process of overvoltage stall protection in deceleration is shown in Fig. 7-.

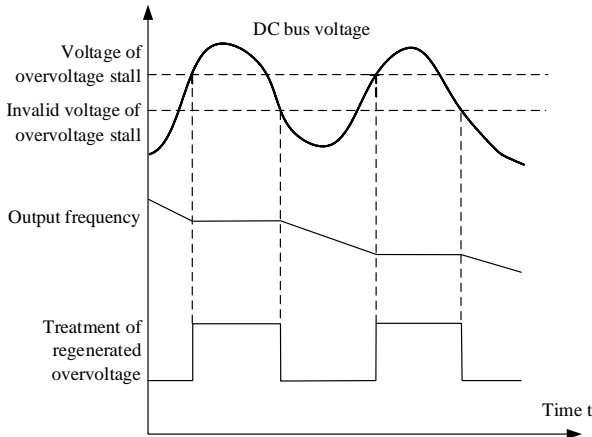

Fig. 7-23 Schematic Diagram of Overvoltage Stall Protection

Function code	Function code name	Parameter description	Unit	Default setting	Attribute
F07.08	Instantaneous stop/no-stop operating voltage	60.0 to instantaneous stop/no-stop recovery voltage (100.0 = standard bus voltage)		76.0	○
F07.09	Instantaneous stop/no-stop recovery voltage	Instantaneous stop/no-stop operating voltage to 100.0	%	86.0	●
F07.10	Check time for instantaneous stop/no-stop recovery voltage	0.00-100.00	s	0.5	●
F07.30	Instantaneous stop/no-stop deceleration time	0.00 - 300.00	s	20.00	○

When the bus voltage is lower than the instantaneous stop/non-stop action voltage (F07.08), the inverter will be in the power-down status. When the bus voltage is higher than the instantaneous stop/non-stop recovery voltage (F07.09), and the judgment time (F07.10) for the instantaneous stop/non-stop recovery voltage is up, the inverter will recover normal operation.

When the ones place of the instantaneous stop/non-stop option of F07.06 bus voltage control is set to “1: Slow down”, as shown in Fig. 7-24: When the bus voltage is lower than the instantaneous stop/non-stop action voltage (F07.08), the inverter will slow down at the speed set based on the deceleration time for the instantaneous stop/non-stop action (F07.30). When the bus

voltage is higher than the instantaneous stop/non-stop recovery voltage (F07.09), the inverter will not slow down. When the cumulative time reaches the judgement time for instantaneous stop/non-stop recovery voltage (F07.10), the inverter will start to acceleration, and the frequency will gradually return to the set value.

When the ones place of the instantaneous stop/non-stop option of F07.06 bus voltage control is set to “2: Slow down to stop”, the action is similar to that of the option 1. When the bus voltage reaches the instantaneous stop/non-stop action voltage, the speed set based on the instantaneous stop/non-stop slowdown time (F07.30) will constantly decrease to 0, regardless of voltage recovery.

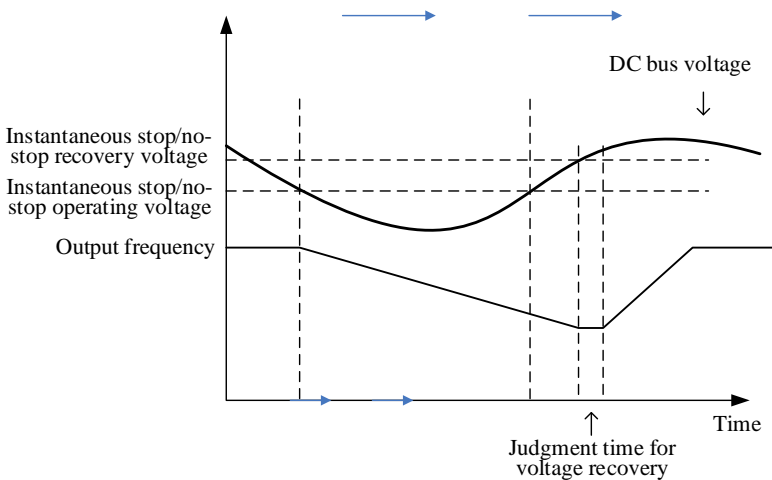

Fig. 7-24 Schematic Diagram of Instantaneous Stop/Non-stop Deceleration Function

Function code	Function code name	Parameter description	Unit	Default setting	Attribute
F07.11	Current limit control	0: Invalid 1: limit mode 1 2: limit mode 2		2	○
F07.12	Current limit level	20.0-180.0 (100% = rated current of inverter)	%	150.0	●

F07.11=0: invalid

The current limit does not work.

F07.11=1: limit mode 1

F07.11=2: limit mode 2

When the output current reaches the current limit level (F07.12) and the current limit control is valid (F07.11=1) during operation, the current limit function of the inverter will be enabled. The output frequency will be reduced to limit the increase in output current, thus disabling the overcurrent stall of the inverter. When the output current decreases to below the current limit level, the original running status will be restored. The current limit process is shown in Fig. 7-25.

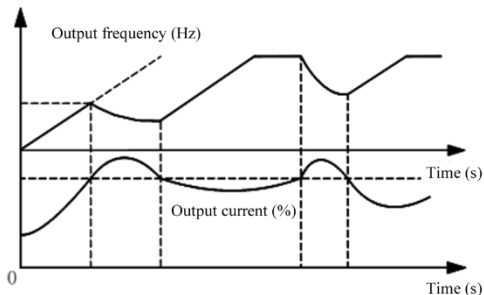



Fig. 7-25 Current Limit Process

F07.12 is used to set the operating conditions of current limit. If the current of the inverter is greater than the set value of this code, the current limit function will be enabled, thus controlling the output current not to exceed the current limit level.

 The current limit is valid only for the V/F drive mode. It is recommended to use this function in the case of large inertia or fan type loads or driving of multiple motors by a single inverter.

Function code	Function code name	Parameter description	Unit	Default setting	Attribute
F07.13	Quick current limit options	0: Invalid 1: valid		0	○

F07.13=0: invalid

The quick current limit does not work.

F07.13=1: valid

The quick current limit can reduce overcurrent protections.

Function code	Function code name	Parameter description	Unit	Default setting	Attribute
F07.14	Protection retries	0-20; 0: Disable protection retry		0	○
F07.15	Options of digital output action in protection retries	0: no action 1: action		0	○
F07.16	Interval of protection retries	0.01 - 30.00	s	0.50	●
F07.17	Restoration time of protection retries	0.01 - 30.00	s	10.00	●
F07.18	Action option of protection	$\epsilon 07$ * $\epsilon 02$ $\epsilon 05$ $\epsilon 05$ $\epsilon 04$		0 *0000	○
		0: allow protection retry 1: disable protection retry			
F07.32	Action option 2 of protection	$\epsilon 10$ $\epsilon 13$ $\epsilon 15$ $\epsilon 16$ * $\epsilon 19$ $\epsilon 20$ *		000 00000	○
		0: allow protection retry 1: disable protection retry			
F07.34	Action option 3 of protection	* * * * * $\epsilon 09$ $\epsilon 17$		*****00	○
		0: allow protection retry 1: disable protection retry			

The function of protection retry is to prevent the impact of occasional protection on the normal operation of the system. This is valid only for protections of F07.18, F07.32 and F07.34.

If protection retry is enabled, this will be performed after a corresponding protection. That is, the protection will be reset. The protection status depends on F07.15 and the output of the digital output terminal. If a fault is still detected after the protection retry interval, the protection retry will be continued to the set number of protection retries (F07.14) and then the corresponding protection will be reported. If the fault is not detected after several protection retries, the protection retries will be deemed successful and the inverter will continue to run normally.

When protection retries succeed and no trip protection is enabled within the recovery time (F07.17), the number of protection retries will be cleared. When a protection is enabled again, protection retries will be performed from zero. In case of any trip protection within this period,

protection retries will be carried out based on the last count.

Function code	Function code name	Parameter description								Unit	Default setting	Attribute
F07.19	Action option 1 of protection	<i>E21</i>	<i>E16</i>	<i>E15</i>	<i>E14</i>	<i>E13</i>	*	<i>E08</i>	<i>E07</i>		000 00*00	○
		0: free stop 1: stop according to stop mode										
F07.20	Action option 2 of protection	<i>E28</i>	<i>E27</i>		*		<i>E23</i>				00*0	○
		0: free stop 1: stop according to stop mode										

With regard to some protections, the action mode of the inverter can be selected via this function code. The inverter will stop running freely when the corresponding bit is set to 0 and according to the stop mode (F04.19) when the corresponding bit is set to 1.

These two function codes are subject to bit operation. You only need to set the corresponding bit to 0 or 1. As shown in the table below:

Table 7-11 Detailed Definition of Protection Action Bits

F07.19	<i>E21</i>	<i>E16</i>	<i>E15</i>	<i>E14</i>	<i>E13</i>	*	<i>E08</i>	<i>E07</i>
F07.20	*	*	*	*	<i>E28</i>	<i>E27</i>	*	<i>E23</i>
Corresponding bit	7	6	5	4	3	2	1	0
Settings	0/1	0/1	0/1	0/1	0/1	0/1	0/1	0/1

For example: To stop the inverter according to the stop mode (F04.19) after the *E08* and *E13* protection is enabled, you only need to set the 1st bit corresponding to *E08* and the 3rd bit corresponding to *E13* to 1. That is, F07.19=xxx x1x1x.

Function code	Function code name	Parameter description	Unit	Default setting	Attribute
F07.21	Options of load loss protection	0: invalid 1: valid		0	●
F07.22	Load loss detection level	0.0-100.0	%	20.0	●
F07.23	Load loss detection time	0.0 - 60.0	s	1.0	●
F07.24	Options of load loss protection action	0: trip protection, free stop 1: trip protection, stop according to stop mode 2: Continue to run, with DO status output		1	○

When the off-load protection is valid (F07.21=1), the inverter will be in the running status without DC braking, and the output current is below the off-load detection level (F07.22) and maintained for the off-load detection time (F07.23), the inverter will be in the off-load status. Specific processing depends on F07.24.

Function code	Function code name	Parameter description	Unit	Default setting	Attribute
F07.27	AVR function	0: Invalid 1: valid 2: automatic		1	○

F07.27=0: invalid

The automatic voltage regulation (AVR) function is invalid.

F07.27=1: valid

The AVR function is continuously valid. If the input voltage is lower than the rated input voltage, and the output frequency is greater than the corresponding frequency on the VF curve, the inverter will output the output the maximum voltage to maximize the power output of the motor. If the input voltage is higher than the rated input voltage, the output voltage of the inverter will decrease, and the VF ratio will remain unchanged.

F07.27=2: automatic

The AVR function is valid automatically (invalid during deceleration): the inverter will automatically adjust the output voltage according to changes in the actual grid voltage, to keep it at the rated output voltage.

Function code	Function code name	Parameter description	Unit	Default setting	Attribute
F07.28	Stall protection detection time	0.0-6000.0(0.0: no stall protection detection)	s	0.0	○
F07.29	Stall control intensity	0 - 100	%	100	○

When the continuous stall time exceeds the set value of F07.28, the driver will report a stall protection.

In the stall status, the driver will perform automatic control according to the set value of F07.29. The intensity setting depends on the on-site application, instead of maximization.

7.9 Multi-segment Speed and Simple PLC Parameter Group of F08 Group

Function code	Function code name	Parameter description	Unit	Default setting	Attribute
F08.00	Multi-segment speed 1	0.00 to maximum frequency F00.16	Hz	0.00	●
F08.01	Multi-segment speed 2	0.00 to maximum frequency F00.16	Hz	5.00	●
F08.02	Multi-segment speed 3	0.00 to maximum frequency F00.16	Hz	10.00	●
F08.03	Multi-segment speed 4	0.00 to maximum frequency F00.16	Hz	15.00	●
F08.04	Multi-segment speed 5	0.00 to maximum frequency F00.16	Hz	20.00	●
F08.05	Multi-segment	0.00 to maximum frequency	Hz	25.00	●

	speed 6	F00.16			
F08.06	Multi-segment speed 7	0.00 to maximum frequency F00.16	Hz	30.00	●
F08.07	Multi-segment speed 8	0.00 to maximum frequency F00.16	Hz	35.00	●
F08.08	Multi-segment speed 9	0.00 to maximum frequency F00.16	Hz	40.00	●
F08.09	Multi- speed 10	0.00 to maximum frequency F00.16	Hz	45.00	●
F08.10	Multi-segment speed 11	0.00 to maximum frequency F00.16	Hz	50.00	●
F08.11	Multi-segment speed 12	0.00 to maximum frequency F00.16	Hz	50.00	●
F08.12	Multi-segment speed 13	0.00 to maximum frequency F00.16	Hz	50.00	●
F08.13	Multi-segment speed 14	0.00 to maximum frequency F00.16	Hz	50.00	●
F08.14	Multi-segment speed 15	0.00 to maximum frequency F00.16	Hz	50.00	●

The 16-segment speed can be provided according to the multi-segment speed control terminal, 15-segment frequency command and digital frequency setting F00.07.

Table 7-12 Combination of Multi-segment Speed Command and Multi-segment Speed Terminal

Segment Speed	Multi-segment speed terminal 4	Multi-segment speed terminal 3	Multi-segment speed terminal 2	Multi-segment speed terminal 1	Selected frequency	Corresponding function code
1	Invalid	Invalid	Invalid	Invalid	Digital frequency setting	Depending on F00.07
2	Invalid	Invalid	Invalid	Valid	Multi-segment speed 1	F08.00
3	Invalid	Invalid	Valid	Invalid	Multi-segment speed 2	F08.01
4	Invalid	Invalid	Valid	Valid	Multi-segment speed 3	F08.02
5	Invalid	Valid	Invalid	Invalid	Multi-segment speed 4	F08.03
6	Invalid	Valid	Invalid	Valid	Multi-segment speed 5	F08.04
7	Invalid	Valid	Valid	Invalid	Multi-segment	F08.05

					speed 6	
8	Invalid	Valid	Valid	Valid	Multi-segment speed 7	F08.06
9	Valid	Invalid	Invalid	Invalid	Multi-segment speed 8	F08.07
10	Valid	Invalid	Invalid	Valid	Multi-segment speed 9	F08.08
11	Valid	Invalid	Valid	Invalid	Multi- speed 10	F08.09
12	Valid	Invalid	Valid	Valid	Multi-segment speed 11	F08.10
13	Valid	Valid	Invalid	Invalid	Multi-segment speed 12	F08.11
14	Valid	Valid	Invalid	Valid	Multi-segment speed 13	F08.12
15	Valid	Valid	Valid	Invalid	Multi-segment speed 14	F08.13
16	Valid	Valid	Valid	Valid	Multi-segment speed 15	F08.14

Precautions for setting:

- ★ The start and stop in multi-segment speed operation depends on the function code F00.02.
- ★ The acceleration/deceleration time in multi-segment speed operation can be controlled by the external terminal with the acceleration/deceleration time function.

The direction of multi-segment speed operation is controlled by the terminals F/R and RUN.

Function code	Function code name	Parameter description	Unit	Default setting	Attribute
F08.15	Simple PLC running mode	0: stop after a single run 1: stop after a limited number of cycles 2: run at the last segment after a limited number of cycles 3: continuous cycles		0	●
F08.16	Limited number of cycles	1 - 10000		1	●

In addition to the multi-segment speed mode, it also has the simple PLC function. There are

four running modes in total, as detailed in Table 7-13.

Table 7-13 Details of PLC Running Mode

F08.15	Description
0	The inverter will be stopped after running in the last segment.
1	The inverter will run cyclically and be stopped after the set cycles. The number of cycles depends on the function code F08.16.
2	The inverter will run cyclically and keep the speed of the last segment after running in the last segment, until a stop command is received. The number of cycles depends on the function code F08.16.
3	The inverter will continue cyclic operation until a stop command is received.

★ The last segment refers to the segment that is not set to 0, judged from the running time (F08.48) of the 15th segment toward the 1st segment.

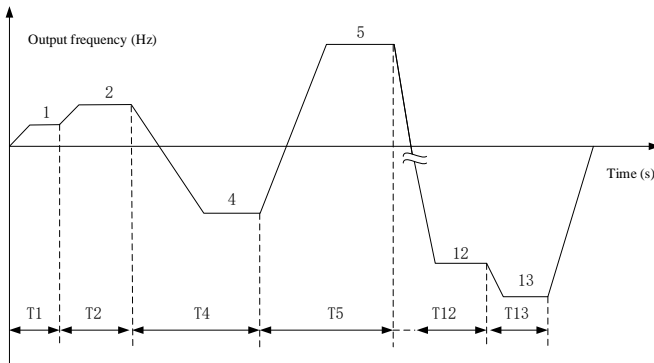

Fig. 7-26 Schematic Diagram of Simple PLC Operation

Fig. 7-26 shows the operation diagram in the running mode “0: stop after a single run”. Since the running time of the 3rd segment is set to 0 (F08.24=0.0), the 3rd segment will not be put into actual operation. The running time of the 14th and 15th segments is set to 0 (F08.46=0.0, F08.48=0.0), so the last segment is the 13th segment, and the inverter will be stopped after running in the 13th segment.

Function code	Function code name	Parameter description	Unit	Default setting	Attribute
F08.17	Simple PLC memory options	Ones place: Stop memory options 0: no memory (from the first segment)		00	●

		1: memory (from the moment of stop) Tens place: Power-down memory options 0: no memory (from the first segment) 1: Memory (from the power-down moment)			
--	--	--	--	--	--

The PLC stop memory is to record the current simple PLC running times (F18.10), running stage (F18.11), and running time at the current stage (F18.12). The inverter will continue to run from the memory stage during next operation. If you choose no memory, the PLC process will be performed every time the inverter is started.

The PLC power-down memory is to record the current simple PLC running times (F18.10), running stage (F18.11), and running time at the current stage (F18.12) before the memory is powered off. The inverter will continue to run from the memory stage when the inverter is powered on again. If you choose no memory, the PLC process will be performed every time the inverter is powered on.

Function code	Function code name	Parameter description	Unit	Default setting	Attribute
F08.18	Simple PLC time unit	0: s (second) 1: min (minute)		0	●

In order to meet different working conditions, the running time involved in the PLC function is set to a numerical value. Its specific meaning needs to be set in conjunction with the simple PLC time unit (F08.18). At present, there are two types of unit: second and minute.

Function code	Function code name	Parameter description	Unit	Default setting	Attribute
F08.19	Setting of the first segment	Ones place: Running direction options 0: forward 1: reverse Tens place: Acceleration and deceleration time options 0: acceleration and deceleration time 1 1: acceleration and deceleration time 2 2: acceleration and		0	●

		deceleration time 3 3: acceleration and deceleration time 4			
F08.20	Running time of the first segment	0.0 - 6000.0	s/min	5.0	●
F08.21	Setting of the second segment	Ones place: Running direction options 0: forward 1: reverse Tens place: Acceleration and deceleration time options 0: acceleration and deceleration time 1 1: acceleration and deceleration time 2 2: acceleration and deceleration time 3 3: acceleration and deceleration time 4		0	●
F08.22	Running time of the second segment	0.0 - 6000.0	s/min	5.0	●
F08.23	Setting of the third segment	Ones place: Running direction options 0: forward 1: reverse Tens place: Acceleration and deceleration time options 0: acceleration and deceleration time 1 1: acceleration and deceleration time 2 2: acceleration and deceleration time 3 3: acceleration and deceleration time 4		0	●
F08.24	Running time of the third segment	0.0 - 6000.0	s/min	5.0	●
F08.25	Setting of the fourth segment	Ones place: Running direction options 0: forward 1: reverse Tens place: Acceleration and deceleration time options		0	●

		0: acceleration and deceleration time 1 1: acceleration and deceleration time 2 2: acceleration and deceleration time 3 3: acceleration and deceleration time 4			
F08.26	Running time of the fourth segment	0.0 - 6000.0	s/min	5.0	●
F08.27	Setting of the fifth segment	Ones place: Running direction options 0: forward 1: reverse Tens place: Acceleration and deceleration time options 0: acceleration and deceleration time 1 1: acceleration and deceleration time 2 2: acceleration and deceleration time 3 3: acceleration and deceleration time 4		0	●
F08.28	Running time of the fifth segment	0.0 - 6000.0	s/min	5.0	●
F08.29	Setting of the sixth segment	Ones place: Running direction options 0: forward 1: reverse Tens place: Acceleration and deceleration time options 0: acceleration and deceleration time 1 1: acceleration and deceleration time 2 2: acceleration and deceleration time 3 3: acceleration and deceleration time 4		0	●
F08.30	Running time of the sixth segment	0.0 - 6000.0	s/min	5.0	●
F08.31	Setting of the	Ones place: Running		0	●

	seventh segment	direction options 0: forward 1: reverse Tens place: Acceleration and deceleration time options 0: acceleration and deceleration time 1 1: acceleration and deceleration time 2 2: acceleration and deceleration time 3 3: acceleration and deceleration time 4			
F08.32	Running time of the seventh segment	0.0 - 6000.0	s/min	5.0	●
F08.33	Setting of the eighth segment	Ones place: Running direction options 0: forward 1: reverse Tens place: Acceleration and deceleration time options 0: acceleration and deceleration time 1 1: acceleration and deceleration time 2 2: acceleration and deceleration time 3 3: acceleration and deceleration time 4		0	●
F08.34	Running time of the eighth segment	0.0 - 6000.0	s/min	5.0	●
F08.35	Setting of the ninth segment	Ones place: Running direction options 0: forward 1: reverse Tens place: Acceleration and deceleration time options 0: acceleration and deceleration time 1 1: acceleration and deceleration time 2 2: acceleration and deceleration time 3		0	●

		3: acceleration and deceleration time 4			
F08.36	Running time of the ninth segment	0.0 - 6000.0	s/min	5.0	●
F08.37	Setting of the tenth segment	<p>Ones place: Running direction options 0: forward 1: reverse</p> <p>Tens place: Acceleration and deceleration time options 0: acceleration and deceleration time 1 1: acceleration and deceleration time 2 2: acceleration and deceleration time 3 3: acceleration and deceleration time 4</p>		0	●
F08.38	Running time of the tenth segment	0.0 - 6000.0	s/min	5.0	●
F08.39	Setting of the eleventh segment	<p>Ones place: Running direction options 0: forward 1: reverse</p> <p>Tens place: Acceleration and deceleration time options 0: acceleration and deceleration time 1 1: acceleration and deceleration time 2 2: acceleration and deceleration time 3 3: acceleration and deceleration time 4</p>		0	●
F08.40	Running time of the eleventh segment	0.0 - 6000.0	s/min	5.0	●
F08.41	Setting of the twelve segment	<p>Ones place: Running direction options 0: forward 1: reverse</p> <p>Tens place: Acceleration and deceleration time options 0: acceleration and</p>		0	●

		deceleration time 1 1: acceleration and deceleration time 2 2: acceleration and deceleration time 3 3: acceleration and deceleration time 4			
F08.42	Running time of the twelfth segment	0.0 - 6000.0	s/min	5.0	●
F08.43	Setting of the thirteenth segment	Ones place: Running direction options 0: forward 1: reverse Tens place: Acceleration and deceleration time options 0: acceleration and deceleration time 1 1: acceleration and deceleration time 2 2: acceleration and deceleration time 3 3: acceleration and deceleration time 4		0	●
F08.44	Running time of the thirteenth segment	0.0 - 6000.0	s/min	5.0	●
F08.45	Setting of the fourteenth segment	Ones place: Running direction options 0: forward 1: reverse Tens place: Acceleration and deceleration time options 0: acceleration and deceleration time 1 1: acceleration and deceleration time 2 2: acceleration and deceleration time 3 3: acceleration and deceleration time 4		0	●
F08.46	Running time of the fourteenth segment	0.0 - 6000.0	s/min	5.0	●
F08.47	Setting of the fifteenth segment	Ones place: Running direction options		0	●

		0: forward 1: reverse Tens place: Acceleration and deceleration time options 0: acceleration and deceleration time 1 1: acceleration and deceleration time 2 2: acceleration and deceleration time 3 3: acceleration and deceleration time 4			
F08.48	Running time of the fifteenth segment	0.0 - 6000.0	s/min	5.0	●

When the simple PLC is running, the operating frequency, operating direction, acceleration/deceleration time and operating time in the entire segment can be set separately. This is described below with the 13th segment (the last segment) as an example. The specific operation is shown in Fig. 7-.

F08.12=50.00: the operating frequency of 13th segment is 50.00Hz.

F08.43=31: the operating direction in the 13th segment is reverse, and the acceleration and deceleration are controlled based on the acceleration and deceleration time 4 (F15.07/F15.08).

F08.44=5.0: the operating time in the 13th segment is 5.0s (F08.18=0 by default).

7.10 PID Function Parameter Group of F09 Group

The EM730/EM730E series inverter has a process PID function, as described in this section. Process PID control is mainly for pressure control, flow control and temperature control.

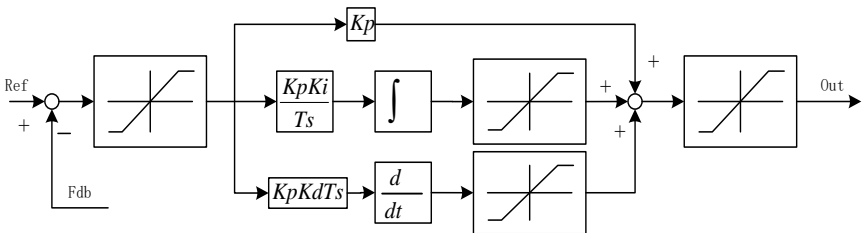

Fig. 7-27 Block Diagram of Process PID

PID control is a kind of closed-loop control. The output signal (Out) of the object controlled by the system is fed back to the PID controller, and the output of the controller is adjusted after PID operation, thus forming one or more closed loops. This function is to make the output value (Out) of the object controlled by the system consistent with the set target value (Ref). The specific block diagram is shown in Fig. 7-27.

The PID controller is used for control by calculating the control quantity with three calculation factors, i.e. proportion (P), integral (I) and differential (D), according to the difference between the set target (Ref) and feedback signal (Fdb). The features of each calculation factor are as follows:

Proportion (P):

Proportional control is one of the simplest control modes. The output of the controller is proportional to the input error signal. When only proportional control is enabled, there are steady-state errors in the system output.

Integral (I):

In the integral control mode, the output of the controller is proportional to the integral of the input error signal. Steady-state errors can be eliminated, so that the system has no steady-state errors while operating in the steady state. However, drastic changes cannot be tracked.

Differential (D):

In the differential control mode, the output of the controller is proportional to the differential (i.e. change rate of the error) of the input error signal. This can predict the trend of changes in errors, quickly respond to drastic changes, and improve the dynamic features of the system in the control process.

Function code	Function code name	Parameter description	Unit	Default setting	Attribute
F09.00	PID setting source	0: digital PID setting 1: AI1 2: AI2 3: retention 4: retention 5: PULSE, high-frequency pulse (X5) 6: communication setting (percentage setting)		0	○
F09.01	Digital PID setting	0.0 to PID setting feedback range F09.03		0.0	●
F09.03	PID setting feedback range	0.1 - 6000.0		100.0	●

F09.00=0: digital PID setting F09.01

The PID setting depends on the digital PID setting (F09.01), and the specific percentage is $F09.01/F09.03 * 100.00\%$.

F09.00=1:AI1

F09.00=2:AI2

For the details of AI1 to AI2, refer to the description of F00.04. For PID setting, the percentage is directly given, and the maximum output is 100.00%.

F09.00=5: PULSE high-frequency pulse (X5)

The set percentage of PID is directly dependent on the HDI (percentage).

For the details of AI1-AI2 and X5, see the description of F00.04. When used as the PID setting, the percentage will directly turn the set value, and the maximum output is 100.00%.

F09.00=6: communication setting

The percentage of PID setting depends directly on the communication (percentage).

- If the master-slave communication (F10.05=1) is enabled and the inverter works as the slave (F10.06=0), the specific setting percentage is “700FH (master-slave communication setting) * F10.08 (slave receiving proportional coefficient)”, and the 700FH data range is -100.00% to 100.00%, as detailed in Table 12-31.
- For the general communication (F10.05=0), the specific setting percentage is “7004H (communication setting of process PID setting)”, and the 7004H data range is -100.00% to 100.00%, as detailed in Table 12-31.

Function code	Function code name	Parameter description	Unit	Default setting	Attribute
F09.02	PID feedback source	1: AI1 2: AI2 3: retention 4: retention 5: PULSE, high-frequency pulse (X5) 6: Communication setting		1	○

F09.02=1:AI1

F09.02=2: AI2

The PID feedback percentage is directly dependent on the AI (percentage).

For the details of AI1 to AI2, see the description of F00.04. When is used as the PID feedback, the percentage will directly turn the feedback value, and the maximum output is

100.00%.

F09.02=5: PULSE high-frequency pulse (X5)

The set percentage of PID is directly dependent on the HDI (percentage).

For the details of AI1-AI2 and X5, see the description of F00.04. When used as the PID setting, the percentage will directly turn the set value, and the maximum output is 100.00%.

F09.02=6: communication setting

The PID feedback percentage is directly dependent on the communication (percentage).

- If the master-slave communication (F10.05=1) is enabled and the inverter works as the slave (F10.06=0), the specific feedback percentage is “700FH (master-slave communication setting) * F10.08 (slave receiving proportional coefficient)”, and the 700FH data range is -100.00% to 100.00%, as detailed in Table 12-31.
- For the general communication (F10.05=0), the specific feedback percentage is “7005H (communication setting of process PID feedback)”, and the 7005H data range is -100.00% to 100.00%, as detailed in Table 12-31.

Function code	Function code name	Parameter description	Unit	Default setting	Attribute
F09.04	PID positive and negative action selection	0: positive 1: negative		0	○

The process PID action mode depends jointly on the setting of the function code F09.04 and the status of the input function “44: PID positive/negative action switching”, as detailed in Table 7-14.

Table 7-14 Description of PID Positive/Negative Action

F09.04	44: PID positive/negative switching	Mode of action	Note
0	0	Positive action	Both the deviation and output are positive.
0	1	Negative action	The deviation is positive and the output is negative.
1	0	Negative action	The deviation is positive and the output is negative.
1	1	Positive action	Both the deviation and output are positive.

Note: The deviation in PID control is usually “setting - feedback”.

- When the feedback signal is greater than the PID setting, the output frequency of the

inverter should decrease for PID balance. Take the water supply control as an example. When the pressure increases, the pressure feedback will increase. The output frequency of the inverter must be decreased to reduce the pressure and keep the constant pressure. In this case, the PID should be set to the positive action.

- When the feedback signal is greater than the PID setting, the output frequency of the inverter needs to increase for PID balance. Take temperature control as an example. The PID regulator needs to be set to negative action to control the temperature.

Function code	Function code name	Parameter description	Unit	Default setting	Attribute
F09.05	Proportional gain 1	0.00-100.00		0.40	●
F09.06	Integral time 1	0.000 to 30.000; 0.000: no integral	s	2.000	●
F09.07	Differential time 1	0.000-30.000	ms	0.000	●
F09.08	Proportional gain 2	0.00-100.00		0.40	●
F09.09	Integral time 2	0.000 to 30.000; 0.000: no integral	s	2.000	●
F09.10	Differential time 2	0.000-30.000	ms	0.000	●
F09.11	PID parameter switching conditions	0: no switching 1: switching via digital input terminal 2: automatic switching according to deviation 3: Automatic switching by frequency		0	●
F09.12	PID parameter switching deviation 1	0.00 - F09.13	%	20.00	●
F09.13	PID parameter switching deviation 2	F09.12 - 100.00	%	80.00	●

For a variety of complex scenes, two sets of PID parameters have been introduced into the process PID module. Switching or linear interpolation of the two sets of parameters can be performed according to the function setting (F09.11) and input conditions [e.g. input function “43: PID parameter switching”, and deviation $e(k)$]. See the instruction Table 7-15 for details.

Table 7-15 Description of PID Parameter Options

Method		Description
F09.11	Other conditions	
0	--	PID parameters are not switched. The first group of parameters is used.
1	43: PID parameter switching	PID parameters are switched via the digital input terminal (43: PID parameter switching).
	0	Invalid switching, the first group of parameters
	1	Valid switching, the second group of parameters
2	$ e(k) > F09.12/13$	PID parameters are automatically switched according to the deviation.
	$ e(k) < F09.12$	The first group of parameters
	$ e(k) < F09.13$	The second group of parameters
	Middle	According to the deviation, linear interpolation is performed based on the two groups of parameters.
3	$ P \sim F09.12/13$	PID parameters are automatically switched by frequency.
	$ P < F09.12$	The first group of parameters
	$ P > F09.13$	The second group of parameters
	Middle	According to the frequency, linear interpolation is performed based on the two groups of parameters.

As described in the table, when the function code F09.11 is set to 0, the PID parameters will not be switched, and the first group of parameters (F09.05 to F09.07) will prevail; when the function code is set to 1, the PID parameters will be selected according to the status of the input function “43: PID parameter switching”; when the function code 2 is used, the PID parameters will be selected according to the absolute value $|e(k)|$ ($=|\text{setting-feedback}|$) of the current deviation and the relationship between the function codes F09.12 and F09.13, or the linear difference may be used; when the function code 3 is used, processing is similar to that of the option 2, the PID parameters will be selected according to the percentage of the current output frequency to maximum frequency $|P| = (\text{output frequency}/\text{maximum frequency} * 100\%)$ and the relationship between the function codes F09.12 and F09.13, or the linear difference may be used.

In the case of “ $F09.12 \leq |e(k)| \leq F09.13$ ”, the current PID parameters are obtained through linear interpolation of the first and second groups of parameters. The specific principle is shown by the intermediate segment in Fig. 9-28

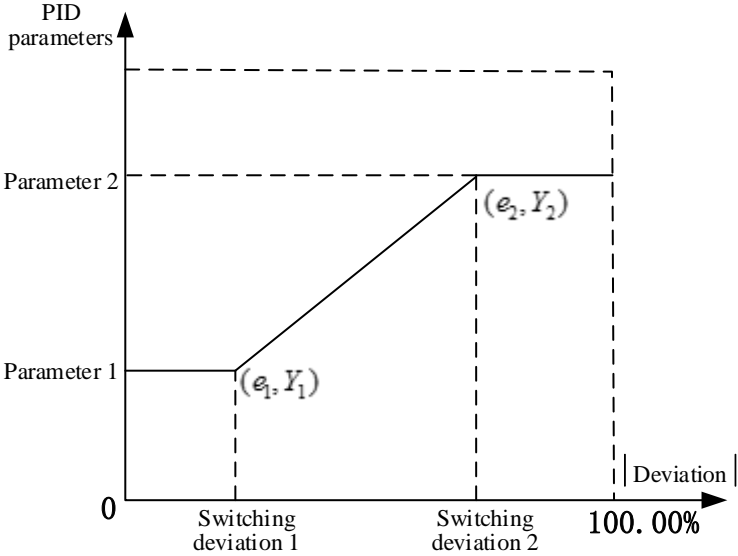

Fig. 9-28 Schematic Diagram of Automatic Switching of PID Parameters based on Deviation (F19.11=2)

Function code	Function code name	Parameter description	Unit	Default setting	Attribute
F09.14	Initial PID value	0.00-100.00	%	0.00	●
F09.15	PID initial value holding time	0.00~650.00	s	0.00	●

The inverter starts running, and the process PID module constantly outputs the initial PID value (F09.14) for the initial PID holding time (F09.15). Then the output is adjusted by the PID based on the deviation. Specific effects are shown in Fig. 9-29.

When the initial PID holding time is set to 0.00s, i.e. F09.15=0.00, the initial PID output function will be invalid.

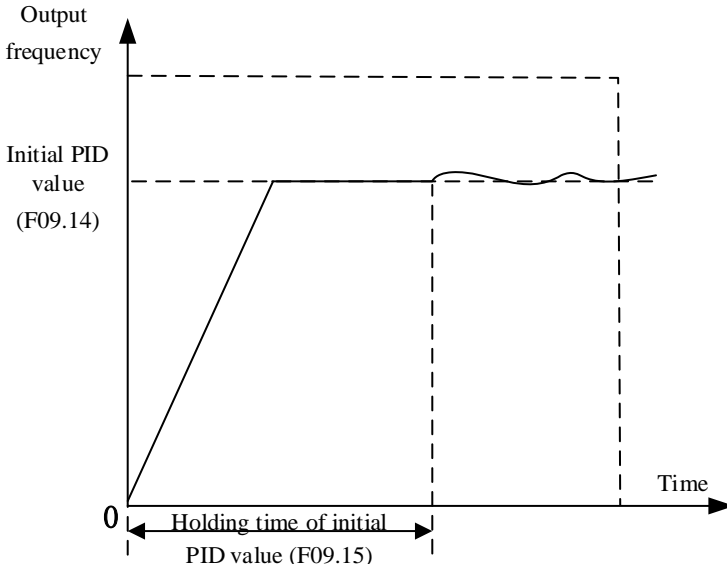

Fig. 9-29 Schematic Diagram of Initial PID Output

Function code	Function code name	Parameter description	Unit	Default setting	Attribute
F09.16	Upper limit of PID output	F09.17 - +100.0	%	100.0	●
F09.17	Lower limit of PID output	-100.0 - F09.16	%	0.0	●

The PID output is limited. The output range of the PID module in the whole process is (F09.17, F09.16). That is, if the actual adjustment result is beyond this range, the output will be based on the boundaries.

Function code	Function code name	Parameter description	Unit	Default setting	Attribute
F09.18	PID deviation limit	0.00-100.00 (0.00: invalid)	%	0.00	●

When the deviation between the PID setting and feedback is less than or equal to the deviation limit (F09.18), the PID will stop the adjustment. When the deviation between the setting and feedback is smaller, the output frequency will remain stable. This is valid for some closed-loop control applications.



If the input terminal function “41: process PID pause” is valid, the PID will also stop the adjustment. Users need to use these two modes together.

Function code	Function code name	Parameter description	Unit	Default setting	Attribute
F09.19	PID differential limit	0.00-100.00	%	5.00	●

The differential (D) component of the PID regulator must not be greater than the PID differential limit (F09.19), in order to avoid the excessive deviation and output at a certain moment to cause system oscillations. If this value is set correctly, the impact of sudden interference on the system can be well suppressed.

Function code	Function code name	Parameter description	Unit	Default setting	Attribute
F09.20	PID integral separation threshold	0.00-100.00 (100.00% = invalid integral separation)	%	100.00	●

For better PID regulation, only PD or P adjustment is needed sometimes, while integral adjustment is not needed. For this reason, the EM730/EM730E series inverter has a special integral separation function. When the deviation between the PID setting and feedback is greater than the PID integral separation threshold (F09.20), the integral separation will be valid. That is, the integral (I) adjustment of the PID regulator will be suspended. To facilitate remote control, the input terminal function “42: process PID integration pause” can be used. But if the function code setting is invalid (F09.20=100.00), the input terminal function will not work, as detailed in Table 7-16.

Table 7-16 Description of Integral Separation Function

Method		Description
F09.20	DI(42)	F09.20: PID integral separation threshold; DI (42): Process PID integral pause
100.00%	--	The integral (I) is always valid.
0.00%		Depending on the relationship between $ e(k) $ and F09.20 as well as the status of the DI function
~	Invalid	If $ e(k) > F09.20$, the integral separation is valid.
99.99%	Valid	The integral separation is valid.

Function	Function code	Parameter description	Unit	Default	Attribute
----------	---------------	-----------------------	------	---------	-----------

code	name			setting	
F09.21	PID setting change time	0.000-30.000	s	0.000	●

The PID setting change time refers to the time required for the setting to change from 0.0% to 100.0%, similar to the acceleration and deceleration time function. When the PID setting changes, the actual PID setting will change linearly, thus reducing the impact of sudden changes on the system. Smoothing is invalid during the initial setting. The setting will change from the current feedback value during the start.

Function code	Function code name	Parameter description	Unit	Default setting	Attribute
F09.22	PID feedback filtering time	0.000-30.000	s	0.000	●
F09.23	PID output filtering time	0.000-30.000	s	0.000	●

F09.22 is used to filter the PID feedback. This is helpful to reduce the impact of interference on the feedback, but will cause the decline of the response performance of the process closed-loop system.

F09.23 is used to filter the PID output. This is helpful to reduce the sudden changes in the output frequency of the inverter, but will also cause the decline of the response performance of the process closed-loop system.

Function code	Function code name	Parameter description	Unit	Default setting	Attribute
F09.24	Upper limit detection value of PID feedback disconnection	0.00-100.00; 100.00 = invalid feedback disconnection	%	100.00	●
F09.25	Lower limit detection value of PID feedback disconnection	0.00-100.00; 0.00 = invalid feedback disconnection	%	0.00	●
F09.26	Detection time of PID feedback disconnection	0.000-30.000	s	0.000	●

The function of PID feedback disconnection detection is to prevent galloping caused by feedback disconnection. Depending on the nature of the feedback sensor, the settings are different.

If the 0.0% type sensor is fed back at the time of disconnection, the lower limit of PID feedback disconnection detection (F09.25) needs to be set to an appropriate value. If the feedback amount is below the F09.25 setting and has been maintained for the PID feedback

disconnection detection time (F09.26), the PID feedback will be regarded disconnected. When the 100.0% type sensor is fed back at the time of disconnection, the upper limit of PID feedback disconnection detection (F09.24) needs to be set to an appropriate value. If the feedback amount is greater than the feedback amount and has been maintained for the time corresponding to F09.26, the PID feedback will be regarded disconnected.

- ★ Once the feedback sensor is determined, only the corresponding detection mode can be applied. The upper limit detection and lower limit detection cannot be enabled at the same time.

Function code	Function code name	Parameter description	Unit	Default setting	Attribute
F09.27	PID sleep control options	0: Invalid 1: sleep at zero speed 2: sleep at lower frequency limit 3: sleep with tube sealed		0	●
F09.28	Sleep action point	0.00-100.00 (100.00 corresponds to the PID setting feedback range)	%	100.00	●
F09.29	Sleep delay time	0.0 - 6500.0	s	0.0	●
F09.30	Wake-up action point	0.00-100.00 (100.00 corresponds to the PID setting feedback range)	%	0.00	●
F09.31	Wake-up delay time	0.0 - 6500.0	s	0.0	●

When the output value and feedback value tend to be stable or the controlled quantity is within the allowable range on some occasions or at a certain moment, and the output is not allowed, the sleep status can be applied for a short time. If the controlled quantity is beyond the control range, the inverter will be awakened and generate the output. These steps will be repeated to make the controlled quantity within the allowable range and also save the energy. The detailed function description is shown in Table 7-17.

Table 7-17 Description of Sleep/Wake-up Function

Method		Description
Mode of action	State	
Positive action (e.g. constant	Normal work	Judgment of the sleep conditions: If the Feedback is greater than the sleep action point (F09.28) (necessary condition: the feedback pressure must be greater than or equal to the set pressure during restart after the stop or sleep), or the output frequency of the

pressure control)		inverter reaches the lower limit, causing the failure to continue to decelerate (due to the lower frequency limit or lower output limit of the inverter), and these conditions have been met and maintained to the sleep delay time (F09.29), the sleep status will be enabled. ★: The PID continues the output during the delay period. The output depends on the function code after the delay period.
	Sleep status	Judgment of the wake-up conditions: If the Feedback is less than or equal to the value of the wake-up action point (F09.30), and this has been maintained for the wake-up delay time (F09.31), the sleep status will be disabled. ★: The output depends on the function code during the delay period; and the PID can continue normal output after the delay period.
Negative action (e.g. constant temperature control)	Normal work	Judgment of the sleep conditions: If the Feedback is less than the sleep action point (F09.28) (necessary condition: the feedback pressure must be lower than or equal to the set pressure during restart after the stop or sleep), or the output frequency of the inverter reaches the lower limit, causing the failure to continue to decelerate (due to the lower frequency limit or lower output limit of the inverter), and these conditions have been met and maintained to the sleep delay time (F09.29), the sleep status will be enabled. ★: The PID continues the output during the delay period. The output depends on the function code after the delay period.
	Sleep status	Judgment of the wake-up conditions: If the Feedback is greater than or equal to the value of the wake-up action point (F09.30), and this has been maintained for the wake-up delay time (F09.31), the sleep status will be disabled. ★: The output depends on the function code during the delay period; and the PID can continue normal output after the delay period.

Suggestion: F09.28 (sleep action point) is greater than or equal to F09.30 (wake-up action point) during the positive action, and less than or equal to F09.30 (wake-up action point) during the negative action.

Function code	Function code name	Parameter description	Unit	Default setting	Attribute
F09.32	Multi-segment PID setting 1	0.0 to PID setting feedback range F09.03		0.0	●
F09.33	Multi-segment PID setting 2	0.0 to PID setting feedback range F09.03		0.0	●

F09.34	Multi-segment PID setting 3	0.0 to PID setting feedback range F09.03		0.0	●
--------	--------------------------------	---	--	-----	---

PID settings are determined in conjunction with the setting of the function code F09.00. The EM730/EM730E series inverter has a multi-segment PID setting function, and its switching conditions are mainly dependent on the input functions “15: multi-segment PID terminal 1” and “16: multi-segment PID terminal 2”, as detailed in Table 7-16.

Table 7-18 Details of Multi-segment PID Setting Function

Method			Setting	Scope	PID Setting
16	15	F09.00			
Invalid	Invalid	0	F09.01	0.0 - F09.03	0.00% - 100.00%
		1	AI1	-100.00% - 100.00%	-100.00% - 100.00%
		2	AI2	-100.00% - 100.00%	-100.00% - 100.00%
		6	485	-100.00% - 100.00%	-100.00% - 100.00%
Invalid	Valid	--	F09.32	0.0 - F09.03	0.00% - 100.00%
Valid	Invalid	--	F09.33	0.0 - F09.03	0.00% - 100.00%
Valid	Valid	--	F09.34	0.0 - F09.03	0.00% - 100.00%

Function code	Function code name	Parameter description	Unit	Default setting	Attribute
F09.35	Upper limit of feedback voltage	Lower limit of feedback voltage to 10.00	V	10.00	●
F09.36	Lower limit of feedback voltage	0.00 to upper limit of feedback voltage	V	0.00	●

The upper and lower limits of the feedback voltage can be used for automatic material cutoff detection in winding applications. They represent the upper and lower limits of material cutoff, respectively. Due to the particularity of winding applications, F09.35 and F09.36 can be used to reflect the real sensor boundaries, which is more conducive to the system stability.

Function code	Function code name	Parameter description	Unit	Default setting	Attribute
F09.37	Options of integral action within the set change time of PID	0: Always calculate the integral term 1: Calculate the integral term after the F09.21 set time is reached 2: Calculate the integral term when the error is less than F09.38		0	●
F09.38	Input deviation of integral action within the set change time of PID	0.00-100.00	%	30.00	●

F09.37=0: always calculate the integral term

This function code does not affect the integral action.

F09.37=1: calculate the integral term after the F09.21 set time is reached

The integral is unavailable within the first change period (F09.21) after startup.

F09.37=2: calculate the integral term when the error is less than F09.38

The integral is unavailable within the first change period (F09.21) after startup. However, the integral will be enabled again if the error is less than F09.38 within this period.

Function code	Function code name	Parameter description	Unit	Default setting	Attribute
F09.39	Wake-up option	0: target pressure F09.01* coefficient of wake-up action point 1: Wake-up action point (F09.30)		0	○
F09.40	Coefficient of wake-up action point	0.0-100.0 (100% corresponds to PID setting)	%	90.0	●

F09.39=0: target pressure F09.01* coefficient of wake-up action point

F09.40* preset

F09.39=1: wake-up action point (F09.30)

The PID will wake up if the value is less than the wake-up point (F09.30) and kept for the wake-up delay time (F09.31).

Function code	Function code name	Parameter description	Unit	Default setting	Attribute
F09.41	Pipeline network alarm overpressure	0.0 to pressure sensor range F09.03	%	90.0	●
F09.42	Overpressure protection time	0-3600 (0: invalid)	bar	6	●

It is dedicated to the water pump application macro. When the overpressure of the pipeline network reaches the value of F09.41 and kept for the set time (F09.42), the E57 pipeline network overpressure protection will be reported.

Function code	Function code name	Parameter description	Unit	Default setting	Attribute
F09.43	PID reverse limit	0: no limit 1: limit		0	○

It is dedicated to the straight wire drawing machine of the winding and unwinding application micro. When F27.00 is set to the option 3 (straight wire drawing machine) and the feedback

signal is the maximum value for a long time after startup, the system will be adjusted by PID to the negative output.

F09.43=0: No limit

When the output is reduced to 0, it will not be limited and may continue to decrease.

F09.43=1: limit

When the output is reduced to 0, it will be limited and not continue to decrease.

7.11 Communication Function Parameter Group of F10 Group

The EM730/EM730E series inverter supports the RTU format Modbus protocol, and the “single-master multi-slave” communication network with RS-485 bus.

Function code	Function code name	Parameter description	Unit	Default setting	Attribute
F10.00	Local Modbus communication address	1-247; 0: broadcast address		1	○

For the entire communication network, the inverter as a slave must have its own unique address. Its setting range is 1 to 247. That is, a network supports 247 slave stations at most.

- ★ 0 is the broadcast address, which does not need to be set. All slave inverters can be recognized.

The slaves and hosts attached to the same network must follow the same sending and receiving principles (e.g. baud rate, data format, and protocol format) to ensure normal communication. Hence, there are three corresponding function codes, i.e. F10.01 (baud rate), F10.02 (data format) and F10.10 (protocol format, Modbus-RTU protocol by default for the EM730/EM730E series inverter). The devices connected to the network must have the same settings.

Function code	Function code name	Parameter description	Unit	Default setting	Attribute
F10.01	Baud rate of Modbus communication	0:4800 1:9600 2:19200 3:38400 4:57600 5:115200	bps	1	○

During the communication based on the Modbus-RTU protocol, the EM730/EM730E series inverter supports six different baud rates in bps (bit/s). Take F10.01=9600bps as an example. It means that data is transmitted at a rate of 9600bits per second. By default, each byte consists of valid 8-bit data (such as 0x01). When 10-bit data needs to be transmitted in the actual

situation, the transmission time is about 1.04ms (approximately 1.04167ms=10bit/9600bps).

Function code	Function code name	Parameter description	Unit	Default setting	Attribute
F10.02	Modbus data format	0: 1-8-N-1 (1 start bit + 8 data bits + 1 stop bit) 1: 1-8-E-1 (1 start bit + 8 data bits + 1 even parity check bit + 1 stop bit) 2: 1-8-O-1 (1 start bit + 8 data bits + 1 odd parity check bit + 1 stop bit) 3: 1-8-N-2 (1 start bit + 8 data bits + 2 stop bits) 4: 1-8-E-2 (1 start bit + 8 data bits + 1 even parity check bit + 2 stop bits) 5: 1-8-O-2 (1 start bit + 8 data bits + 1 odd parity check bit + 2 stop bits)		0	○

In the UART transmission, the data usually consists of a start bit, valid data (8 bits by default), check bit (optional), and a stop bit. The EM730/EM730E series inverter supports six data formats according to the Modbus-RTU combinations in communication.

Start Bit	Valid Data								Check Bit	Stop Bit
1	7	6	5	4	3	2	1	0	N/O/E	1

If F10.02=0, it means that the current data consists of one start bit + eight data bits + no check bit + one stop bit.

★ N (NONE): no parity; E (EVEN): even parity; O (ODD), odd parity.

In order to meet different needs, the inverter also supports communication timeout and response delay during the communication based on the Modbus protocol.

Function code	Function code name	Parameter description	Unit	Default setting	Attribute
F10.03	Modbus communication timeout	0.0 to 60.0; 0.0: invalid (also valid for master-slave mode)	s	0.0	●

As shown in Fig. 7-30, the communication time interval Δt is defined as the period from the previous reception of valid data frames by the slave station (inverter) to next reception of valid data frames. If Δt is greater than the set time (depending on the function code F10.03; this function is invalid if set to 0), it will be regarded communication timeout.

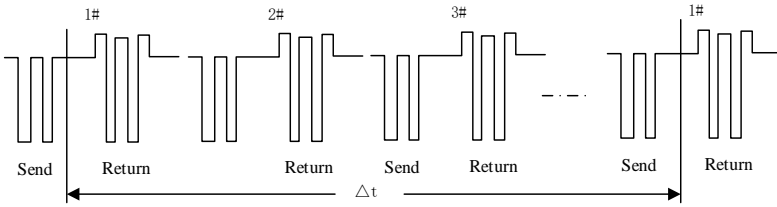

Fig. 7-30 Schematic Diagram of Communication Timeout

Example of this function: If the master station must send data to a slave station (e.g. #1) within a certain period, you can use the communication timeout function of #1 slave station and set F10.03>T. The communication timeout protection will not be triggered during normal communication. However, if the master station does not send data to #1 slave station within the specified time T, and this lasts for more than the set value of F10.03, a communication protection (E #5) will be reported. Once informed of the “communication protection of #1 slave station”, the staff can conduct troubleshooting.

★ The set value of F10.03 must be greater than the set time T, but must not be too large, in order to avoid adverse effects arising from too long operation in the protection status.

★ F10.03 should be set to be invalid under normal circumstances. This parameter will be set only in the continuous communication system to monitor the communication.

Function code	Function code name	Parameter description	Unit	Default setting	Attribute
F10.04	Modbus response delay	1 - 20	ms	2	●

The response delay (t_{wait2}) is defined as the time interval from the reception of the valid data frame 1 by the inverter to data parsing and return. To ensure the stable operation of the protocol chip, the response delay should be set within 1-20ms (it must not be set to 0). **If the communication data involves EEPROM operation, the actual response delay time will be extended, i.e. “EEPROM operation time + F10.04”.**

1: valid data frame: sent by the external master station to inverter, in which the function code, data length and CRC are correct.

Fig. 7-31 shows the data sending segment (t_{send}), sending end segment (t_{wait1}), 75176-to-sending wait segment (t_{wait2}), data return segment (t_{return}), and 75176-to-receiving wait segment (t_{wait3}).

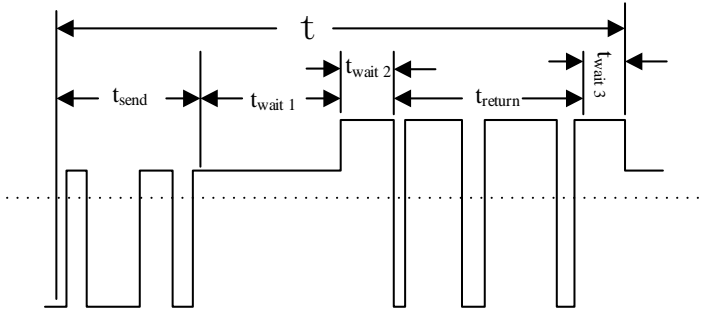

Fig. 7-31 Timing Parse Diagram of Complete Data Frame

Function code	Function code name	Parameter description	Unit	Default setting	Attribute
F10.05	Options of master-slave communication function	0: Invalid 1: valid		0	○
F10.06	Master-slave options	0: slave 1: host (Modbus protocol broadcast transmission)		0	○
F10.07	Data sent by host	0: output frequency 1: set frequency 2: output torque 3: set torque 4: PID setting 5: output current		1	○
F10.08	Proportional factor of slave reception	0.00-10.00 (multiple)		1.00	●
F10.09	Host sending interval	0.000-30.000	s	0.200	●

The EM730/EM730E series inverter supports the master-slave communication function. That is, one inverter works as the host and others as slaves. The slaves work according to the command sent by the host, so that these inverters can work synchronously.

- The inverter used as the host is set as follows:

F10.05=1: enable the master-slave communication function;

F10.06=1 or 2: select the current inverter as the host (only one inverter can be set as the host in a network);

F10.07: select the variable to be synchronized, such as the output current (set F10.07=5).

- The inverter is used as the slave is set as follows:

F10.05=1: enable the master-slave communication function;

F10.06=0: select the current inverter as the slave;

Select one setting as the communication setting. If F09.00=6 is set and the process PID is set separately (F00.05=10, F00.06=1), the slave inverter will be set to the host output current for PID adjustment.

You can set the receiving proportional coefficient (F10.08) to determine how the slave inverter receives data. If F10.08=0.80 is set, the final application data is “Recv (received data) * 0.80 (F10.08)”.

Function code	Function code name	Parameter description	Unit	Default setting	Attribute
F10.56	Options of 485 EEPROM writing	0-10: default operation (for commissioning) 11: writing not triggered (available after commissioning)		0	○

For the application “PLC controller/HMI + inverter”, you can set F10.56=11 after debugging. Then all write data of PLC communication will not be stored, which can avoid damage to the memory.

If you need parameter settings and power-down storage, set F10.56=0 first.

Function code	Function code name	Parameter description	Unit	Default setting	Attribute
F10.59	SCI response option	0: Reply to both read and write commands 1: Reply to write commands only 2: No reply to both read and write commands		0	○

F10.59=0: During the Modbus communication with the upper computer, both read and write parameters will be returned to the upper computer.

F10.59=1: During the Modbus communication with the upper computer, the read parameters will be returned to the upper computer, while the write parameters will not.

F10.59=2: During the Modbus communication with the upper computer, both read and write parameters will not be returned to the upper computer. This can improve the communication efficiency.

7.12 User-selected Parameter Group of F11 Group

The keyboard of the EM730/EM730E series inverter supports the user-selected function. First, the user should select specific function codes by setting the parameters of the F11 group. Then the user-selected mode (--U--, as detailed in 4.2.2) can be enabled. The selected function codes can be switched cyclically by turning the digital potentiometer key . This function is mainly used where less than 32 specific function codes are involved, which can avoid the trouble caused by too many function codes.

Function code	Function code name	Parameter description	Unit	Default setting	Attribute
F11.00	User-selected parameter 1	The displayed content is Uxx.xx, which means that the Fxx.xx function code is selected. If the F11.00 function code is enabled, the keyboard will display U00.00, indicating the first optional parameter F00.00.		U00.00	●
F11.01	User-selected parameter 2			U00.01	●
F11.02	User-selected parameter 3			U00.02	●
F11.03	User-selected parameter 4			U00.03	●
F11.04	User-selected parameter 5			U00.04	●
F11.05	User-selected parameter 6			U00.07	●
F11.06	User-selected parameter 7			U00.14	●
F11.07	User-selected parameter 8			U00.15	●
F11.08	User-selected parameter 9			U00.16	●
F11.09	User-selected parameter 10			U00.18	●
F11.10	User-selected parameter 11			U00.19	●
F11.11	User-selected parameter 12			U00.29	●
F11.12	User-selected parameter 13			U02.00	●
F11.13	User-selected parameter 14			U02.01	●
F11.14	User-selected parameter 15			U02.02	●
F11.15	User-selected parameter 16			U03.00	●

F11.16	User-selected parameter 17		U03.02	●
F11.17	User-selected parameter 18		U03.21	●
F11.18	User-selected parameter 19		U04.00	●
F11.19	User-selected parameter 20		U04.20	●
F11.20	User-selected parameter 21		U05.00	●
F11.21	User-selected parameter 22		U05.03	●
F11.22	User-selected parameter 23		U05.04	●
F11.23	User-selected parameter 24		U08.00	●
F11.24	User-selected parameter 25		U19.00	●
F11.25	User-selected parameter 26		U19.01	●
F11.26	User-selected parameter 27		U19.02	●
F11.27	User-selected parameter 28		U19.03	●
F11.28	User-selected parameter 29		U19.04	●
F11.29	User-selected parameter 30		U19.05	●
F11.30	User-selected parameter 31		U19.06	●
F11.31	User-selected parameter 32		U19.12	●



F11.00=U00.00, indicating that the first user-selected parameter is the function code F00.00. The function codes in the user-selected mode of the keyboard are switched according to the function code order from F11.00 to F11.31.

7.13 Keyboard and Display Function Parameter Group of F12 Group

Function code	Function code name	Parameter description	Unit	Default setting	Attribute
F12.00	M.K multi-function key options	0: no function 1: forward jog 2: reverse jog 3: forward/reverse switching 4: quick stop 5: free stop 6: cursor movement to the left		1	○

 is a multi-function key, of which the function can be performed by setting the function code F12.00. If F12.00=0, this key has no effect when pressed. For other settings, the corresponding effects will be obtained when this key is pressed.

Function code	Function code name	Parameter description	Unit	Default setting	Attribute
F12.01	Options of stop function of STOP key	0: valid only in keyboard control 1: with all command channels valid		1	○

According to the setting of the function code F00.02 (command source option), the command sources are divided into the keyboard, terminal and communication. If the terminal is selected as the current command source, the Run  and Stop  key on the keyboard will be unavailable. In more dangerous cases, however, the fastest way is to stop the inverter via the Stop  key on the keyboard to resolve dangers. It is the most convenient to use the keyboard to stop the inverter during normal operation. Therefore, the function code “F12.01: stop function options of the STOP key” is added. In addition, the STOP key is always valid by default.

★ It is recommended not to modify this parameter. If necessary, please set it carefully.

Function code	Function code name	Parameter description	Unit	Default setting	Attribute
F12.02	Parameter locking	0: do not lock 1: reference input not locked 2: all locked, except for this function code		0	●

In order to avoid unnecessary danger caused by keyboard operation or misoperation of

non-workers, the keyboard has a parameter locking function. The current function code is unlocked by default, and all function codes can be set. After the function code is debugged according to the working conditions, the parameters can be locked.

- 1: reference input not locked



In the lock mode, all function codes cannot be modified, except this function code and those with reference input properties. Specific function codes with parameter input properties are shown in Table 7-19:

Table 7-19 List of Function Codes with Reference Input Properties

Function code	Function code name	Function code	Function code name
F00.07	Digital frequency setting	F08.11	Multi-segment speed 12
F08.00	Multi-segment speed 1	F08.12	Multi-segment speed 13
F08.01	Multi-segment speed 2	F08.13	Multi-segment speed 14
F08.02	Multi-segment speed 3	F08.14	Multi-segment speed 15
F08.03	Multi-segment speed 4	F13.02	Digital torque setting
F08.04	Multi-segment speed 5	F09.01	Digital PID setting
F08.05	Multi-segment speed 6	F09.32	Multi-segment PID setting 1
F08.06	Multi-segment speed 7	F09.33	Multi-segment PID setting 2
F08.07	Multi-segment speed 8	F09.34	Multi-segment PID setting 3
F08.08	Multi-segment speed 9	F13.03	Multi-segment torque 1
F08.09	Multi- speed 10	F13.04	Multi-segment torque 2
F08.10	Multi-segment speed 11	F13.05	Multi-segment torque 3

- 2: all locked, except for this function code

In the lock mode, all function codes cannot be set except this function code. This mode is mostly used when it is not necessary to set parameters after debugging. We can only perform running, stop and parameter monitoring in this mode.

We can press the ESC key  to enable the monitoring mode (see 4.4). When the inverter is in the protection status, you can directly press the right shift key  to switch the current protection type and the output frequency, output current, output voltage, running status and working time during the protection.

Operation Monitoring: press the right shift key  to display the parameters in cycles. The function codes F12.04 to F12.08 are used to select the parameters to be displayed in the cycle display queue. The selected items basically correspond to the monitoring parameter group of the F18 group, so you can directly view the current values of all parameters in the F18 group.

This function is mainly conducive to parameter display, especially during operation.

By default, several common items are included in the cycle display queue, including the output frequency (F18.00), set frequency (F18.01), output current (F18.06), output voltage (F18.08) and DC bus voltage (F18.09). Please set the corresponding bit to 1 to select other display parameters and 0 to hide the selected parameters.

- ★ Some bits of the function codes for display parameter selection are reserved. Please set them carefully.

Function code	Function code name	Parameter description	Unit	Default setting	Attribute
F12.03	Parameter copying	0: No operation 1: parameter upload to keyboard 2: Download parameters to inverter		0	○

Where several inverters need to run with the same parameter settings, we can debug one inverter first, set it to F12.03=1 to upload the set parameters to the keyboard for temporary storage and finally set the other inverters to F12.03=2 to download the parameters to these inverters. This function can be applied to quickly set the parameters of several inverters. Even if some parameter settings are different, this function can be applied to set multiple function codes before setting by other means.

Function code	Function code name	Parameter description	Unit	Default setting	Attribute
F12.09	Load speed display coefficient	0.01~600.00		30.00	●

The inverter output is mostly displayed in the frequency form. To set the current load speed (F18.13), you can change the current parameter from frequency output to speed output based on the actual working conditions, so that F18.14 displays the current load speed correctly.

If F12.09=30.00 (related to the number of motor pole pairs, transmission ratio and the like), the output frequency (0.00 to 50.00 Hz) corresponds to the load speed (0 to 1500 rpm).

Function code	Function code name	Parameter description	Unit	Default setting	Attribute
F12.10	UP/DOWN acceleration and deceleration rate	0.00: automatic rate 0.01 - 500.00	Hz/s	5.00	○
F12.11	Options of UP/DOWN offset	0: do not clear		0	○

	clearing	1: clear in non-running state 2: clear when UP/DOWN invalid			
F12.12	Options of UP/DOWN power-down saving of offset	0: do not save 1: save (valid after the offset is modified)		1	○

The UP/DOWN functions are mainly divided into the keyboard UP/DOWN and terminal UP/DOWN, which are handled separately and can be enabled at the same time.

- Keyboard UP/DOWN: It is valid in the Level 0 monitoring menu. When the current setting is not the digital potentiometer setting, the UP function can be performed by forward spinning of the digital potentiometer via the keyboard and the DOWN function by reverse spinning.
- During the forward or reverse spinning of the digital potentiometer under the monitoring menu, the offset frequency will increase/decrease at the rate of F12.10, the keyboard will display “F18.01: set frequency”, and the final frequency will be the set frequency plus offset frequency. The keyboard will have the normal display 2 s after the key is released.
- Terminal UP/DOWN: After the digital input port is set to the corresponding function, terminal control will be enabled.

When the UP/DOWN terminal is valid, the offset frequency will increase/decrease at the rate of F12.10 and the final frequency is the set frequency plus offset frequency. The display content of the keyboard remains unchanged during this period.

- ★ When the keyboard UP and terminal DOWN are valid at the same time, or the keyboard DOWN and terminal UP are valid at the same time, despite of the same acceleration and deceleration rates, the offset frequency will fluctuate because of different valid moments. This is a normal phenomenon.

Function code	Function code name	Parameter description	Unit	Default setting	Attribute
F12.13	Power meter resetting	0: do not clear 1: clear		0	●

The EM730/EM730E series inverter has a watt-hour meter function (see the description of the function codes F18.18 and F18.19). The user can set the current function code to 1 to clear the current count.

Function code	Function code name	Parameter description	Unit	Default setting	Attribute
F12.14	Restoration of default setting	0: No operation 1: restoration of factory defaults (excluding the motor parameters, inverter parameters, manufacturer parameters, running and power-on time record)		0	○

You can set this parameter to 1 to restore the default settings of all parameters, except the motor parameters (F01 group), inverter parameters, manufacturer parameters, power-on time (F12.15/16) and operating time (F12.17, 18).

★ This operation is irreversible. Please set it carefully.

Function code	Function code name	Parameter description	Unit	Default setting	Attribute
F12.15	Cumulative power-on time (h)	0 - 65535	h	0	×
F12.16	Cumulative power-on time (min)	0 - 59	min	0	×

F12.15 and F12.16 are used together to check the cumulative power-on time of the inverter from delivery to the current moment (you only need to power on the inverter). The cumulative power-on time is accurate to one minute and nearly 65536 hours (about 7.5 years) at most.

If F12.15=50 and F12.16=33, it means that the current inverter has been powered on for 2 days, 2 hours and 33 minutes.

★ This parameter can be viewed only and cannot be changed or cleared.

Function code	Function code name	Parameter description	Unit	Default setting	Attribute
F12.17	Cumulative running time (h)	0 - 65535	h	0	×
F12.18	Cumulative running time (min)	0 - 59	min	0	×

F12.17 and F12.18 are used together to check the cumulative operating time of the inverter from delivery to the current moment (the inverter should be in the running status). The cumulative power-on time is accurate to one minute and nearly 65536 hours (about 7.5 years) at most.

If F12.17=47 and F12.18=39, it means that the current inverter has been running for 1 day, 23 hours and 39 minutes.

★ This parameter can be viewed only and cannot be changed or cleared.

Function code	Function code name	Parameter description	Unit	Default setting	Attribute
F12.19	Rated power of inverter	0.40 - 650.00	kW	Depending on the motor type	×
F12.20	Rated voltage of inverter	60 - 690	V	Depending on the motor type	×
F12.21	Rated current of inverter	0.1 - 1500.0	A	Depending on the motor type	×

It is used to view the rated power, rated voltage and rated current of the current inverter.

★ This parameter is can be viewed only and cannot be changed.

Function code	Function code name	Parameter description	Unit	Default setting	Attribute
F12.22	Performance software S/N 1	XXX.XX		XXX.XX	×
F12.23	Performance software S/N2	XX.XXX		XX.XXX	×
F12.24	Functional software S/N 1	XXX.XX		XXX.XX	×
F12.25	Functional software S/N 2	XX.XXX		XX.XXX	×
F12.26	Keyboard software serial number 1	XXX.XX		XXX.XX	×
F12.27	Keyboard software serial number 2	XX.XXX		XX.XXX	×

It is used to view the software version of the current inverter.

★ This parameter is can be viewed only and cannot be changed.

Function code	Function code name	Parameter description	Unit	Default setting	Attribute
F12.33	Running status display parameter 1 of Mode 1 (LED stop status display parameter 5)	0.00 - 99.99		18.00	●
F12.34	Running status display parameter 2 of Mode 1 (LED stop status display parameter 1)	0.00 - 99.99		18.01	●
F12.35	Running status display parameter	0.00 - 99.99		18.06	●

	3 of Mode 1 (LED stop status display parameter 2)				
F12.36	Running status display parameter 4 of Mode 1 (LED stop status display parameter 3)	0.00 - 99.99		18.08	●
F12.37	Running status display parameter 5 of Mode 1 (LED stop status display parameter 4)	0.00 - 99.99		18.09	●

F12.32=0: monitoring mode 0. The LED switching display and LCD small-line (7-line) display are dependent on the settings of the function codes F12.04 to F12.08. For the selected function codes, please refer to their parameter description.

F12.32=1: monitoring mode 1. The LED switching display and LCD small-line (7-line) display are dependent on the settings of the function codes F12.33 to F12.37. You can select any function code. F12.33=18.00 means that the function code F18.00 is displayed.

Function code	Function code name	Parameter description	Unit	Default setting	Attribute
F12.41	Options of UP/DOWN zero crossing	0: prohibit zero crossing 1: allow zero crossing		0	○

The UP/DOWN function is valid. When F12.41=0, the UP/DOWN function can reduce the output frequency of the inverter to 0 without reversing. When F12.41=1, the UP/DOWN function can reduce the output frequency of the inverter to 0, followed by reverse running of the motor.

For the digital potentiometer setting, see the setting of the main frequency source A.

Function code	Function code name	Parameter description	Unit	Default setting	Attribute
F12.42	Frequency setting of digital potentiometer	0.00 to maximum frequency F00.16	Hz	0.00	×
F12.43	Digital potentiometer torque setting	0.00-[Digital torque setting F13.02]	%	0.0	×

For the digital potentiometer setting, see the setting of the main frequency source A.

F12.45	UP/DOWN function options of keyboard	D7	D6	D5	D4	D3	D2	D1	D0	00000	○
		*	*	*	Communication	High-speed pulse	Analog quantity	Digital frequency	Multi-segment speed		
		0: Invalid 1: valid									

Select the up/down function in the corresponding frequency setting mode.

If the default frequency source is the digital frequency:

In case of F12.45 = 00000, the UP/DOWN function is unavailable, and the set frequency cannot be changed by the digital potentiometer in the monitoring status.

In case of F12.45 = 00010, the UP/DOWN function is available, and the set frequency of the main channel can be changed by the digital potentiometer in the monitoring status.

7.14 Torque Control Parameter Group of F13 Group

Function code	Function code name	Parameter description	Unit	Default setting	Attribute
F13.00	Speed/torque control options	0: Speed control 1: Torque control		0	○

F13.00=0: speed control

The control mode is speed input, and the input is frequency.

F13.00=1: torque control

The input control mode is torque input, and the input is the percentage of the rated torque current of the motor. This is valid only in the mode of speed sensorless vector control (SVC), i.e. F00.01=1.

The final control mode is also related to the function terminals “29: torque control prohibition” and “28: speed control/torque control switching” as detailed below Table 7-18.

Table 7-20 Details of Final Control Mode of Inverter

29: torque control prohibition	28: speed control/torque control switching	F13.00	Final control
Valid	*	*	Speed control
Invalid	Valid	0	Torque control
		1	Speed control
	Invalid	0	Speed control
		1	Torque control

Function code	Function code name	Parameter description	Unit	Default setting	Attribute
F13.01	Options of torque setting source	0: digital torque setting F13.02 1: AI1 2: AI2 3: retention 4: retention 5: high frequency pulse input (X5) 6: Communication setting (Full range of the items 1-6, corresponding to F13.02 digital torque setting) 7: retention 8: digital potentiometer setting		0	○
F13.02	Digital torque setting	-200.0 to 200.0 (100.0 = the rated torque of motor)	%	100.0	●

F13.01=0: digital torque setting F13.02

The torque depends on F13.02.

F13.01=1:AI1

F13.01=2:AI2

The torque is dependent on AI (percentage) * F13.02.

F13.01=5: High-frequency pulse input (X5)

The torque depends on HDI (percentage)*F13.02.

For the details of AI1-AI2 and X5, refer to the F00.04 description. They have the same meaning. 100.00% is the percentage to the set value of F13.02 (digital torque setting).

F13.01=6: communication setting

The torque depends on the communication and the like.

- If the master-slave communication (F10.05=1) is enabled and the inverter works as the slave (F10.06=0), the specific feedback percentage is “700FH (master-slave communication setting) * F10.08 (slave receiving proportional coefficient)”, and the 700FH data range is -100.00% to 100.00%, as detailed in Table 12-31.

For the general communication (F10.05=0), the specific setting percentage is “7003H (torque communication setting) * F13.02 (digital torque setting)”, and the 7003H data range is -200.00% to 200.00%, as detailed in Table 12-31.

F13.01=8: digital potentiometer setting

In the torque mode, the torque is directly set by the digital potentiometer. See F12.43 for the specific value.

Function code	Function code name	Parameter description	Unit	Default setting	Attribute
F13.03	Multi-segment torque 1	-200.0 - 200.0	%	0.0	●
F13.04	Multi-segment torque 2	-200.0 - 200.0	%	0.0	●
F13.05	Multi-segment torque 3	-200.0 - 200.0	%	0.0	●

For diversified torque applications, the EM730/EM730E series inverter supports the multi-segment torque function. Specifically, the input terminal functions “17: multi-segment torque terminal 1” and “18: multi-segment torque terminal 2” need to be set. See the instruction Table 7-21 for details.

Table 7-21 Combination of Multi-segment Torque Command and Multi-segment Torque Terminal

18: multi-segment torque terminal 2	17: multi-segment torque terminal 1	Number of Segments	Torque setting
Invalid	Invalid	Multi-segment torque 1	Depending on the F13.01 setting
Invalid	Valid	Multi-segment torque 2	F13.03
Valid	Invalid	Multi-segment torque 3	F13.04
Valid	Valid	Multi-segment torque 4	F13.05

Function code	Function code name	Parameter description	Unit	Default setting	Attribute
F13.06	Torque control acceleration and deceleration time	0.00 - 120.00	s	0.05	●

The motor speed can be changed gently by setting the acceleration and deceleration time of torque control.

F13.06 represents the time for the torque current to rise from 0 to the rated torque current or fall from the rated current to 0.

Function code	Function code name	Parameter description	Unit	Default setting	Attribute
F13.08	Upper frequency limit options of torque control	0: set by F13.09 1: AI1 2: AI2 3: retention		0	○

		4: retention 5: high frequency pulse input (X5) 6: communication percentage setting 7: direct communication setting			
F13.09	Upper frequency limit of torque control	0.50 to maximum frequency F00.16	Hz	50.00	●
F13.10	Upper frequency limit offset	0.00 to maximum frequency F00.16	Hz	0.00	●
F13.18	Reverse speed limit options	0 - 100	%	100	●
F13.19	Speed priority enabling of torque control	0: Disable 1: Enable		1	●

F13.08=0: depending on F13.09

The upper frequency limit depends on F13.09 during torque control.

F13.08=1:AI1

F13.08=2:AI2

The upper frequency limit in torque control is AI (percentage) * F13.09.

For the details of AI1 and AI2, refer to the F00.04 description. They have the same meaning. 100.00% is the percentage to the set value of F13.09 (upper frequency limit of torque control).

F13.08=5: High-frequency pulse input (X5)

The upper frequency limit in torque control is HDI (percentage) * F13.09.

For the details of AI1-AI2 and X5, refer to the F00.04 description. They have the same meaning. 100.00% is the percentage to the set value of F13.09(upper limit frequency of torque control).

F13.08=6 or 7: communication setting

The torque depends on the communication and the like.

- If the master-slave communication (F10.05=1) is enabled and the inverter works as the slave (F10.06=0), the upper frequency limit is “700FH (master-slave communication setting) * F10.08 (slave receiving proportional coefficient) * F00.18 (upper frequency limit)”, and the 700FH data range is -100.00% to 100.00%, as detailed in Table 12-31.

● For general communication (F10.05=0):

- a、 F13.08=6: the upper frequency limit is “700BH (communication percentage setting of the upper frequency limit of torque control) * F13.09 (upper frequency limit of torque control)”;
- b、 F13.08=7: the upper frequency limit is “7018H (communication setting of the upper frequency limit of torque control)”.

The 700BH data range is 0.00% to 200.00%, and the 7018H data range is 0.00 to F00.16 (maximum frequency), as detailed in Table 12-31.

The upper frequency limit of torque control is used to set the maximum forward or reverse running frequency of the inverter in the torque control mode.

In the torque control mode, if the load torque is less than the output torque of the motor, the motor speed will rise continuously, and the maximum speed of the motor must be limited during torque control to prevent the mechanical system from galloping and other accidents; if the load exceeds the output torque of the motor and even the motor is drive to run reversely, the maximum operating load frequency of the motor is still restricted in the case of F13.19=1 and not restricted in the case of F13.19=0.

The upper frequency limit of reverse running is dependent on F13.09 * F13.18.

Example: The torque is set to be positive and the upper frequency limit of torque control is the AI1 analog input. When the AI1 analog input is positive, the upper frequency limit corresponding to the forward speed limit is AI1 (percentage) * F13.09 and that corresponding to the reverse speed limit is AI1 (percentage) * F13.09 * F13.18; and when the AI1 analog input is negative, the upper frequency limit corresponding to the forward speed limit is AI1 (percentage) * F13.09 * F13.18 and that corresponding to the reverse speed limit is AI1 (percentage) * F13.09.

Maximum operating frequency in torque control = upper frequency limit of torque control + offset of upper frequency limit (valid only when F13.08=1 to 5), but the maximum operating frequency is limited by the maximum frequency of F00.16.

Function code	Function code name	Parameter description	Unit	Default setting	Attribute
F13.11	Static friction torque	0.0-100.0	%	0.0	●

	compensation				
F13.12	Frequency range of static friction compensation	0.00 - 50.00	Hz	1.00	●
F13.13	Dynamic friction torque compensation	0.0-100.0	%	0.0	●

When the motor drives an object to move, it is necessary to overcome static/dynamic friction. You can set this group of parameters to enable the motor rotation at the specified torque while overcoming the inherent static/dynamic friction. The motor is mainly subject to static friction before rotation and dynamic friction after starting rotating. In short, the output performance of the motor is related to this group of parameters.

The specific description of this group of parameters is as follows: “when the actual frequency (estimate frequency in SVC) is less than or equal to the set value of F13.12, the output torque is the ‘set torque + F13.11 static friction torque compensation’; and when the actual frequency is greater than the set value of F13.12, the output torque is ‘set torque + F13.13 dynamic friction torque compensation’”. The larger the compensation value, the stronger the compensation force will be. The compensation percentage is equal to the torque setting percentage.

7.15 Parameter Group of Motor 2 of F14 group

The two motors of the EM730/EM730E series inverter can be switched. For the two motors, the motor nameplate parameters, encoder parameters and VF control or vector control parameters can be set separately, and the VF control or vector control can be selected independently. In addition, the parameters of the two motors can be tuned separately.

All motor parameters in the second group are included in the F14 group, and the function codes are defined the same as those in the first group. The function codes F14.00 to F14.34 correspond to F01.00 to F01.34, which are motor nameplate parameters, motor parameters and encoder parameters; the function code F14.35 corresponds to F00.01, which is used to select the motor drive mode; the function codes F14.36 to F14.76 correspond to F06.00 to F06.40, which are vector control parameters; and the function code F14.77 is used to select the acceleration/deceleration time of the motor 2. Only the parameters of F14.72 are described below. For the rest of the parameters, refer to the relevant parameters of the motor 1.

Function code	Function code name	Parameter description	Unit	Default setting	Attribute
F14.52	Stiffness coefficient of speed loop of motor 2	0~20		12	●

In the vector control mode, the dynamic speed response of the inverter is adjusted by changing the speed proportional gain (ASR_P) and speed integral time (ASR_T) of the speed PI regulator. The increase in ASR_P or decrease in ASR_T may accelerate the dynamic response of the speed loop. If ASR_P is too large or ASR_T is too small, however, the system may be over-tuned to cause oscillation.

<p>In case of any change in F14.52, the default settings of F14.36-F14.39 will change accordingly. The regulation intensity of the PI regulator for the speed of the motor 2 can be adjusted. There are 21 groups of parameters in total. The larger the set value of F14.52, the smaller the integral time is, and the more intense the speed PID regulation is. The smaller the set value</p>	Function code name	Parameter description	Unit	Default setting	Attribute
---	--------------------	-----------------------	------	-----------------	-----------

of F14.52, the weaker the speed PID regulation is. Function code					
F14.77	Acceleration/deceleration time options of motor 2	0: the same as motor 1 1: acceleration and deceleration time 1 2: acceleration and deceleration time 2 3: acceleration and deceleration time 3 4: acceleration and deceleration time 4		0	○

F14.77=0: the acceleration/deceleration time of the motor 2 is the same as that of the motor 1. For details, see the description of the function codes F15.03 to F15.09;

F14.77=1/2/3/4: the acceleration/deceleration time of the motor 2 is fixed as the acceleration/deceleration time 1/2/3/4, corresponding to the function codes F00.14, F00.15/F15.03, F15.04/F15.05, F15.06/F15.07 and F15.08, respectively.

Function code	Function code name	Parameter description	Unit	Default setting	Attribute
F14.78	Maximum frequency of motor 2	20.00~600.00	Hz	50	○
F14.79	Upper frequency limit of motor 2	Lower limit frequency F00.19 to maximum frequency F14.78	Hz	50	●

See F00.16 and F00.18

Function code	Function code name	Parameter description	Unit	Default setting	Attribute
F14.80	V/F curve setting of motor 2	0: straight line V/F 1: multi-point broken line V/F 2: 1.3-power V/F 3: 1.7-power V/F 4: square V/F 5: VF complete separation mode (Ud = 0, Uq = K * t = voltage of separation voltage source) 6: VF semi-separation		0	○

		mode ($U_d = 0, U_q = K * t = F/Fe * 2 * \text{voltage of separation voltage source}$)			
F14.81	Multi-point VF frequency F1 of motor 2	0.00 - F14.83	Hz	0.50	●
F14.82	Multi-point VF voltage V1 of motor 2	0.0~100.0 (100.0 = Rated voltage)	%	1.0	●
F14.83	Multi-point VF frequency F2 of motor 2	F14.81 - F14.85	Hz	2.00	●
F14.84	Multi-point VF voltage V2 of motor 2	0.0-100.0	%	4.0	●
F14.85	Multi-point VF frequency F3 of motor 2	F14.83 to rated frequency of motor (reference frequency)	Hz	5.00	●
F14.86	Multi-point VF voltage V3 of motor 2	0.0-100.0	%	10.0	●

See F05.00 to F05.06

Function code	Function code name	Parameter description	Unit	Default setting	Attribute
F14.87	Stop mode of motor 2	0: Slow down to stop 1: Free stop		0	○

See F04.19

7.16 Auxiliary Function Parameter Group of F15 Group

Function code	Function code name	Parameter description	Unit	Default setting	Attribute
F15.00	Jog frequency	0.00 to maximum frequency F00.16	Hz	5.00	●
F15.01	Jog acceleration time	0.00 - 650.00 (F15.13=0) 0.0 - 6500.0 (F15.13=1) 0 - 65000 (F15.13=2)	s	5.00	●
F15.02	Jog deceleration time	0.00 - 650.00 (F15.13=0) 0.0 - 6500.0 (F15.13=1) 0 - 65000 (F15.13=2)	s	5.00	●

As shown in Fig. 7-32, when the jog running command (FJOG/RJOG) is valid, the inverter will start running at the set frequency of F15.00; and when the jog running command is invalid, the inverter will be stopped according to the stop mode.

F15.01 and F15.02 are set as the acceleration and deceleration time during operation. Their values (e.g. 500) depend on the acceleration and deceleration time unit (F15.13), and have different meanings and ranges. For example, F15.13=0 means that the acceleration and deceleration time is 5.00s, and F15.13=1 means that the acceleration and deceleration time is 50.0s.

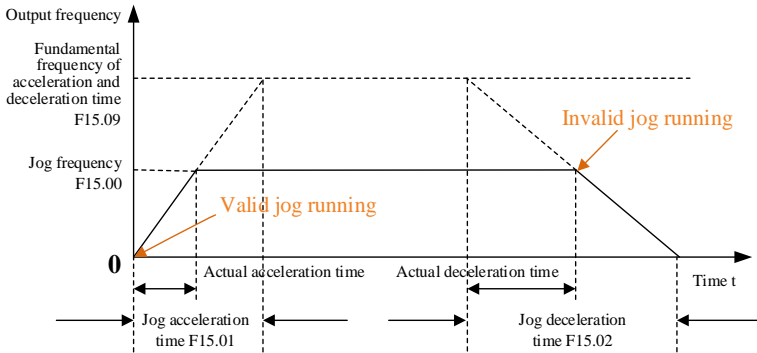

Fig. 7-32 Schematic Diagram of Jog Running

★: The separate set frequency and acceleration/deceleration time are applied in jog running, and not shared in normal running, but with the same physical meanings.

The triggering conditions of the jog running command vary depending on the control mode and valid conditions, as detailed in Table 7-22.

Table 7-22 Details of Jog Running Command

Command Source Option (F00.02)	Jog running command
1: Terminal control	Select the digital input terminal function “4: forward jog (FJOG)” or “5: reverse jog (RJOJ)”. By default, if the function terminal is valid, the jog running command will be valid; and if the function terminal is invalid, the jog running command will be invalid.
2: Communication control	If the host writes “0003H: JOG forward” or “0004: JOG reverse” to the register 7000H through the MODBUS protocol, the jog running command will be valid; if it writes “0007H: free stop”, the jog running command will be invalid.

Function code	Function code name	Parameter description	Unit	Default setting	Attribute
F15.03	Acceleration time 2	0.00 - 650.00 (F15.13=0) 0.0 - 6500.0 (F15.13=1) 0 - 65000 (F15.13=2)	s	15.00	●
F15.04	Deceleration time 2	0.00 - 650.00 (F15.13=0) 0.0 - 6500.0 (F15.13=1) 0 - 65000 (F15.13=2)	s	15.00	●
F15.05	Acceleration time 3	0.00 - 650.00 (F15.13=0) 0.0 - 6500.0 (F15.13=1) 0 - 65000 (F15.13=2)	s	15.00	●
F15.06	Deceleration time 3	0.00 - 650.00 (F15.13=0) 0.0 - 6500.0 (F15.13=1) 0 - 65000 (F15.13=2)	s	15.00	●
F15.07	Acceleration time 4	0.00 - 650.00 (F15.13=0) 0.0 - 6500.0 (F15.13=1) 0 - 65000 (F15.13=2)	s	15.00	●
F15.08	Deceleration time 4	0.00 - 650.00 (F15.13=0) 0.0 - 6500.0 (F15.13=1) 0 - 65000 (F15.13=2)	s	15.00	●
F15.09	Fundamental frequency of acceleration and deceleration time	0: maximum frequency F00.16 1: 50.00Hz 2: set frequency		0	○

The system has four groups (F00.14 and F00.15 in the first group) of acceleration and deceleration time options to meet different needs for normal operation. After completing the setting, the user can switch them via the combination of digital input functions “19: acceleration and deceleration time terminal 1” and “20: acceleration and deceleration time terminal 2”. For details, please see: Table 7-6 Function List of Multi-function Digital Input Terminals.

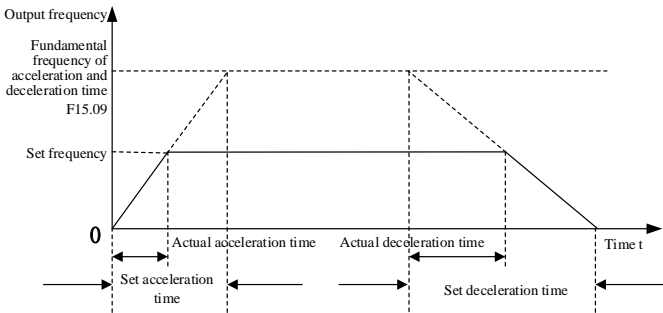

Fig. 7-33 Schematic Diagram of Acceleration and Deceleration Time

As shown in Fig. 7-33, the acceleration time is defined as the time of acceleration from 0.00 Hz to the reference frequency of acceleration/deceleration time; and the deceleration time is defined as the time of deceleration from the reference frequency of acceleration/deceleration time to 0.00 Hz. The actual acceleration/deceleration time varies according to the ratio between the set frequency and reference frequency.

The reference frequency of acceleration/deceleration time is set by function code F15.09 that represents the reference frequency of acceleration/deceleration time. If F15.09=0, the reference frequency depends on the function code F00.16 (maximum frequency). Assuming F00.16=100.00Hz, the acceleration (deceleration) time is expressed as the time for the output frequency to increase (decrease) from 0.00Hz (100.00Hz) to 100.00Hz (0.00Hz). If F15.09=2, the reference frequency depends on the function code F18.01 (set frequency). Assuming F18.01=100.00Hz, the acceleration (deceleration) time is expressed as the time for the output frequency to increase (decrease) from 0.00Hz (100.00Hz) to 100.00Hz (0.00Hz).

Function code	Function code name	Parameter description	Unit	Default setting	Attribute
F15.10	Automatic switching of acceleration and deceleration time	0: Invalid 1: valid		0	○
F15.11	Switching frequency of acceleration time 1 and 2	0.00 to maximum frequency F00.16	Hz	0.00	●
F15.12	Switching frequency of deceleration time 1 and 2	0.00 to maximum frequency F00.16	Hz	0.00	●

If the motor 1 is running at the normal (e.g. non-PLC/PID) speed (e.g. non-torque) and the acceleration/deceleration time terminals (19: acceleration and deceleration time terminal 1; 20: acceleration and deceleration time terminal 2) are invalid, the acceleration/deceleration time 1 and acceleration/deceleration time 2 can be switched by setting F15.10 to 1, as detailed in Fig. 7-34.

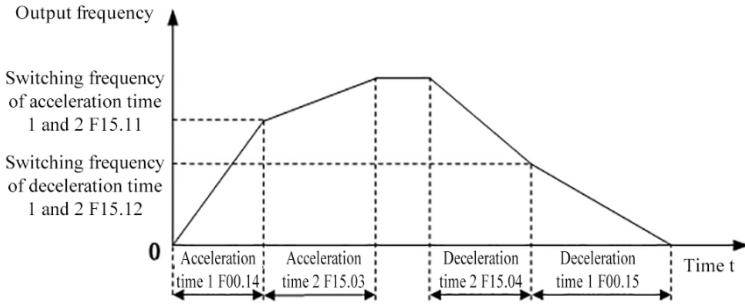

Fig. 7-34 Schematic Diagram of Automatic Switching of Acceleration and Deceleration Time

During acceleration, if the output frequency is less than the switching frequency of the acceleration time 1 and 2 (F15.11), the acceleration time 1 will be the current valid acceleration time; otherwise, the acceleration time 2 will be the current valid acceleration time.

During deceleration, if the output frequency is less than the switching frequency of the deceleration time 1 and 2 (F15.12), the deceleration time 1 will be the current valid deceleration time; otherwise, the deceleration time 2 will be the current valid deceleration time.

Function code	Function code name	Parameter description	Unit	Default setting	Attribute
F15.13	Acceleration and deceleration time unit	0:0.01s 1:0.1s 2:1s		0	○

Under different working conditions, the acceleration and deceleration time requirements may vary greatly. The system provides three acceleration and deceleration time units, depending on the function code F15.13. F15.13=1 means that the acceleration/deceleration time unit is “0.1s”. Except for that in torque control (F13.06), all the acceleration and deceleration time will change. For example, the value of F00.14 will change from 15.00s to 150.0s by default.

Function code	Function code name	Parameter description	Unit	Default setting	Attribute
F15.14	Frequency hopping point 1	0.00-600.00	Hz	600.00	●
F15.15	Hopping range 1	0.00-20.00, 0.00 is invalid	Hz	0.00	●
F15.16	Frequency hopping point 2	0.00-600.00	Hz	600.00	●
F15.17	Hopping range 2	0.00-20.00, 0.00 is invalid	Hz	0.00	●

F15.18	Frequency hopping point 3	0.00-600.00	Hz	600.00	●
F15.19	Hopping range 3	0.00-20.00, 0.00 is invalid	Hz	0.00	●

The frequency hopping function (FH function for short) can prevent the output frequency of the inverter from the mechanical resonance frequency point of the mechanical load. If the inverter is prohibited from running at a constant speed within the frequency hopping range, hopping will not occur during acceleration. Instead, the inverter will run smoothly.

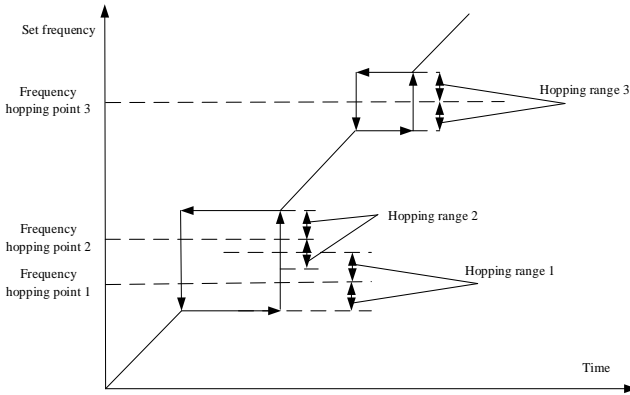

Fig. 7-35 Schematic Diagram of Frequency Hopping

As shown in Fig. 7-35, the frequency hopping function is set in the form of “frequency hopping point + hopping range”. The specific frequency hopping range is (frequency hopping point - hopping range, frequency hopping point + hopping range). At most three frequency hopping areas can be set. When the respective hopping range is 0, the corresponding frequency hopping function will be invalid.

When the frequency hopping function is valid and the set frequency rises within the regulation range, the final set frequency is “frequency hopping point - hopping range”; and when the frequency hopping function drops, the final set frequency is “frequency hopping point + hopping range”.

Multiple frequency hopping areas can be superimposed, as shown in the frequency hopping areas 1 and 2 in Fig. 7-35. The final frequency hopping range is (frequency hopping point 1 - hopping range 1, frequency hopping point 2 + hopping range 2).

Function code	Function code name	Parameter description	Unit	Default setting	Attribute
F15.20	Detection width of output frequency arrival (FAR)	0.00 - 50.00	Hz	2.50	○

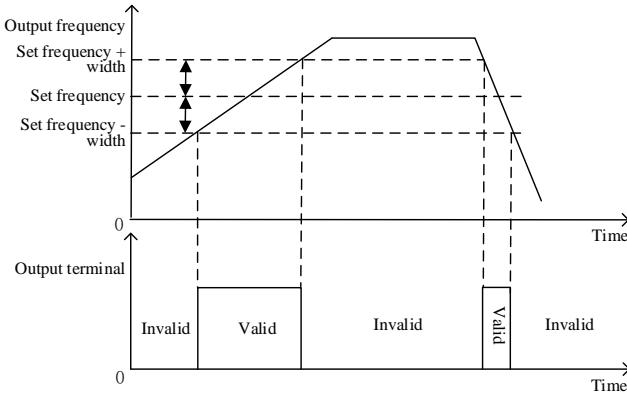

Fig. 7-36 Schematic Diagram of FAR Detection

As shown in Fig. 7-36, when the multi-function output terminal or relay output is set to “2: up to output frequency (FAR)”, and the absolute value of the difference between the |output frequency| and |given frequency| is less than or equal to the set value of FAR detection width (F15.20) during inverter operation, the corresponding function terminal will output the active level. Otherwise, this terminal will output the inactive level.

Function code	Function code name	Parameter description	Unit	Default setting	Attribute
F15.21	Output frequency detection FDT1	0.00 to maximum frequency F00.16	Hz	30.00	○
F15.22	FDT1 hysteresis	-(Fmax-F15.21)~F15.21	Hz	2.00	○
F15.23	Output frequency detection FDT2	0.00 to maximum frequency F00.16	Hz	20.00	○
F15.24	FDT2 hysteresis	-(Fmax-F15.23)~F15.23	Hz	2.00	○

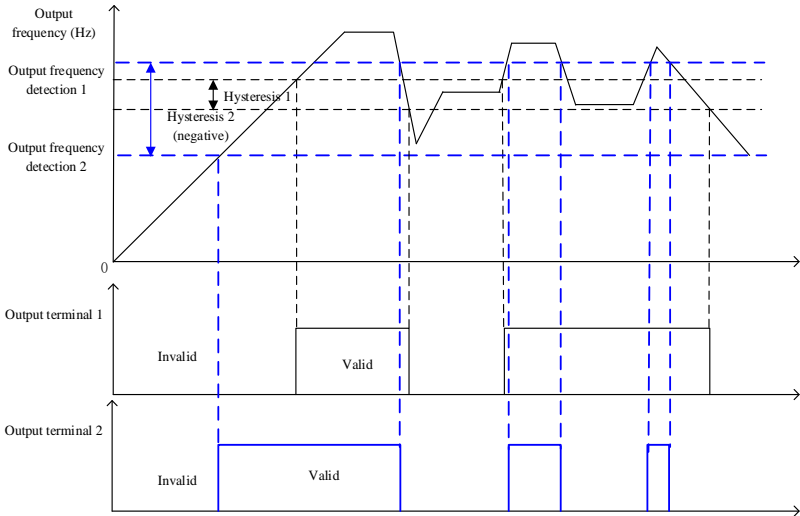

Fig. 7-37 Schematic Diagram of FDT Detection

As shown in Fig. 7-37, when the multi-function output terminal or relay output is set to “3: output frequency detection FDT1” or “4: output frequency detection FDT2” and the inverter is running:

1. If the hysteresis is positive and the |output frequency| is greater than the result of “output frequency detection FDT1/2” (F15.21/F15.23), the corresponding function terminal will output the active level; if the |output frequency| drops to less than the result of “output frequency detection FDT1/2 (F15.21/F15.23) - FDT1/2 hysteresis (F15.22/F15.24)”, the corresponding function terminal will output the inactive level; and if the |output frequency| is within the range of (output frequency detection - hysteresis, output frequency detection), the output level of the corresponding function terminal will remain unchanged.

2. If the hysteresis is negative and the |output frequency| is greater than the result of “output frequency detection FDT1/2” (F15.21/F15.23), the corresponding function terminal will output the active level; if the |output frequency| drops to less than the result of “output frequency detection FDT1/2 (F15.21/F15.23) - FDT1/2 hysteresis (F15.22/F15.24)”, the corresponding function terminal will output the inactive level; and if the |output frequency| is within the range

of (output frequency detection, output frequency detection - hysteresis.), the output level of the corresponding function terminal will remain unchanged.

Function code	Function code name	Parameter description	Unit	Default setting	Attribute
F15.25	Options of analog level detection ADT	0:AI1 1: AI2		0	○
F15.26	Analog level detection ADT1	0.00-100.00	%	20.00	●
F15.27	ADT1 hysteresis	0.00 to F15.26 (valid down in one direction)	%	5.00	●
F15.28	Analog level detection ADT2	0.00-100.00	%	50.00	●
F15.29	ADT2 hysteresis	0.00 to F15.28 (valid down in one direction)	%	5.00	●

The analog level detection function is used to detect and monitor the analog input of the current selected F15.25 channel, and also perform internal operation and external alarm monitoring. Two detection conditions can be set, but only one analog input channel can be detected.

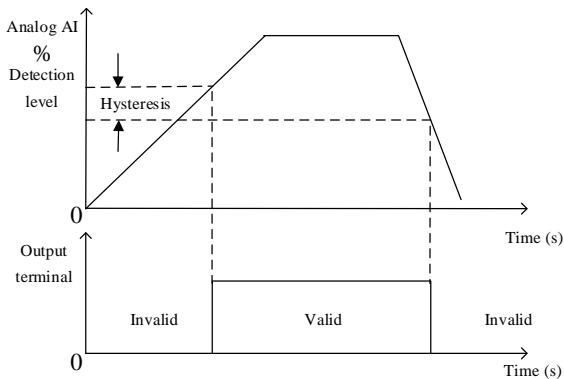

Fig. 7-38 Schematic Diagram of ADT Detection

As shown in Fig. 7-38, a valid starting point has been set for the detection level. When the percentage of analog input is above the detection level after offset processing, the ADT function will be valid. The conditions for invalid ADT function are dependent on the one-way downward hysteresis. When the conversion result of analog input decreases to less than the result of

“detection level - hysteresis”, the ADT function will be invalid.

Function code	Function code name	Parameter description	Unit	Default setting	Attribute
F15.30	Options of energy consumption braking function	0: Invalid 1: valid		0	○
F15.31	Energy consumption braking voltage	110.0-140.0 (380V, 100.0 = 537V)	%	125.0(671V)	○
F15.32	Braking rate	20-100 (100 means that duty ratio is 1)	%	100	●

Energy consumption braking is a braking method for quick deceleration by converting the energy generated in deceleration into the thermal energy of the braking resistor. It is suitable for braking under large-inertia loads or stop by rapid braking. In this case, it is necessary to select the appropriate braking resistor and braking unit, as detailed in 10.1Braking Resistor and 10.2Braking unit.

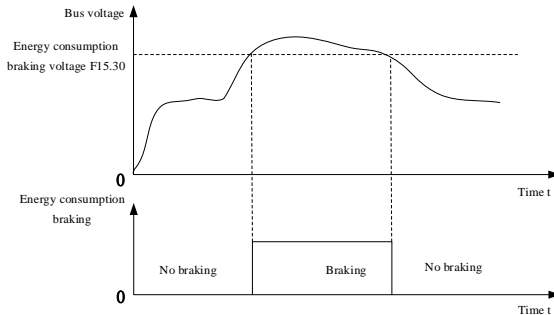

Fig. 7-39 Schematic Diagram of Energy Consumption Braking

In the case of valid energy consumption braking (F15.30=1), as shown in Fig. 7-39, when the bus voltage is greater than the energy consumption braking voltage (F15.31), energy consumption braking will be started; and when the bus voltage decreases to less than the aforesaid value, energy consumption braking will be disabled.

The IGBT in the braking unit is engaged during energy consumption braking. Energy can be quickly released by the braking resistor. The braking utilization rate (F15.32) is the duty cycle of IGBT running. The greater the duty cycle, the larger the degree of braking is.

Function code	Function code name	Parameter description	Unit	Default setting	Attribute
F15.33	Operating mode with set frequency less than lower frequency limit	0: running at the lower frequency limit 1: Shutdown		0	○

When the set frequency of the inverter is lower than the lower frequency limit (F00.19), the running status depends on the function code F15.33.

Function code	Function code name	Parameter description	Unit	Default setting	Attribute
F15.34	Fan control	0: running after power-on 1: running at startup 2: intelligent operation, subject to temperature control		1	○

In order to use the fan reasonably, the fan system has three running modes, depending on the fan control function code (F15.34). The specific running mode of the fan is shown in Table 7-23.

Table 7-23 Details of Fan Operation

Fan control	Fan operation
0: running after power-on	When the inverter is powered on, the fan will start running.
1: running at startup	When the inverter starts running, the fan will start running. When this parameter is set to 1 min, the fan will stop running.
2: intelligent operation, subject to temperature control	When the temperature of the inverter is greater than 45 °C, the fan will start running; when the temperature of the inverter is less than 40 °C, the fan will stop running; and when the temperature of the inverter is in between the two values, the fan will remain unchanged.

- ★ When “2: intelligent operation, subject to temperature control” is selected, make sure that the temperature detection module of the inverter works properly.

Function code	Function code name	Parameter description	Unit	Default setting	Attribute
F15.35	Overmodulation intensity	1.00 - 1.10		1.05	●

When the input voltage of the inverter is lower than the output voltage, you can increase the overmodulation intensity to improve the bus voltage utilization and thus increase the upper limit of output voltage. When F15.35=1.10, the upper limit of output voltage can be increased by 10%, thus reducing the output current under heavy loads, but the current harmonics will

increase.

Function code	Function code name	Parameter description	Unit	Default setting	Attribute
F15.36	Switching options of PWM modulation mode	0: invalid (7-segment PWM modulation) 1: valid (5-segment PWM modulation)		0	○
F15.37	Switching frequency of PWM modulation mode	0.00 to maximum frequency F00.16	Hz	15.00	●

When the PWM modulation mode is invalid (F15.36=0), the 7-segment PWM modulation will be enabled. When the WM modulation mode is valid (F15.36=1), the 7-segment PWM modulation will be enabled at the output frequency lower than the switching frequency (F15.37) and the 5-segment PWM modulation will be enabled at the output frequency higher than the switching frequency. The 7-segment PWM modulation has a smaller current ripple than 5-segment PWM modulation, but involves larger switching loss, more heat from the inverter, and larger temperature rise.

Function code	Function code name	Parameter description	Unit	Default setting	Attribute
F15.38	Options of dead zone compensation mode	0: no compensation 1: compensation mode 1 2: compensation mode 2		1	○

This parameter does not need to change under normal circumstances in the dead zone compensation mode. Users need to select a different compensation mode only in case of special requirements for the quality of the output voltage waveform or other abnormalities (e.g. motor oscillation).

The compensation mode 1 is often selected. If the motor is prone to oscillation at high power and under VF control, the compensation mode 2 may be selected.

Function code	Function code name	Parameter description	Unit	Default setting	Attribute
F15.39	Terminal jog priority	0: Invalid 1: valid		0	○

In the terminal control mode (F00.02=1), this function code is used to set the highest priority of the jog command. If the terminal jog priority is valid (F15.39=1), the running status can be switched to jog running in the presence of a valid jog terminal; and if the terminal jog priority is invalid (F15.39=0), the running status cannot be directly switched to jog running.

Function code	Function code name	Parameter description	Unit	Default setting	Attribute
F15.40	Deceleration time for quick stop	0.00 - 650.00 (F15.13=0) 0.0 - 6500.0 (F15.13=1) 0 - 65000 (F15.13=2)	s	1.00	●

Set the acceleration and deceleration time during rapid stop.

Function code	Function code name	Parameter description	Unit	Default setting	Attribute
F15.66	Overcurrent detection level	0.1-300.0 (0.0: no detection; 100.0%: corresponding to the rated current of motor)	%	200.0	●
F15.67	Overcurrent detection delay time	0.00-600.00	s	0.00	●

When the current exceeds the overcurrent detection level (F15.66) and the duration reaches F15.67, the function “73: output overcurrent” of the output terminal will be valid.

Function code	Function code name	Parameter description	Unit	Default setting	Attribute
F15.68	Market price	0.00-100.00		1.00	○

Set the current electricity price in the market and calculate the electricity savings. The electricity savings can be viewed by the function codes F18.69 and F18.70.

Function code	Function code name	Parameter description	Unit	Default setting	Attribute
F15.69	Power-frequency load factor	30.0-200.0	%	90.0	○

Set the coefficient of the power frequency load.

7.17 F16 customized function parameter group

Function code	Function code name	Parameter description	Unit	Default setting	Attribute
F16.00	Industry application	0: Universal model 1: Water supply application 2: Air compressor application 3: Winding application 4: fan application 5: Spindle application of machine tool		0	○

		6: Extruder application 7: High-speed motor application			
--	--	--	--	--	--

F16.00=0: general model

Since the inverter is a general-purpose product, relevant functions for each application should not be enabled.

F16.00=1: water supply application

Since the inverter is a PID-regulated constant-pressure water supply control product, a clock option can be provided for clock pressure setting.

F16.00=2: Air compressor application

Since the inverter is a dedicated PID-regulated control product for air compressors, an air compressor interface option can be provided for PT100 automatic temperature calculation and the like.

F16.00=3: Winding application

The inverter is a dedicated PID-regulated control product for winding and unwinding.

F16.00=4: Fan application

The inverter can be used to configure the parameters of the corresponding function code for the fan application macro.

F16.00=5: Machine tool spindle application

The inverter can be used to configure the parameters of the corresponding function code for the application micro of machine tool spindle.

F16.00=6: Extruder application

The inverter can be used to configure the parameters of the corresponding function code for the extruder application macro.

F16.00=7: High-speed motor application

The inverter can be used to configure the parameters of the corresponding function code for the high-speed motor application macro.



After the corresponding application macro is selected by changing the function code, F12.14 will be executed automatically to restore the default settings, and the parameters will be restored the macro-specific parameters.

Function code	Function code name	Parameter description	Unit	Default setting	Attribute
F16.01	Set length	1 - 65535 (F16.13=0) 0.1 - 6553.5 (F16.13=1) 0.01 - 655.35 (F16.13=2) 0.001 - 65.535 (F16.13=3)	m	1,000	●
F16.02	Pulses per meter	0.1 - 6553.5		100.0	●
F16.13	Set length resolution	0:1m 1:0.1m 2:0.01 m 3:0.001m		0	○

EM730/EM730E series inverters have a fixed-length counting function, as shown in Fig. 7-40. The length counting function is performed by entering the length information from the digital input terminal in the pulse form and then setting the related function code. The final length count information can be outputted by the digital output terminal for other purposes (e.g. DI/VX input as the stop command). Users can also view the real-time length count via F18.34. The length resolution can be set by F16.13. In case of any change in the length resolution, F16.01 will change accordingly. For example, if F16.13 is set to 0:1m, the setting range of F16.01 is 1-65535m.

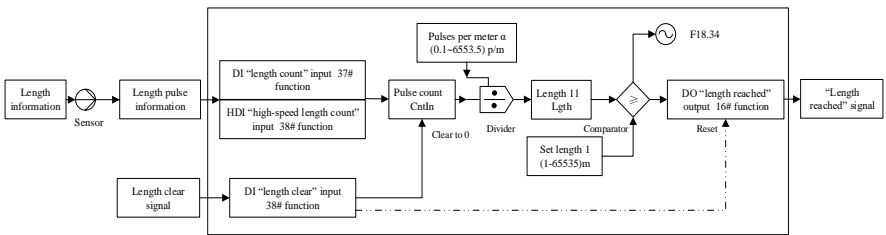

Fig. 7-40 Block Diagram of Fixed-length Counting

Principle of fixed-length counting: The length detection sensor converts the length information into pulse information. The DI terminal collects the number N of input pulses.

The length $l_1 = \frac{N}{\alpha}$ is calculated based on the set function code "Pulses per meter" α and

then compared with the “Set length” l . If $l_1 < l$, it means that the length does not reach the set value; otherwise, the fixed-length count is completed. The “39: Clear length” input can be applied to clear the count and reset the output signal.

When the pulse frequency is greater than 250Hz ($=1/(2 \text{ (default filtering times)} * 2 * 1\text{ms}^{-1})$), make sure of the input from the high-speed pulse input terminal (X5) and set F02.06 to “38: high-speed length count input”. 250Hz is only a theoretical value. The actual effect will prevail. In order to avoid errors, use the high-speed pulse input terminal wherever possible.

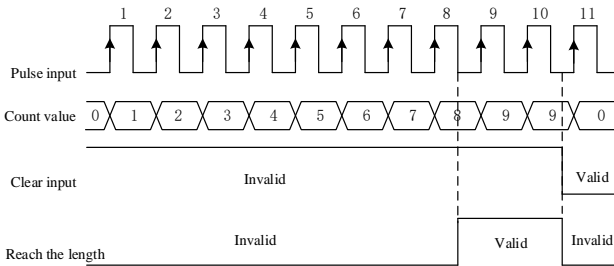

Fig. 7-15 Example of Fixed-length Counting

Fig. 7-15 shows an example, where F16.01=2 and F16.02=4.0. When the length count is 8 ($=2 \times 4$), the “16: length reached” output will be valid. When the “39: clear length” input is valid, the count will be cleared, and the “16: length reached” output will be invalid.

Function code	Function code name	Parameter description	Unit	Default setting	Attribute
F16.03	Set count value	F16.04 - 65535		1,000	●
F16.04	Specified count value	1 - F16.03		1,000	●

EM730/EM730E series inverters support counting, as shown in Fig. 7-42. Pulse information is inputted from the digital input terminal. When the count reaches the specific value, there will be the corresponding valid signal output. The user can use this signal for programming (e.g. DI/VX input as the stop command) or view the real-time count by F18.33.

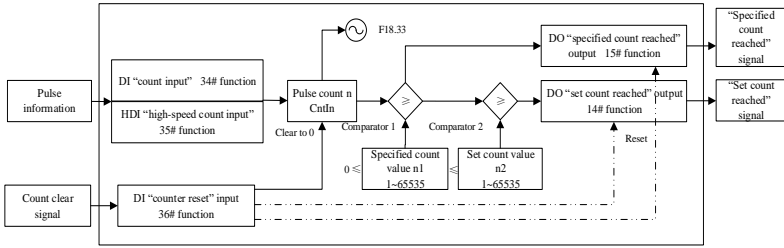

Fig. 7-42 Block Diagram of Counting Function

Counting principle: Specific information is entered in the pulse form. The number n of pulses is collected by the DI terminal and then is compared with the “specified count” n_1 . If $n < n_1$, it means that the value does not reach the “specified count”. Otherwise, it means that the value reaches the “specified count”, the result is outputted by the DO terminal, counting is continued, and the value is compared with the “set count” n_2 . If $n < n_2$, it means that the value does not reach the “set count”. Otherwise, it means that the value reaches the “set count”, the result will be outputted by the DO terminal and counting will be stopped. The “36: clear counter” input can be used to clear the count and reset the output signal.

When the pulse frequency exceeds 250Hz ($=1/(2 \text{ (default filtering times)} * 2 * 1 \text{ms}^{-1})$), make sure of the input through the high-speed pulse input terminal (X5), and set F02.06 to “35: high-speed count input”. 250Hz is only a theoretical value. The actual effect will prevail. In order to avoid errors, use the high-speed pulse input terminal wherever possible.

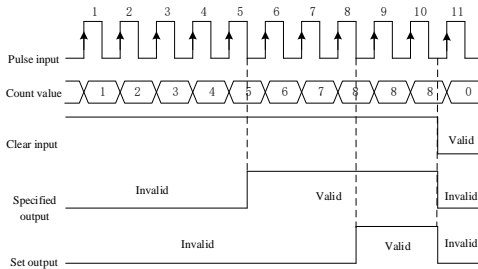

Fig. 7-16 Counting Example Fig. 7-16 shows an example, where F16.03=8 and F16.04=5. When the count reaches the specified value 5, the output of “15: reach the specified value” will

be valid. When the count reaches the set value 8, the output of “14: reach the set value” will be valid. When the input of “36: clear length” is valid, the count will be cleared to 0, and the outputs of “15: reach the specified value” and “14: reach the set value” will be invalid.



Limit65535 ≥ set count ≥ specified count ≥ 0. If the set count and specified count are 0, the counter function will be invalid. This function is allowed for one terminal only at a time.

Function code	Function code name	Parameter description	Unit	Default setting	Attribute
F16.05	Set time of regular running	0.0-6500.0, 0.0 is invalid	min	0.0	●

Regular running function: The regular running function can be enabled by setting this function code other than 0. When the running time reaches the set time, the inverter will be shut down, and the terminal output of the option “26: reach the set time” will be valid, and there will be a prompt indicating that the inverter has been run for the set time.

Users can view the remaining time of regular running by F18.35, or clear the current running time by the input function “27: clear regular running time” (i.e. resetting F18.35). This represents the set time in the non-running status and remaining time in the running status. That is, one regular running process lasts from start to stop, and the accumulated time in the non-running status will be cleared.

Function code	Function code name	Parameter description	Unit	Default setting	Attribute
F16.06	Agent password	0 - 65535		0	○

Agent password.

- ★ After this password is set, the inverter may fail to work normally. Be careful to set this password.

Function code	Function code name	Parameter description	Unit	Default setting	Attribute
F16.07	Setting of cumulative power-on arrival time	0-65535; 0: disable the protection when the power-on time is up	h	0	○

Set the total cumulative power-on time. If the cumulative power-on time (F12.15) reaches or exceeds the total cumulative power-on time (F16.07), please contact the agent for maintenance.

- ★ After this parameter is set, the inverter may fail to work normally. Be careful to set this parameter.

Function code	Function code name	Parameter description	Unit	Default setting	Attribute
F16.08	Setting of cumulative running arrival time	0-65535; 0: disable the protection when the running time is up	h	0	○

Set the total cumulative running time. If the cumulative running time (F12.17) reaches or exceeds the total cumulative running time (F16.08), please contact the agent for maintenance.

- ★ After this parameter is set, the inverter may fail to work normally. Be careful to set this parameter.

Function code	Function code name	Parameter description	Unit	Default setting	Attribute
F16.09	Factory password	0 - 65535		XXXXXX	●

Factory password.

- ★ After this password is set, the inverter may fail to work normally. Be careful to set this password.

Function code	Function code name	Parameter description	Unit	Default setting	Attribute
F16.10	Analog output percentage corresponding to the count value 0	0.00-100.00	%	0.00	○
F16.11	Analog output percentage corresponding to the set count value	0.00-100.00	%	100.00	○

The analog output is set as the offset of count and length output.

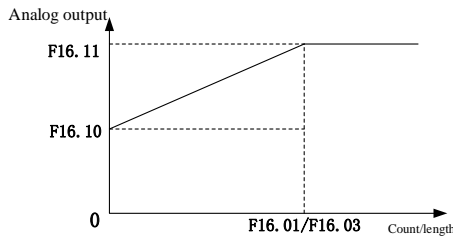

Fig. 7-17 Schematic Diagram of Analog Output of Count and Length

7.18 Virtual I/O Function Parameter Group of F17 Group

The standard EM730/EM730E series inverter is equipped with eight virtual multi-function

input terminals (VX1 to VX8), of which the functions and usages are basically the same as those of the actual input terminals. Differences are described below. For their similarities, refer to the parameter description of Function Parameter Group of Input Terminal of F02 Group.

Function code	Function code name	Parameter description	Unit	Default setting	Attribute																								
F17.00	VX1 virtual input function options	The same as the digital input terminal function options of the F02 group. See the function list of the digital multi-function input terminal in Table 7-2.		0	○																								
F17.01	VX2 virtual input function options			0	○																								
F17.02	VX3 virtual input function options			0	○																								
F17.03	VX4 virtual input function options			0	○																								
F17.04	VX5 virtual input function options			0	○																								
F17.05	VX6 virtual input function options			0	○																								
F17.06	VX7 virtual input function options			0	○																								
F17.07	VX8 virtual input function options			0	○																								
F17.08	Virtual input positive/negative logic	<table border="1" style="width: 100%; border-collapse: collapse;"> <tr> <td>D7</td><td>D6</td><td>D5</td><td>D4</td><td>D3</td><td>D2</td><td>D1</td><td>D0</td> </tr> <tr> <td>VX</td><td>VX</td><td>VX</td><td>VX</td><td>VX</td><td>VX</td><td>VX</td><td>VX</td> </tr> <tr> <td>7</td><td>6</td><td>6</td><td>5</td><td>4</td><td>3</td><td>2</td><td>1</td> </tr> </table> <p>0: positive logic, valid in the closed state/invalid in the open state 1: Negative logic, invalid in the closed state/valid in the open state</p>	D7	D6	D5	D4	D3	D2	D1	D0	VX	VX	VX	VX	VX	VX	VX	VX	7	6	6	5	4	3	2	1		000 00000	○
D7	D6	D5	D4	D3	D2	D1	D0																						
VX	VX	VX	VX	VX	VX	VX	VX																						
7	6	6	5	4	3	2	1																						
F17.11	VX1 valid delay time	0.000-30.000	s	0.000	●																								
F17.12	VX1 invalid delay time	0.000-30.000	s	0.000	●																								
F17.13	VX2 valid delay time	0.000-30.000	s	0.000	●																								
F17.14	VX2 invalid delay time	0.000-30.000	s	0.000	●																								
F17.15	VX3 valid delay time	0.000-30.000	s	0.000	●																								
F17.16	VX3 invalid delay time	0.000-30.000	s	0.000	●																								
F17.17	VX4 valid delay time	0.000-30.000	s	0.000	●																								
F17.18	VX4 invalid delay time	0.000-30.000	s	0.000	●																								

The terminals VX1 to VX8 essentially have the same function, but there are no corresponding physical terminals actually. They all have the positive and negative logic functions. The terminals VX1 to VX4 have the delay function, and their statuses can be confirmed in the same way. They can be set separately. The terminal VX1 is taken as an example below.

Function code	Function code name	Parameter description								Unit	Default setting	Attribute
F17.09	VX1-VX8 status setting options	D7	D6	D5	D4	D3	D2	D1	D0		000 00000	○
		VX8	VX7	VX6	VX5	VX4	VX3	VX2	VX1			
		0: the VXn status is the same as VYn output status 1: status set by F17.10										
F17.10	VX1-VX8 status setting	D7	D6	D5	D4	D3	D2	D1	D0		000 00000	●
		VX8	VX7	VX6	VX5	VX4	VX3	VX2	VX1			
		0: Invalid 1: valid										

- When F17.09=xxxxxxx0, the VX1 status is the same as the VY1 output status.

As stated literally, the status of the virtual input terminal is the same as that of the virtual output terminal, so this should be used in conjunction with the virtual output terminal.

If F17.19=16 (reach the length) and F17.28=xxxx xxx1 (the VY1 status depends on the output function status) under the default conditions, and “16: reach the length” is valid, the VY1 output and VX1 synchronization will be valid. The corresponding operations (length count clearing and VY1 output status resetting) can be performed according to the VX1 setting (assuming “39: length clearing”). Then the fixed length count function can be enabled again to meet the requirements for repeated processing. If there are certain intervals between repeated processing procedures, you can also complete the aforesaid operations by setting the VX1 delay.

- When F17.09=xxxxxxx1, the VX1 status depends on the bit 0 of the function code F17.10.

The status of the virtual input terminal is directly dependent on the function code. This is mainly used for remote control by the host. The remote control terminal can be used to enable and disable the input terminal status directly with the function code 0x41 by changing the value of F17.10 through communication.

The standard EM730/EM730E series inverter is equipped with eight virtual multi-function output terminals (VY1 to VY8), and their functions and usages are essentially the same as those of the actual output terminals. Differences are described below. For their similarities, refer to the parameter description of Function Parameter Group of Output Terminal of F03 Group.

Function code	Function code name	Parameter description									Unit	Default setting	Attribute
F17.19	VY1 virtual output function options	The same as the digital output terminal function options of the F03 group, as detailed in Table 7-8 Function List of Multi-function Digital Output Terminals										0	○
F17.20	VY2 virtual output function options											0	○
F17.21	VY3 virtual output function options											0	○
F17.22	VY4 virtual output function options											0	○
F17.23	VY5 virtual output function options											0	○
F17.24	VY6 virtual output function options											0	○
F17.25	VY7 virtual output function options											0	○
F17.26	VY8 virtual output function options											0	○
F17.27	Virtual output positive/negative logic	D7	D6	D5	D4	D3	D2	D1	D0		000 00000	○	
		VY8	VY7	VY6	VY5	VY4	VY3	VY2	VY1	0: positive logic, valid in the closed state/invalid in the open state 1: Negative logic, invalid in the closed state/valid in the open state			
F17.29	VY1 valid delay time	0.000-30.000									s	0.000	●
F17.30	VY1 invalid delay time	0.000-30.000									s	0.000	●
F17.31	VY2 valid delay time	0.000-30.000									s	0.000	●
F17.32	VY2 invalid delay time	0.000-30.000									s	0.000	●
F17.33	VY3 valid delay time	0.000-30.000									s	0.000	●
F17.34	VY3 invalid delay time	0.000-30.000									s	0.000	●

F17.35	VY4 valid delay time	0.000-30.000	s	0.000	●
F17.36	VY4 invalid delay time	0.000-30.000	s	0.000	●

The terminals VY1 to VY8 essentially have the same function, but there are no corresponding physical terminals actually. They all have the positive and negative logic functions. The terminals VY1 to VY4 have the delay function, and their statuses can be confirmed in the same way. They can be set separately. The terminal VY1 is taken as an example below.

Function code	Function code name	Parameter description								Unit	Default setting	Attribute
F17.28	Control options of virtual output terminal	D7	D6	D5	D4	D3	D2	D1	D0		111 11111	○
		VY8	VY7	VY6	VY5	VY4	VY3	VY2	VY1			
		0: Depending on the status of terminal X1-X5 (without VY6-8) 1: depending on the output function status										

- F17.28=xxxxxxx0: the VY1 status is the same as the actual input status of X1.

The status of the virtual output terminal VY1 is synchronized with that of the actual input terminal X1. This can be applied in programming of multiple functions such as status confirmation or enabling of one switch.

- F17.28=xxxxxxx1: the VY1 status depends on the selected function status of the function code F17.19.

The status of the virtual output terminal depends on the set function status, and its main output is for software programming. The PID can be controlled via “reaching the upper limit of PID feedback” as follows: outputting the signal “19: reach the upper limit of PID feedback” through the virtual output terminal VY1 (F17.19=19), collecting it through the virtual input terminal VX1 and then setting the VX1 function to “41: process PID pause” (F17.00=41).

Note: The D7 bit of the VY8 option must be set to 1. That is, the VY8 function is always dependent on the output function status.

Function code	Function code name	Parameter description								Unit	Default setting	Attribute
F17.37	Virtual input terminal status	VX8	VX7	VX6	VX5	VX4	VX3	VX2	VX1		000 00000	×
		0: Invalid										

		1: valid									
F17.38	Virtual output terminal status	VY8	VY7	VY6	VY5	VY4	VY3	VY2	VY1	000 00000	×
		0: Invalid									
		1: valid									

The real-time status of the current virtual terminal is displayed.

7.19 Monitoring Parameter Group of F18 Group

This group of parameters is used only to view the current status of the inverter and cannot be changed.

Function code	Function code name	Parameter description	Unit
F18.00	Output frequency	Display the current output frequency of the inverter. Scope: 0.00 to upper frequency limit. ★: This parameter will be updated promptly in the speed control mode.	Hz
F18.01	Set frequency	Display the current set frequency of the inverter. Scope: 0.00 to maximum frequency F00.16. ★: This parameter will be updated promptly in the speed control mode.	Hz
F18.02	Reserved		
F18.03	Estimate feedback frequency	Display the estimated feedback frequency in the SVC control mode. Scope: 0.00 to upper frequency limit. ★: This parameter will be updated promptly in the SVC control mode.	Hz
F18.04	Output torque	Display the current output torque of the inverter. Scope: -200.0 - 200.0.	%
F18.05	Torque setting	Display the current set torque of the inverter. Scope: -200.0 - 200.0. ★: This parameter will be updated promptly in the torque control mode.	%
F18.06	Output current	Display the current output current of the inverter. Depending on the rated power level of the motor, the range is as follows: 0.00 to 650.00 (rated power of motor: ≤ 75 kW) 0.0 to 6500.0 (rated power of motor: > 75 kW)	A
F18.07	Output current percentage	Display the current output current as a percentage (relative to the rated current of the inverter). Range: 0.0 to 300.0.	%
F18.08	Output voltage	Display the current output voltage of the inverter. Scope: 0.0 - 690.0.	V
F18.09	DC bus voltage	Display the current bus voltage. Scope: 0 - 1200.	V

F18.10	Simple PLC running times	When the auxiliary frequency source B is involved in setting (F00.06 ≠ 0), the setting mode is “11: simple PLC” (F00.05=11) and the simple PLC runs in the mode of limited cycles (F08.15=1/2), the real-time number of cycles will be displayed. “0” indicates that the first operation is being performed, and “1” indicates that the first operation has been completed and the second operation is being carried out. Scope: 0 - F08.16.	
F18.11	Simple PLC operation stage	When the auxiliary frequency source B is involved in setting (F00.06 ≠ 0), and the setting mode is “11: simple PLC” (F00.05=11), the real-time PLC running status will be displayed. Scope: 1-15, corresponding to the multi-segment speed 1 (F08.00) to multi-segment speed 15 (F08.14).	
F18.12	PLC running time at the current stage	When the auxiliary frequency source B is involved in setting (F00.06 ≠ 0) and the setting mode is “11: simple PLC” (F00.05=11), the PLC running time at the current stage will be displayed in a real-time manner. Scope: 0.0 to the set time of the corresponding segment (example: the time of the first segment is dependent on F08.20).	s / min
F18.13	Reserved		
F18.14	Load rate	Display the current load speed. For the correct display, please set the load speed display factor (F12.09). Scope: 0 - 65535.	rpm
F18.15	UP/DOWN offset frequency	Display the UP/DOWN offset frequency. See the UP/DOWN function description of F12.10 to F12.12.	Hz
F18.16	PID setting	Display the current PID setting, except for the current setting percentage (F09.03).	
F18.17	PID feedback	Display the current PID feedback, except for the current feedback percentage (F09.03).	
F18.18	Power meter: MWh	Display the cumulative input (output + fan) power consumption in MWh (thousand kWh). The current power consumption can be obtained in conjunction with F18.19.	MWh
F18.19	Watt-hour meter: kWh	Display the cumulative input (output + fan) power consumption in kWh (kilowatt-hour). The current power consumption can be obtained in conjunction with F18.18.	kWh
F18.20	Output power	Display the current output power of the inverter. Scope: -650.00~650.00.	kW
F18.21	Output power factor	Display the current output power factor of the inverter. Scope: -1.00 - 1.00.	
F18.22	Digital input terminal status 1	Display the current valid status of the input terminals X1 to X5. The five-bit digit tubes from left to right are:	

		<table border="1"> <tr> <td>X5</td> <td>X4</td> <td>X3</td> <td>X2</td> <td>X1</td> </tr> <tr> <td>0/1</td> <td>0/1</td> <td>0/1</td> <td>0/1</td> <td>0/1</td> </tr> </table> <p>The actual display effect is: 00000. ★: “0” means that the current terminal function is invalid; and “1” means that the current terminal function is valid.</p>	X5	X4	X3	X2	X1	0/1	0/1	0/1	0/1	0/1	
X5	X4	X3	X2	X1									
0/1	0/1	0/1	0/1	0/1									
F18.23	Digital input terminal status 2	<p>Display the current valid status of the input terminals AI1 and AI2. The five-bit digit tubes from left to right are:</p> <table border="1"> <tr> <td>*</td> <td>AI2</td> <td>AI1</td> <td>*</td> <td>*</td> </tr> <tr> <td>0/1</td> <td>0/1</td> <td>0/1</td> <td>0/1</td> <td>0/1</td> </tr> </table> <p>The actual display effect is: 00000. ★: The analog input terminals AI1 and AI2 of the EM730/EM730E series inverter can be used for digital input only. “0” means that the current terminal function is invalid; and “1” means that the current terminal function is valid.</p>	*	AI2	AI1	*	*	0/1	0/1	0/1	0/1	0/1	
*	AI2	AI1	*	*									
0/1	0/1	0/1	0/1	0/1									

F18.25	Output terminal state	<p>Display the current valid status of the output terminals R1/Y1. The five-bit digital tubes from left to right are:</p> <table border="1"> <tr> <td>*</td> <td>*</td> <td>R1</td> <td>*</td> <td>Y1</td> </tr> <tr> <td>0/1</td> <td>0/1</td> <td>0/1</td> <td>0/1</td> <td>0/1</td> </tr> </table> <p>The actual display effect is: 000. “0” means that the current function terminal is invalid; and “1” means that the current function terminal is valid.</p>	*	*	R1	*	Y1	0/1	0/1	0/1	0/1	0/1	
*	*	R1	*	Y1									
0/1	0/1	0/1	0/1	0/1									
F18.26	AI1	Display the per-unit value of the current analog input channel 1 (AI1) relative to 100.0%. Scope: -100.0 - 100.0	%										
F18.27	AI2	Display the per-unit value of the current analog input channel 2 (AI2) relative to 100.0%. Scope: 0.0 - 100.0.	%										
F18.30	Reserved												
F18.31	High-frequency pulse input frequency: kHz	0.00-100.00	kHz										
F18.32	High-frequency pulse input frequency: Hz	0~65535	Hz										
F18.33	Count value	0~65535											
F18.34	Actual length	0~65535	m										
F18.35	Remaining time of regular running	Display the remaining time of regular running. For specific function. see the description of the F16.05 regular running function. Scope: 0.0 - F16.05.	min										
F18.36	Rotor position of synchronous	0.0~359.9 °											

	motor		
F18.37 ~ F18.38	Reserved		
F18.39	VF separation target voltage	Display the VF separation target voltage in a real-time manner. Scope: 0.0 to rated voltage of the motor	V
F18.40	VF separation output voltage	Display the actual output voltage of VF separation in a real-time manner. Scope: 0.0 to rated voltage of the motor	V
F18.41 ~ F18.50	Reserved		
F18.51	PID output	-100.0 - 100.0	%
F18.60	Inverter temperature	-40 to 200	°C
F18.67	Cumulative energy saving MWH	0 - 65535	MWh
F18.68	Cumulative energy saving KWH	0.0 - 999.9	kWh
F18.69	High cumulative cost saving (*1000)	0 - 65535	
F18.70	Low cumulative cost saving	0.0 - 999.9	
F18.71	Power-frequency power consumption MWH	0 - 65535	MWh
F18.72	Power-frequency power consumption KWH	0.0 - 999.9	kWh

7.20 F19 protection record parameter group

These parameters are used only to view the types of recent three protections of the inverter and the inverter status in protection. They cannot be changed.

- The function codes related to the last protection are as follows:

Function code	Function code name	Parameter description	Unit	Default setting	Attribute
F19.00	Category of last protection	Display the type of the last protection, as detailed in Table		0	×

		7-24 List of Protection Types.			
F19.01	Output frequency in protection	Display the output frequency of the last protection.	Hz	0.00	×
F19.02	Output current in protection	Display the output current of the last protection.	A	0.00/0.0	×
F19.03	Bus voltage in protection	Display the bus voltage of the last protection.	V	0	×
F19.04	Operating status in protection	Display the running status of the last protection, as detailed in Table 7-25 List of Running Statuses during Protection.		0	×
F19.05	Working time in protection	Display the working time of the last protection.	h	0	×

- The function codes related to the previous protection are as follows:

Function code	Function code name	Parameter description	Unit	Default setting	Attribute
F19.06	Category of previous protection	Display the type of the previous protection, as detailed in Table 7-24 List of Protection Types.		0	×
F19.07	Output frequency in protection	Display the output frequency of the previous protection.	Hz	0.00	×
F19.08	Output current in protection	Display the output current of the previous protection.	A	0.00/0.0	×
F19.09	Bus voltage in protection	Display the bus voltage of the previous protection.	V	0	×
F19.10	Operating status in protection	Display the running status of the previous protection, as detailed in Table 7-25 List of Running Statuses during Protection.		0	×
F19.11	Working time in protection	Display the working time of the previous protection.	h	0	×

- The function codes related to the previous two protections are as follows:

Function code	Function code name	Parameter description	Unit	Default setting	Attribute
F19.12	Category of two previous protections	Display the type of the previous two protections, as detailed in Table 7-24 List of Protection Types.		0	×
F19.13	Output frequency in protection	Display the output frequency of the previous two protections.	Hz	0.00	×

F19.14	Output current in protection	Display the output current of the previous two protections.	A	0.00 /0.0	×
F19.15	Bus voltage in protection	Display the bus voltage of the previous two protections.	V	0	×
F19.16	Operating status in protection	Display the running status of the previous two protections, as detailed in Table 7-25 List of Running Statuses during Protection.		0	×
F19.17	Working time in protection	Display the working time of the previous two protections.	h	0	×

Different types of protection of EM730/EM730E series inverters are explained in Table 7-24.

Table 7-24 List of Protection Types

Protection Type	Keyboard display	Protection Type	Keyboard display
0: No protection	0	E01: output short circuit protection	E01
E02: instantaneous overcurrent	E02	E03: reserved	E03
E04: steady-state overcurrent	E04	E05: steady-state overvoltage	E05
E06: Steady-state undervoltage	E06	E07: input phase loss	E07
E08: output phase loss	E08	E09: inverter overload	E09
E10: inverter overheat protection	E10	E11: parameter setting conflict	E11
E12: retention	E12	E13: motor overload	E13
E14: External protection	E14	E15: Inverter memory protection	E15
E16: communication abnormality	E16	E17: Temperature sensor abnormality	E17
E18: disengaged soft start relay	E18	E19: current detection circuit abnormality	E19
E20: Stall protection	E20	E21: PID feedback disconnection	E21
E20: retention	E22	E23: Keyboard memory protection	E23
E24: parameter identification abnormality	E24	E25: retention	E25
E26: off-load protection	E26	E27: up to the cumulative power-on time	E27
E28: up to the cumulative running time	E28	E29: Internal communication protection	E29
E44: Cable protection	E44	E43: Material cutoff protection	E43

E57: Overpressure in pipeline network	E57	E58: Under-pressure in pipeline network	E58
E68: SVC start failure (synchronous motor)	E68	E76: Short circuit to ground	E76

The running status of EM730/EM730E series inverters during protection is explained in Table 7-25:

Table 7-25 List of Running Statuses during Protection

Keyboard display	Detailed Explanation of Running Status of Inverter
0	Not running
1	Forward acceleration
2	Reverse acceleration
3	Forward deceleration
4	Reverse deceleration
5	Forward constant speed
6	Reverse constant speed

7.21 F27 winding and unwinding application macro parameter group

Function code	Function name	Parameter description	Unit	Default setting	Attribute
F27.00	Application macro	0: Winding mode 1: Unwinding mode 2: Wire drawing mode 3: Straight wire drawing machine mode		0	○

F27.00=0 Winding mode:

This mode can be used for winding. After the default settings are restored, the parameters will be restored for winding applications.

F27.00=1 Unwinding mode:

This mode can be used for unwinding. After the default settings are restored, the parameters will be restored for unwinding applications.

F27.00=2 Wire drawing mode:

This mode can be used for wire drawing. After the default settings are restored, the parameters will be restored for wire drawing applications.

F27.00=3 Straight wire drawing machine mode:

This mode can be used for the straight wire drawing machine. After the default settings are restored, the parameters will be restored for the straight wire drawing machine.

Function	Note	0: Winding	1: Unwinding	2: Wire	3: Straight wire
----------	------	------------	--------------	---------	------------------

code		mode	mode	drawing mode	drawing machine mode
Set F16.00=3, select the operation mode and restore the default settings. The application parameters are automatically set to the following default values.					
Basic parameters (the motor parameters need to be set manually and subject to static self-learning)					
F00.02	Command source	1: Terminal control	1: Terminal control	1: Terminal control	1: Terminal control
F00.03	Terminal control mode	0: terminal RUN	0: terminal RUN	0: terminal RUN	0: terminal RUN
F00.04	Main frequency A	1: AI1 setting	0: Digital setting	1: AI1	1: AI1 setting
F00.05	Auxiliary frequency B	10: process PID	10: process PID		10: process PID
F00.06	Frequency source	6: Auxiliary frequency B + feedforward calculation	6: Auxiliary frequency B + feedforward calculation		6: Auxiliary frequency B + feedforward calculation
F00.07	Main frequency A setting		75.00Hz		
F00.14	Acceleration time	1.00s	1.00s	70.00s	1.00s
F00.15	Deceleration time	1.00s	1.00s	70.00s	1.00s

F00.16	Maximum frequency	75.00Hz	75.00Hz	75.00Hz	50.00Hz
F00.18	Upper frequency limit	75.00Hz	75.00Hz	75.00Hz	50.00Hz
F00.20	Reverse control	1: Prohibit reversing	0: Allow forward/reverse running	1: Prohibit reversing	0: Allow forward/reverse running
F02.00	X1 terminal	1: RUN	1: RUN	1: RUN	1: RUN
F02.01	X2 terminal	89: Reset feedforward	89: Reset feedforward	19: acceleration and deceleration time terminal 1	2: FR reverse
F02.02	X3 terminal	121: External material cutoff signal	121: External material cutoff signal	10: Reset protection	10: Reset protection
F02.03	X4 terminal	10: Reset protection	10: Reset protection	4: FJOG	26: Frequency source switching
F02.04	X5 terminal	9: free stop	9: free stop	9: free stop	121: External material cutoff signal
F02.57	AI1 filtering	0.05s	0.05s	0.05s	0.05s
F02.58	AI2 filtering	0.00s	0.00s	0.00s	0.00s
F03.00	Y1 Output	3:FDT1	3:FDT1	3:FDT1	68: Material cutoff detection

F03.02	R1 output	7: Inverter protection	7: Inverter protection	7: Inverter protection	7: Inverter protection
F03.08	Jog output control			0b01100: FDT jog without output	
F04.19	Stop mode	1: free stop	1: free stop	0: slow down to stop	1: free stop
F04.20	Starting frequency of DC braking in stop			2.50Hz	
F04.22	DC braking time in stop	3.00s	3.00s	3.00s	
F04.23	Demagnetization time for DC braking in stop	0.00s	0.00s	0.00s	
F05.11	Slip compensation gain	0.00%	0.00%	0.00%	
F05.00	VF curve selection				1
F05.02	VF voltage point V1				3.0%
F05.04	VF voltage				6.0%

	point V2				
F05.06	VF voltage point V3				15.0%
F07.11	Current limit				0: Invalid
F15.01	Jog acceleration time			8.00s	
F15.02	Jog deceleration time			8.00s	
F15.03	Acceleration time 2			70.00s	
F15.04	Deceleration time 2			5.00s	
F15.21	FDT1 setting	1.00Hz	1.00Hz	2.00Hz	1.00Hz
F15.22	FDT1 hysteresis	-1.50Hz	-1.50Hz	-1.00Hz	-1.50Hz
F15.23	FDT2	1.00Hz	1.00Hz	2.00Hz	1.00Hz
F15.24	FDT2 hysteresis	-1.50Hz	-1.50Hz	-1.00Hz	-1.50Hz
F15.30	Energy consumption braking	1: valid	1: valid	1: valid	1: valid
PID parameters					
F09.01	PID setting	5.0	5.0		5.0

F09.02	Feedback channel	2: AI2	2: AI2		2: AI2
F09.03	PID range	10.0	10.0		10.0
F09.05	Proportion 1	0.06	0.30		0.03
F09.06	Integral 1	0.000s	0.000s		4.000s
F09.07	Differential 1	30.000ms	30.000ms		30.000ms
F09.08	Proportion 2	0.10	0.40		0.07
F09.09	Integral 2	0.000s	0.000s		4.000s
F09.10	Differential 2	30.000ms	30.000ms		50.000ms
F09.11	Parameter switching mode	2: automatic switching according to deviation	3: Automatic switching by frequency		2: automatic switching according to deviation
F09.12	Deviation 1	5.00%	0.00%		5.00%
F09.13	Deviation 2	45.00%	100.00%		45.00%
F09.16	Upper limit of PID output				40.0%
F09.17	Lower limit of PID output	-50.0%	-50.0%		-40.0%
F09.19	Differential limit	1.00%	1.00%		0.50%
F09.21	PID setting change time	2.000s	2.000s		0.500s
F09.35	Upper limit	9.50V	9.50V		9.50V

	of feedback voltage				
F09.36	Lower limit of feedback voltage	0.50V	0.50V		0.50V
F09.37	Options of integral action of PID change setting				2: Start when the error is less than F09.38

Feedforward parameters and other settings

F27.01	Feedforward channel	1: Feedforward * main A	2: Feedforward *10V		1: Feedforward * main A
F27.02	Feedforward range	1:0.00 to upper limit	2: -upper limit to upper limit		0: No change in feedforward gain
F27.04	Upper limit of feedforward	500.00%	100.00%		500.00%
F27.05	Initial feedforward	50.00%	0.00%		100.00%
F27.13	Soft start increment	0.60%/s	0.70%/s		
F27.14	Feedforward increment 1	0.11%/s	0.18%/s		
F27.15	Feedforward increment 2	0.30%/s	0.50%/s		

F27.16	Feedforward increment 3	0.75%/s	1.30%/s		
F27.17	Feedforward increment 4	1.55%/s	2.75%/s		
F27.18	Feedforward increment 5	4.00%/s	7.40%/s		
F27.19	Feedforward increment 6	11.00%/s	20.50%/s		
F27.20	Material cutoff control	1201	101	1201	201

Wiring diagram of double-frequency wire drawing machine:

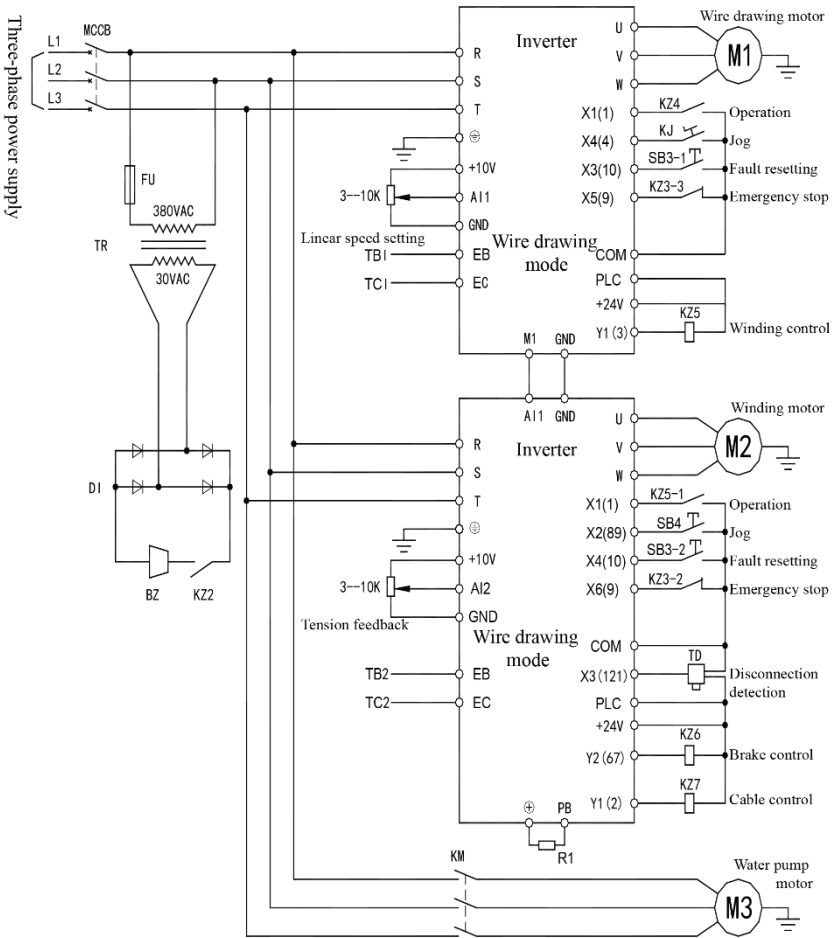

Note:

1. The output terminal function is not set to 67 by default (brake control function). For brake control of the inverter, set the related terminal function, and check whether F27.25 to F27.26 are appropriate.

2. The unwinding function is similar to the straight wire drawing machine. Refer to the wiring diagram of winding and list of parameter macros for wiring.

Electrical connection diagram:

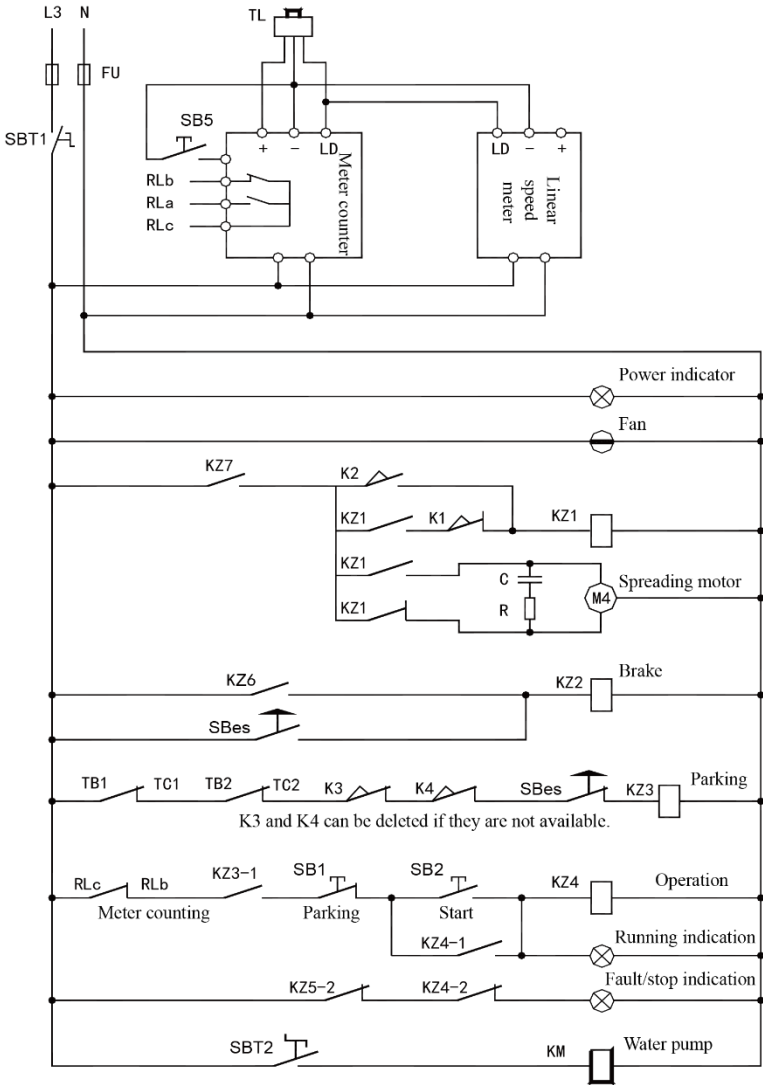

Function code	Function code name	Parameter description	Unit	Default setting	Attribute
F27.01	Feedforward gain action channel	0: feedforward gain * set source B 1: Feedforward gain * set source A 2: Feedforward gain * 10V		1	○

F27.01=0 Feedforward gain * set source B:

The feedforward gain acts on the set source B.

F27.01=1 Feedforward gain * set source A A:

The feedforward gain acts on the set source A.

F27.01=2 Feedforward gain *10V:

The feedforward gain is directly multiplied by Fmax and then superimposed on the output.

Function code	Function code name	Parameter description	Unit	Default setting	Attribute
F27.02	Feedforward gain input mode	0: No change in feedforward gain 1: 0.00 to upper limit of feedforward gain 2: - upper limit of feedforward gain to + upper limit of feedforward gain		1	○

F27.02=0 Unchanged feedforward gain:

The feedforward gain is always the set value of F27.05.

F27.02=1 0.00 to upper limit of feedforward gain:

The feedforward gain will be automatically adjusted between 0.00 and F27.04 settings.

F27.02=2 - Upper limit of feedforward gain to + upper limit of feedforward gain:

The feedforward gain will be automatically adjusted between -F27.04 and + F27.04 settings.



The unmarked settings are the same as those of F27.00=0 by default.

Function code	Function code name	Parameter description	Unit	Default setting	Attribute
F27.03	Feedforward control	Ones place: Feedforward reset option 0: automatic resetting 1: terminal resetting Tens place: Feedforward power-off stop option 0: save after power-off		10	○

		1: do not save after power-off Hundreds place: Continuous feedforward calculation 0: Not calculate 1: Continuous calculation			
--	--	---	--	--	--

Set the ones place of F27.03 to 0: automatic reset

Automatic reset: The feedforward gain is reset automatically after shutdown.

Set the ones place of F27.03 to 1: terminal reset

Terminal reset: The feedforward gain is reset by the terminal.

Set the tens place of F27.03 to 0: save after power failure

Save after power failure: When the feedforward gain is powered off and then powered on, the value before power failure will be restored.

Set the tens place of F27.03 to 1: not save after power failure

Not save after power failure: When the feedforward gain is powered off and then powered on, the initial feedforward gain will be restored.

Set the hundreds place of F27.03 to 0: not calculate (only for the straight wire drawing machine)

No calculation: When the DI input function “26: frequency source switching” of the external terminal is enabled, the feedforward calculation will not be continued.

Set the hundreds place of F27.03 to 1: calculate (only for the straight wire drawing machine)

No calculation: When the DI input function “26: frequency source switching” of the external terminal is enabled, the feedforward calculation will be continued.

Function code	Function code name	Parameter description	Unit	Default setting	Attribute
F27.04	Upper limit of feedforward gain	0.00~500.00	%	500.00	○

Upper limit of feedforward gain setting or change

Function code	Function code name	Parameter description	Unit	Default setting	Attribute
F27.05	Initial feedforward gain	0.00~500.00	%	50.00	●

Initial value of feedforward gain

Function code	Function code name	Parameter description	Unit	Default setting	Attribute
F27.06	Feedforward gain filter time	0~1000	ms	0	●

Under normal circumstances, it is not necessary to set the filtering of feedforward gain.

Function code	Function code name	Parameter description	Unit	Default setting	Attribute
F27.07	Feedforward range 0	0.00 to feedforward range 1	%	4.00	●
F27.08	Feedforward range 1	Feedforward range 0 to feedforward range 2	%	12.00	●
F27.09	Feedforward range 2	Feedforward range 1 to feedforward range 3	%	23.00	●
F27.10	Feedforward range 3	Feedforward range 2 to feedforward range 4	%	37.00	●
F27.11	Feedforward range 4	Feedforward range 3 to feedforward range 5	%	52.00	●
F27.12	Feedforward range 5	Feedforward range 4 to 100.00	%	72.00	●
F27.13	Soft start increment	0.00 - 50.00	%/s	0.60	●
F27.14	Feedforward increment 1	0.00 - 50.00	%/s	0.11	●
F27.15	Feedforward increment 2	0.00 - 50.00	%/s	0.30	●
F27.16	Feedforward increment 3	0.00 - 50.00	%/s	0.75	●
F27.17	Feedforward increment 4	0.00 - 50.00	%/s	1.55	●
F27.18	Feedforward increment 5	0.00 - 50.00	%/s	4.00	●
F27.19	Feedforward increment 6	0.00 - 50.00	%/s	11.00	●

F27.13 Soft start increment:

Feedforward change rate within the first period of F09.21.

F27.07 Feedforward increment 1:

Feedforward change rate corresponding to the deviation of F27.07-F27.08.

F27.12 Feedforward increment 6:

Feedforward change rate corresponding to the deviation of F27.12-100.00%..

Function code	Function code name	Parameter description	Unit	Default setting	Attribute
F27.20	Material cutoff control mode	Ones place: Disconnection detection mode 0: Automatic detection		11211	○

		<p>1: External signal</p> <p>Tens place: Material cutoff detection control</p> <p>0: Detect when the output is greater than the lower limit of material cutoff detection</p> <p>1: no detection</p> <p>Hundreds place: Material cutoff handling mode</p> <p>0: Protection of terminal action only</p> <p>1: Delayed stop and protection report</p> <p>2: Material cutoff protection</p> <p>3: Automatic reset of material cutoff protection</p> <p>4: Material cutoff detection terminal output only</p> <p>5: Automatic reset of material cutoff detection terminal</p> <p>Thousands place: Brake mode</p> <p>0: mode 0</p> <p>1: mode 1</p> <p>Myriabit: Reverse unwinding mode</p> <p>0: No speed limit</p> <p>1: Reverse speed limit by F27.24</p>			
--	--	--	--	--	--

Ones place of F27.20 = 0: automatic detection

Wire disconnection is detected automatically by the inverter. In this mode, F09.35 and F09.36 must be set accurately.

Ones place of F27.20 = 1: external signal

Wire disconnection is detected by the external proximity switch.

Tens place of F27.20 = 0: Detection with the output greater than the lower limit of material cutoff detection

When the stop command is received, and the output frequency is less than the set value of F27.22, wire disconnection will not be detected.

Tens place of F27.20 = 1: no detection

Wire disconnection will not be detected.

Hundreds place of F27.20 = 0: Protection terminal action only

In case of wire disconnection, the inverter will continue to run at the set frequency of F27.24, and only the 68# function terminal and protection output terminal will act.

Hundreds place of F27.20 = 1: Delayed stop and trip protection

In case of wire disconnection, the 68# function terminal and protection output terminal will act, the inverter will stop after running at the frequency of F27.24 for the time of F27.23 and then the protection will be enabled.

Hundreds place of F27.20 = 2: Material cutoff protection

In case of wire disconnection, the inverter will be in the protection status.

Hundreds place of F27.20 = 3: Automatic reset of material cutoff protection

In case of wire disconnection, the inverter will be in the protection status and reset automatically after the set delay time of F27.26.

Hundreds place of F27.20 = 4: Only output of material cutoff detection terminal (for the straight wire drawing machine only)

In case of wire disconnection, the inverter will not be subject to trip protection, and only the output terminal for material cutoff detection output will be valid.

Hundreds place of F27.20 =5: Automatic resetting of material cutoff detection terminal (for the straight wire drawing machine only)

This is the same as the option 4. The terminal of material cutoff detection output is invalid only when the swing rod returns to the normal range.

Thousands place of F27.20 = 0: Mode 0

Mode 0: When the output frequency is within the brake signal output frequency (F27.25) from top to bottom, the brake will not work.

Thousands place of F27.20 = 1: Mode 1

Mode 1: When the output frequency is within the brake signal output frequency (F27.25) from top to bottom, the brake will work.

Ten hundreds places of F27.20 = 0: no speed limit

There is no reverse speed limit.

Ten hundreds places of F27.20 = 1: reverse speed limit by F27.24

There is no reverse speed limit by F27.24.

Function code	Function code name	Parameter description	Unit	Default setting	Attribute
F27.21	Material cutoff detection delay	0.0~10.0	s	6.0	●

When the inverter receives the running command, wire disconnection detection will be performed after the set time.

Function code	Function code name	Parameter description	Unit	Default setting	Attribute
F27.22	Lower limit of material cutoff detection after parking	0.00 - 60.00	Hz	5.00	●

If the tens place of F27.20 is set to 0 and the inverter decelerates to this frequency, wire

disconnection will not be detected.

(This function will not be enabled until the output frequency of the inverter must exceed this frequency after the soft start time and be lower than this frequency after deceleration.)

Function code	Function code name	Parameter description	Unit	Default setting	Attribute
F27.23	Time of continuous running after material cutoff	0.0 - 60.0	s	10.0	●
F27.24	Frequency of continuous running after material cutoff	0.00~Fmax	Hz	5.00	●

The set time of F27.23 is calculated when the wire disconnection is identified. According to the setting of F27.24, the operating frequency in this period is reverse during unwinding and positive during winding.

Function code	Function code name	Parameter description	Unit	Default setting	Attribute
F27.25	Brake signal output frequency	0.00~Fup	Hz	2.50	●
F27.26	Braking signal duration	0.0-100.0	s	5.0	●

F27.25 and F27.26 are not valid until one output terminal is defined as “brake control” (67# function).

When the output frequency of the inverter drops to the set value of F27.25, the brake control terminal will be valid and maintained (the brake mode 1 is enabled).

It will be invalid after the set time of F27.26. When the brake control terminal is valid, the inverter will stop freely.

There is no response to the running command when the brake control terminal is valid.

If F27.26 is set to 0.0, the brake control terminal will remain valid and can be reset by the brake reset terminal or protection reset terminal.

Function code	Function code name	Parameter description	Unit	Default setting	Attribute
F27.27	Minimum frequency of wiring detection	0.00~20.00	Hz	10.00	●
F27.28	Judgment time for invalid cable signal	0.1 - 20.0	s	10.0	●

F27.29	Judgment time for valid cable signal	0.1 - 20.0	s	2.0	●
--------	--------------------------------------	------------	---	-----	---

When the input terminal is set to “122: wiring detection signal”, F27.27-F27.29 will be valid.

When the output frequency of the inverter reaches the set value of F27.27, wiring detection will be started.

If the wiring detection terminal is valid within the set time of F27.28, the wiring switch will be considered invalid.

If the wiring detection terminal is always valid within the set time of F27.29, the wiring pole will stop moving.

If the wiring pole protection is detected, the inverter will report E44 protection and stop freely.

Function code	Function name	Parameter description	Unit	Default setting	Attribute
F27.30	Filtering time for material cutoff detection	1 - 100	ms	5	●

The set time of this function is the filtering time of material cutoff detection. It is valid simultaneously for automatic material cutoff detection and external material cutoff detection.

Function code	Function name	Parameter description	Unit	Default setting	Attribute
F27.36	Current value of feedforward gain	-500.0~500.0	%		×

This function code is used to view the current feedforward gain.

Chapter 8 Motor Parameter Self-identification

8.1 Motor Parameter Self-identification

When the vector control mode is selected, the motor parameters must be self-identified. For non-vector control, it is recommended to perform parameter self-identification during the first run in order to improve the control accuracy.

The motor parameters required for calculation in vector control are usually not available to users. The EM730/EM730E series inverter has the function of motor parameter self-identification. When the self-identification is enabled, the inverter will automatically test

the relevant parameters of the connected motor and store them into the internal memory. Fig. 8-18 shows the specific meanings of the parameters of the three-phase asynchronous motor.

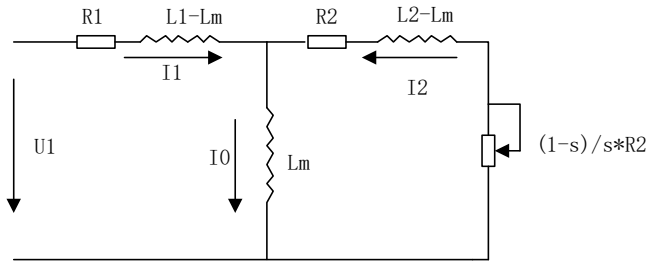

Fig. 8-18 Equivalent Circuit of Three-phase Asynchronous Motor

$R1$, $R2$, $L1$, $L2$, Lm , and $I0$ in the figure represent: stator resistance, rotor resistance, stator self-inductance, rotor self-inductance, mutual inductance, and no-load excitation current. The leakage inductance is $Ls=L-Lm$.

8.2 Precautions before Self-identification

- Motor parameter self-identification is a process of automatically measuring motor parameters. The EM730/EM730E series inverter can perform the static and rotary self-identification of motor parameters.
 - The static self-identification is applicable when the motor load cannot be removed but the motor parameters are available.
 - The rotary self-identification is suitable when the motor load can be removed. The motor shaft needs to be disconnected from the load before operation. The rotary self-identification must not be performed when the motor is under load.
- Prior to self-identification, make sure that the motor is stopped; otherwise, self-identification cannot be performed properly.
- Self-identification is valid only in the keyboard control mode (i.e. F00.02=0).
- In order to ensure the normal self-identification of motor parameters, the nameplate parameters (F01.00: motor type; F01.01: rated power of the motor; F01.02: rated voltage of the motor; F01.03: rated current of the motor; F01.04: rated frequency of the motor; F01.05: rated speed of the motor; F01.06: winding connection of the motor; F01.07: rated power factor of the motor) of the controlled motor should be set correctly. When the Y series motor is used based on the specified power of the inverter, its default settings can meet



most requirements.

- In order to ensure the control performance, the power of the motor should match with that of the inverter, or the former should be one level lower than the latter under normal circumstances.
- After the normal self-identification of motor parameters, the set values of F01.09 to F01.13 and F01.19 to F01.22 will be updated and automatically saved.
- When F12.14=1 is restored to the default setting, the values of the function codes F01.00 to F01.13 and F01.19 to F01.22 remain unchanged.



8.3 Self-identification Steps



- Set F00.02=0 in the parameter setting status and disconnect the motor from the load.
- According to the motor nameplate parameters, set F01.00 (motor type), F01.01 (rated power of the motor), F01.02 (rated voltage of the motor), F01.03 (rated current of the motor), F01.04 (rated frequency of the motor), F01.05 (rated speed of the motor), F01.06 (winding connection of the motor) and F01.07 (rated power factor of the motor), respectively.

- For the asynchronous motor:

Set F01.34=1 and press . The inverter will start the static self-identification of the motor. Or, set F01.34=2 and press . The inverter will start the rotary self-identification of the motor.

- For the synchronous motor:

Set F01.34=11 and press . The inverter will start the static self-identification of the motor. Or, set F01.34=12 and press . The inverter will start the rotary self-identification of the motor.

- It takes about two minutes to complete the self-identification of the motor. Then the system will return to the initial power-on status.
- During the self-identification, if you press the STOP/RESET key , “E24” (parameter identification abnormality) will be displayed; and if you press the STOP/RESET key , the system will return to the parameter setting status.

If the self-identification fails, “E24” (parameter identification abnormality) will be displayed. If the STOP/RESET key is pressed , the system will return to the parameter setting status.

Chapter 9 Protection/Warning Solutions

9.1 Protection content

When the inverter is in the abnormal status, the digital tube display will show the corresponding protection code and its parameters, the protection relay and protection output terminal will work, and the inverter will stop the output. In case of protection, the motor will stop rotating normally or slow down until it is stopped. The protection contents and solutions of the EM730/EM730E series inverter are shown in Table Table 9-26.

Table 9-26 Protection Contents and Solutions of EM730/EM730E Series Inverter

Protection code	Protection Type	Protection Cause	Protection Solution
<i>E01</i>	Short circuit protection	<ol style="list-style-type: none"> 1. Short circuit to the ground. 2. Inter-phase short circuit 3. Short circuit of the external braking resistor. 4. The acceleration and deceleration time is too short. 5. The inverter module is damaged. 6. There is excessive on-site interference. 	<ol style="list-style-type: none"> 1. Check the wiring for short circuits. 2. Properly increase the acceleration and deceleration time. 3. Investigate the cause and reset the controller after implementing the corresponding solutions. 4. Seek technical support.
<i>E02</i>	Instantaneous overcurrent	<ol style="list-style-type: none"> 1. The acceleration and deceleration time is too short. 2. In the V/F drive mode, the V/F curve setting is unreasonable. 3. The motor is running during startup. 4. The motor used is beyond the capacity of the inverter or the load is too heavy. 5. Motor parameters are not suitable and need to be identified. 6. The phases on the output side of the inverter are short-circuited. 7. The inverter is damaged. 	<ol style="list-style-type: none"> 1. Increase the acceleration and deceleration time. 2. Reasonably set the V/F curve. 3. Enable speed tracking or start DC braking. 4. Use the appropriate motor or inverter. 5. Identify the motor parameters. 6. Check the wiring for short circuits. 7. Seek technical support.

E04	Steady-state overcurrent	The same as E02	The same as E02
E05	Overvoltage	<ol style="list-style-type: none"> 1. The deceleration time is too short, and the motor has too much regenerated energy. 2. The braking unit or braking resistor forms an open circuit. 3. The braking unit or braking resistor does not match. 4. The power voltage is too high. 5. The energy consumption braking function is not enabled 	<ol style="list-style-type: none"> 1. Increase the deceleration time. 2. Check the wiring of the braking unit and braking resistor. 3. Use a suitable braking unit/braking resistor. 4. Reduce the power voltage to the specified range. 5. For the model of the built-in braking unit, set F15.30 to 1, and enable the energy consumption braking.
E06	Undervoltage	<ol style="list-style-type: none"> 1. The input power supply is subject to phase loss. 2. The terminals of the input power supply are loose. 3. The voltage of the input power supply drops too much. 4. The switch contacts of the input power supply are aging. 	<ol style="list-style-type: none"> 1. Check the input power supply and wiring. 2. Tighten the screws of input terminals. 3. Check the air circuit breaker and contactor.
E07	Input phase loss	<ol style="list-style-type: none"> 1. The input power supply is subject to phase loss. 2. The input power supply fluctuates greatly. 	<ol style="list-style-type: none"> 1. Check the input power supply. 2. Check the wiring of the input power supply. 3. Check whether the terminal is loose 4. Use a voltage regulator on the input side.
E08	Output phase loss	<ol style="list-style-type: none"> 1. The output terminals U, V and W have phase losses. 	<ol style="list-style-type: none"> 1. Check the connection between the inverter and motor. 2. Check whether the output terminal is loose. 3. Check whether the motor winding is disconnected.
E09	Inverter overload	<ol style="list-style-type: none"> 1. The acceleration and deceleration time is too short. 2. In the V/F drive mode, the V/F curve setting is unreasonable. 3. The load is too heavy. 4. The braking time is too long, the braking intensity is too high, or DC braking is enabled repeatedly. 	<ol style="list-style-type: none"> 1. Increase the acceleration and deceleration time. 2. Reasonably set the V/F curve. 3. Use the inverter that matches the load. 4. Reduce the braking time and braking intensity. Do not enable DC braking repeatedly.

<i>E 10</i>	Inverter overheat	<ol style="list-style-type: none"> 1. The ambient temperature is too high. 2. The inverter is subject to poor ventilation. 3. The cooling fan fails. 	<ol style="list-style-type: none"> 1. The operating environment of the inverter should meet the specifications. 2. Improve the ventilation environment and check whether the air duct is blocked. 3. Replace the cooling fan.
<i>E 11</i>	Parameter setting conflict	<ol style="list-style-type: none"> 1. There is a logic conflict in parameter settings. 	<ol style="list-style-type: none"> 1. Check whether parameters set is illogical before the protection.
<i>E 13</i>	Motor overload	<ol style="list-style-type: none"> 1. The acceleration and deceleration time is too short. 2. In the V/F drive mode, the V/F curve setting is unreasonable. 3. The load is too heavy. 	<ol style="list-style-type: none"> 1. Increase the acceleration and deceleration time. 2. Reasonably set the V/F curve. 3. Use a motor matching the load.
<i>E 14</i>	External protection	<ol style="list-style-type: none"> 1. The protection terminal of the external device acts. 	<ol style="list-style-type: none"> 1. Check the external device.
<i>E 15</i>	Inverter memory protection	<ol style="list-style-type: none"> 1. Interference results in memory reading and writing errors. 2. The internal memory of the controller is read and written repeatedly, causing damage to the memory. 	<ol style="list-style-type: none"> 1. Press the STOP/RESET key to reset the controller and try again. 2. For the parameters (e.g. frequency setting) to be modified frequently, set F10.56 to 11 after debugging.
<i>E 16</i>	Communication error	<ol style="list-style-type: none"> 1. Communication timeout is enabled in the discontinuous communication system. 2. Communication is disconnected. 	<ol style="list-style-type: none"> 1. F10.03 is set to 0.0 in the discontinuous communication system. 2. Adjust the F10.03 communication timeout. 3. Check whether the communication cable is disconnected.
<i>E 17</i>	Abnormality of inverter temperature sensor	The inverter temperature sensor is disconnected or short-circuited.	<ol style="list-style-type: none"> 1. Check whether the inverter temperature sensor is connected properly. 2. Seek technical support.
<i>E 18</i>	The soft start relay is not engaged.	<ol style="list-style-type: none"> 1. The power supply fails during operation. 2. The input power supply is subject to phase loss. 3. The terminals of the input power supply are loose. 4. The voltage of the input power supply drops too much. 5. The switch contacts of the input power supply are aging. 	<ol style="list-style-type: none"> 1. Stop the inverter before power-off, or directly reset the protection. 2. Check the input power supply and wiring. 3. Tighten the screws of input terminals. 4. Check the air circuit breaker and contactor.

<i>E19</i>	Error of current detection circuit	The detection circuit of the drive board or control board is damaged.	1. Seek technical support.
<i>E20</i>	Stall protection	<ol style="list-style-type: none"> 1. The deceleration time is too short. 2. Error of dynamic brake for deceleration. 3. The load is too heavy. 	<ol style="list-style-type: none"> 1. Increase the deceleration time. 2. Check the dynamic brake. 3. Check whether the motor cannot be stopped as it is driven by another load.
<i>E21</i>	PID feedback disconnection	1. The PID feedback is greater than the upper limit (F09.24) or less than the lower limit (F09.25), depending on the type of the feedback sensor.	<ol style="list-style-type: none"> 1. Check whether the feedback line falls off. 2. Check whether the sensor is working abnormally. 3. Adjust the detection value of feedback disconnection to a reasonable level.
<i>E24</i>	Self-identification error	<ol style="list-style-type: none"> 1. Press the STOP/RESET key during parameter identification. 2. The external terminal stops working (FRS = ON) properly during parameter identification. 3. The motor is not connected. 4. The rotary self-learning motor is not disconnected from the load. 5. The motor fails. 	<ol style="list-style-type: none"> 1. Press the STOP/RESET key to reset. 2. The external terminal should not be operated during parameter identification. 3. Check the connection between the inverter and motor. 4. Disconnect the rotary self-learning motor from the load. 5. Check the motor.
<i>E26</i>	Load loss protection	<ol style="list-style-type: none"> 1. The motor is not connected or does not match the load. 2. Load loss occurs. 3. The parameters of load loss protection are not set reasonably. 	<ol style="list-style-type: none"> 1. Check the wiring and use the appropriate motor 2. Check the equipment. 3. Change the off-load detection level F07.22 and detection time F07.23.
<i>E27</i>	Up to cumulative power-on time	1. The inverter maintenance time is up.	1. Please contact the dealer for technical support.
<i>E28</i>	Up to cumulative running time	1. The inverter maintenance time is up.	1. Please contact the dealer for technical support.
<i>E44</i>	Wiring protection	<ol style="list-style-type: none"> 1. The valid time of the wiring detection terminal is too long. 2. The invalid time of the wiring detection terminal is too long. 	<ol style="list-style-type: none"> 1. Check whether the sensor can work normally. 2. Check whether the terminal is capable of properly judging the closing and opening.
<i>E57</i>	Overpressure in pipeline network	1. The feedback pressure in the water supply application is too	1. Check whether the sensor is in the abnormal status.

		high.	2. Check the analog terminal for normal detection of analog input. 3. Check the external device.
<i>E58</i>	Under-pressure in pipeline network	1. The feedback pressure in the water supply application is too low.	1. Check whether the sensor is in the abnormal status. 2. Check the analog terminal for normal detection of analog input. 3. Check the external device.
<i>E76</i>	Short circuit to the ground	1. The output is short-circuited to ground. 2. The inverter module is damaged.	1. Check whether the output cable is broken or whether the motor shell is broken down. 2. Investigate the cause and reset the controller after implementing the corresponding solutions. 3. Seek technical support.

When the inverter is subject to the aforesaid protection, press the STOP/RESET key  to reset/clear protection or use the protection resetting terminal to exit the protection status. If the protection has been eliminated, the inverter will return to the function setting status; otherwise, the digital tube will continue to display the current protection information.

The protection number corresponds to the digit behind the letter “E”. For example, the digit corresponding to “EXX” is “XX”.

For example, E01 corresponds to 1, and E10 corresponds to 10.

Comparison table of digital font display:

<i>1</i>	<i>2</i>	<i>3</i>	<i>4</i>	<i>5</i>	<i>6</i>	<i>7</i>	<i>8</i>	<i>9</i>	<i>0</i>
1	2	3	4	5	6	7	8	9	0

The prompt codes and description of inverter operation are as follows:

Prompt Code	Description
<i>P. -ON</i>	The inverter is in the power-on status.
<i>P. -OFF</i>	The inverter is in the power-off status.
<i>Soft. E</i>	If the soft starter is not engaged, the inverter will show the SOFT.E prompt after startup. When the voltage is restored and the soft starter is engaged, the inverter will work normally.

9.2 Protection analysis

If the motor does not work as expected due to errors in function setting and external control terminal connection after the inverter is powered on, refer to the analysis in this section for the corresponding solutions. If a protection code is displayed, see the solutions in 9.1.

9.2.1 Failure in parameter setting of function codes

- The displayed parameters remain unchanged during the forward or reverse spinning of the digital potentiometer.

When the inverter is in the running status, some code parameters cannot be modified without stopping the inverter.

- The displayed parameters can be modified but cannot be stored during the forward or reverse spinning of the digital potentiometer.

Some function codes are locked and cannot be modified.

When F12.02 is set to 1 or 2, parameter changes are restricted. Please set F12.02 to 0. Or, this occurs after the user password is set.

9.2.2 Abnormality of motor rotation

- When the RUN key  on the keyboard is pressed, the motor does not rotate.
 - Terminal control of the start and stop: Check the setting of the function code F00.02.
 - The free stop terminal FRS and COM are closed: Disconnect the free stop terminal FRS from COM.
 - Switching of the running command to terminal is valid. In this case, the running command is only subject to terminal control. This will be invalid if modified.
 - The status combination of the running command channel is terminal control: Change it to keyboard control.
 - The reference input frequency is set to 0: Increase the reference input frequency.
 - The input power supply is abnormal or the control circuit fails.
- The control terminals RUN and F/R are ON, and the motor does not rotate.
 - Enabling of the stop function by the external terminal is invalid: Check the setting of function code F00.02.
 - Free stop terminal FRS=ON: Change the free stop terminal to FRS=OFF.
 - Control switch failure: Check the control switch.

- The reference input frequency is set to 0: Increase the reference input frequency.
- The motor can only rotate in one direction.

Reverse running is prohibited: When the reverse running prohibition code F00.21 is set to 1, the inverter is not allowed for reverse running.
- The motor rotates in the opposite direction.

The output phase sequence of the inverter is inconsistent with the input phase sequence of the motor: Exchange any two of the motor wires in the power-off status to change the rotation direction of the motor.

9.2.3 Too long acceleration time of motor

- The current limit level is too low.

When the overcurrent limit setting is valid, and the output current of the inverter reaches the set current limit, the output frequency will remain unchanged during acceleration, until the output current is less than the limit. Then the output frequency will continue to rise. This makes the acceleration time of the motor longer than the set time. Check whether the set current limit of the inverter is too low.
- The set acceleration time is too long. Please check the acceleration time code.

9.2.4 Too long deceleration time of motor

- When energy consumption braking is valid:
 - The resistance of the braking resistor is too high, and the energy consumption braking power is too low, which extends the deceleration time.
 - The set value of braking rate (F15.32) is too small, which extends the deceleration time. Increase the set value of braking rate.
 - The set deceleration time is too long. Check the deceleration time code.
- When the stall protection is valid:
 - When the overvoltage stall protection is enabled, and the DC bus voltage exceeds the voltage of overvoltage stall (F07.07), the output frequency will remain unchanged; and when the DC bus voltage is lower than F07.07, the output frequency will continue to drop, which extends the deceleration time.
 - The set deceleration time is too long. Check the deceleration time code.

9.2.5 Electromagnetic interference and RF interference

- Since the inverter works in the high-frequency switching status, electromagnetic

interference and RF interference will be generated to the control device. The following measures can be taken.

- Reduce the carrier frequency (F00.23) of the inverter.
- Install a noise filter on the input side of the inverter.
- Install a noise filter on the output side of the inverter.
- Install a metal tube outside the cables. Install the inverter in a metal casing.
- Make the inverter and motor grounded reliably.
- Connect the main circuit and control circuit separately. Use the shielded cables in the control circuit, and connect them according to the wiring method in Chapter 3.

9.2.6 Action of leakage circuit breaker

- When the inverter is running, the leakage circuit breaker works.

Since the inverter outputs high-frequency PWM signals, a high-frequency leakage current will be generated. Please use the dedicated leakage circuit breaker with the current sensitivity above 30 mA. If an ordinary leakage circuit breaker is used, use a leakage circuit breaker with the current sensitivity above 200 mA and action time of more than 0.1 s.

9.2.7 mechanical vibration

- The inherent frequency of the mechanical system resonates with the carrier frequency of the inverter.

The motor is not faulty, but the mechanical system produces sharp resonant sounds. This is caused by the resonance between the inherent frequency of the mechanical system and carrier frequency of the inverter. Please adjust the carrier frequency (F00.23) to avoid resonance.

- The inherent frequency of the mechanical system resonates with the output frequency of the inverter.

Resonance between the inherent frequency of the mechanical system and output frequency of the inverter will lead to mechanical noise. Please use the vibration suppression function (F05.13), or install the anti-vibration rubber or take other anti-vibration measures on the motor base.

- PID control oscillation

The adjustment parameters P, Ti and Td of the PID controller are not set correctly. Please set the PID parameters again.

9.2.8 Motor rotation in the absence of inverter output

- Insufficient DC braking for stop
 - The DC braking torque for stop is too small. Please increase the set value of the DC braking current for stop (F04.21).
 - The DC braking time for stop is short. Please increase the set value of the DC braking time for stop (F04.22). Under normal circumstances, please give priority to increase in the DC braking current for stop.

9.2.9 Inconsistency between output frequency and set frequency

- The set frequency exceeds the upper frequency limit.

When the set frequency exceeds the set value of the upper frequency limit, the output frequency will be the upper frequency limit. Set the frequency again within the upper frequency limit range; or check whether F00.16, F00.17 and F00.18 are appropriate.

Maintenance

9.3 Daily Maintenance of Inverter

The inverter may be subject to various faults due to changes in its operating environment, such as the impact of temperature, humidity, smoke, dust and the like, and ageing of internal components. Thus, daily inspection and regular maintenance should be carried out to the inverter during storage and operation.

- Check whether the components of the inverter are intact and whether the screws are tightened after transportation and before operation.
- During the normal operation of the inverter, clean dust on a regular basis and check whether the screws are tightened.
- If the inverter is not in use for a long time, it is recommended to power it on (preferably 30 min) once every six months during storage, to prevent the failure of electronic components.
- The inverter should not be used in the humid place or place with metal dust. If necessary, use the inverter in an electrical cabinet with protective measures or an on-site protective cabin.

Please check the following items during the normal operation of the inverter:

- Check the motor for abnormal sound and vibration.
- Check the inverter and motor for abnormal heating.
- Check whether the ambient temperature is too high.
- Check whether the output current is normal.
- Check whether the cooling fan of the inverter works properly.

Depending on the usage, the user needs to check the inverter on a regular basis to eliminate faults and safety hazards. Prior to the inspection, turn off the power supply and wait until the LED indicator of the keyboard is OFF, and then wait for 10min. The check content is shown in Table Table 4-27.

Table 4-27 Content of Regular Inspection

Check Item	Check Content	Solution
Screws of main circuit terminals and control circuit terminals	Check whether the screws are loose.	Tighten the screws with a screwdriver.
Cooling fins PCB (printed circuit board)	Check whether there is dust or foreign objects.	Purge them with dry compressed air (pressure: 4-6 kg/cm ²).
Cooling fan	Check it for abnormal noise and vibration. Check whether the cumulative running time is up to 20,000 hours.	Replace the cooling fan
Power components	Check whether there is dust.	Purge them with dry compressed air (pressure: 4-6 kg/cm ²).
Electrolytic capacitor	Check it for color changes, odor and bubbles.	Replace the electrolytic capacitor.

In order to make the inverter work properly in a long time, regular maintenance and replacement must be performed regularly based on the service life of its internal components. The service life of the components of the inverter varies depending on the operating environment and conditions. The replacement period of the inverter in Table 4-28 is for reference only.

Table 4-28 Replacement Intervals of Inverter Components

Name of Part	Standard Replacement Interval (Year)
Cooling fan	2-3 years
Electrolytic capacitor	4-5 years
Printed circuit board	5-8 years

The operating conditions for replacement of the inverter components listed in the above table are as follows:

Ambient temperature: Annual average 30°C.

Load factor: Less than 80%.

Operating time: less than 12 hours per day.

9.4 Instructions for Inverter Warranty

Our company will provide warranty services for the inverter in the following cases.

The warranty applies to the inverter body only. Our company is responsible for the warranty of the inverter that fails or is damaged within 12 months during normal operation, and will charge reasonable maintenance fees after 12 months.

Certain maintenance fees will also be charged within one year in the following cases:

- The inverter is damaged due to noncompliance with the instructions in this manual during operation;
- The inverter is damaged due to flood, fire, abnormal voltage, etc.;
- The inverter is damaged as a result of incorrect wiring;
- The inverter is damaged due to unauthorized modification.

Relevant service fees will be calculated based on the actual costs.

If any, the additional agreement shall prevail.

Chapter 10 Select accessories

10.1 Braking Resistor

If the speed of the controlled motor drops too fast or the motor load shakes too fast during the inverter operation, its electromotive force will charge the internal capacitor reversely via the inverter, resulting in the voltage boost at two ends of the power module. This is likely to cause damage to the inverter. The internal control of the inverter will suppress this based on the load. If the braking performance does not meet the customer requirements, an external braking resistor is needed to release energy in a timely manner. Due to the external braking resistor of energy consumption braking type, the energy will be completely dissipated to the power braking resistor. Hence, the power and resistance of the braking resistor must be selected reasonably and effectively.

The power of the braking resistor can be calculated by the following formula:

Resistor power P_b = inverter power P × braking frequency D

D - Braking frequency. This is an estimated value, depending on the load conditions. Under normal circumstances, D is as follows:

$D=10\%$ under ordinary loads

$D=5\%$ for occasional braking loads

$D = 10\%$ to 15% for elevators

$D = 5\%$ to 20% for centrifuges

$D = 10\%$ to 20% for oilfield kowtow machines

$D = 50\%$ to 60% for unwinding and winding. It should be calculated based on the system design indicators.

D = 50% to 60% for lifting equipment with a lowering height over 100m

The recommended power and resistance for the braking resistor of the EM730/EM730E series inverter are given in the table below. The recommended resistor power is calculated based on the braking rate (10% to 20%). It is for reference only. If the inverter is used in the case of frequent acceleration/deceleration or continuous braking, the power of the braking resistor needs to be increased. The user can change the value according to the load conditions, but within the specified range.

Inverter Model	Motor (kW)	Resistance (Ω)	Resistor Power (W)	Wire (mm ²) Connected to Resistor
EM730/EM730E-0R4-2B	0.4	$\cong 360$	$\cong 200$	1
EM730/EM730E-0R7-2B	0.75	$\cong 180$	$\cong 400$	1.5
EM730/EM730E-1R5-2B	1.5	$\cong 180$	$\cong 400$	1.5
EM730/EM730E-2R2-2B	2.2	$\cong 90$	$\cong 800$	2.5
EM730/EM730E-0R7-3B	0.75	$\cong 360$	$\cong 200$	1
EM730/EM730E-1R5-3B	1.5	$\cong 180$	$\cong 400$	1.5
EM730/EM730E-2R2-3B	2.2	$\cong 180$	$\cong 400$	1.5
EM730/EM730E-4R0-3B	4	$\cong 90$	$\cong 800$	2.5
EM730/EM730E-5R5-3B	5.5	$\cong 60$	$\cong 1000$	4
EM730/EM730E-7R5-3B	7.5	$\cong 60$	$\cong 1000$	4
EM730/EM730E-011-3B	11	$\cong 30$	$\cong 2000$	6
EM730/EM730E-015-3B	15	$\cong 30$	$\cong 2000$	6
EM730/EM730E-018-3B	18.5	$\cong 30$	$\cong 2000$	6
EM730/EM730E-022-3B	22	$\cong 15$	$\cong 4000$	6
EM730/EM730E-030-3B	30	$\cong 10$	$\cong 4000$	6
EM730/EM730E-037-3B	37	$\cong 10$	$\cong 6000$	6

- ★ The wires listed above refer to the outgoing wires of a single resistor. If resistors are connected in parallel, the bus should be enlarged accordingly. The withstand voltage of the wires should be AC300V or above for the single-phase model and AC450V or above for the three-phase model. Cables should be resistant to 105°C.

10.2 Braking unit

For the EM730/EM730E series inverters (EM730/EM730E-045-3 and above), use our BR100 series braking units (power range: 18.5-160kW). The models of our braking units are as follows.

Model and specification	Application	Minimum Resistance (Ω)	Average Braking Current I_{av} (A)	Peak Current I_{max} (A)	Applicable Inverter Power (kW)
BR100-045	Energy consumption braking	10	45	75	18.5 - 45
BR100-160	Energy consumption braking	6	75	150	55 - 160

★ When BR100-160 works with the minimum resistance, the braking unit can work continuously at the braking frequency $D=33\%$.

In the case of $D>33\%$, intermittent operation will be performed; otherwise, the over-temperature protection will be enabled.

10.2.1 Selection of Connecting Wires

Since all braking units and braking resistors work at high voltage ($>400VDC$) and in the discontinuous status, please select appropriate wires. See Table 4-29 for the wiring specifications of the main circuit. Use the cables with the conforming insulation levels and cross-sections.

Table 4-29 Wire Specifications of Braking Units and Braking Resistors

Specification and model	Average Braking Current I_{av} (A)	Peak Braking Current I_{max} (A)	Cross-section (mm^2) of Copper-core Cable
BR100-045	45	75	10
BR100-160	75	150	16
BR100-315	120	300	25

Flexible cables have higher flexibility. Because cables may be in contact with high-temperature devices, it is recommended to use copper-core and heat-resistant flexible cables or flame-retardant cables. The braking unit should be close to the inverter as much as possible and no more than 2m far away from the inverter. Otherwise, the DC-side cables should be twisted and used with magnetic rings to reduce radiation and inductance.

The lengths of connecting wires of the braking unit, braking resistor and inverter are shown in Fig. 4-19.

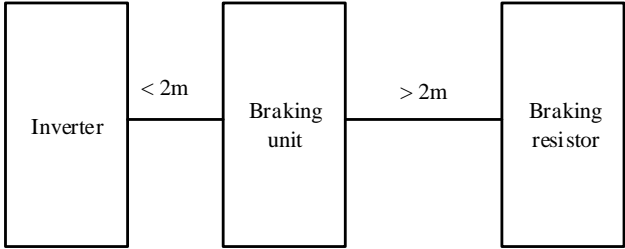

Fig. 4-19 Wire Length

10.3 Wi-Fi module

Applicable Wi-Fi module and model for EM730/EM730E series inverters: EM730-WIFI. The inverter can be controlled by the mobile phone APP, PC background software and the like for quick parameter setting, parameter copying and status monitoring of the inverter.

Installation of the Wi-Fi module: First unplug the keyboard from the inverter and then install the Wi-Fi module to the original keyboard position.

The external schematic diagram of the Wi-Fi module is as follows.



Chapter 11 MODBUS Communication Protocol

11.1 Applicable scope

- 1、 Applicable series: EM730/EM730E series
- 2、 Applicable network: Support the “single-master multi-slave” communication network with MODBUS-RTU protocol and RS-485 bus.

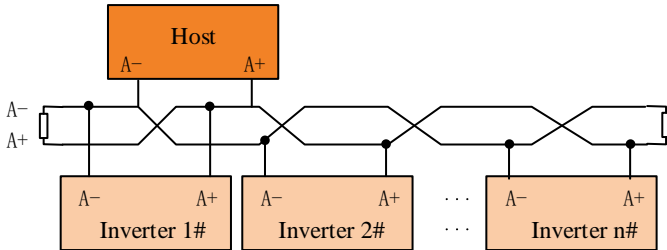

11.2 Interface mode

RS-485 asynchronous half-duplex communication mode, with the least significant bit sent first;

RS-485 network address: 1-247; 0 is the broadcast address;

Default data format of RS-485 terminal: 1-8-N-1² (options: 1-8-E-1, 1-8-O-1, 1-8-N-2, 1-8-E-2 and 1-8-O-2);

Default baud rate of RS-485 terminal: 9600bps (options: 4800bps, 19200bps, 38400bps, 57600bps and 115200bps)

It is recommended to use twisted-pair shielded cable as the communication cable to reduce the impact of external interference on communication.

[2]: 1-8-N-1, meaning 1 start bit - 8 characters per byte of data - no parity - 1 stop bit. E: even parity. O: odd parity.

11.3 Protocol Format

11.3.1 Message format

As shown in Fig. 12-20, a standard MODBUS message includes a start tag, RTU (Remote Terminal Unit) message, and end tag.

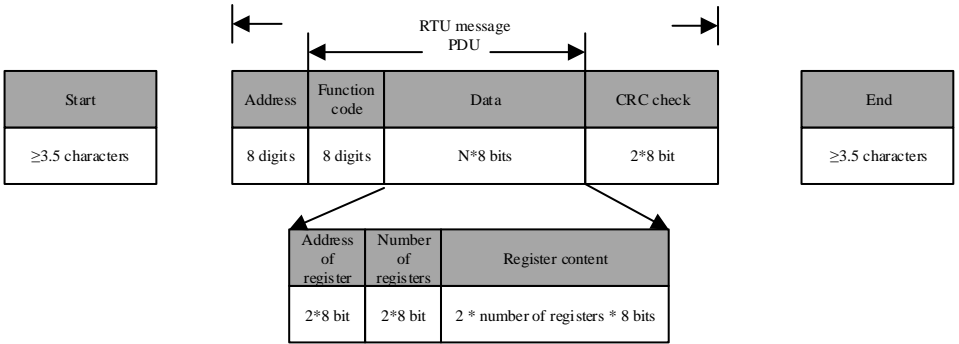

Fig. 12-20 Schematic Diagram of Message Frame in RTU Mode

The RTU message includes the address code, PDU (Protocol Data Unit) and CRC^[3] check. The PDU includes the function code and data part (mainly including the register address, number of registers, register content and the like; the detailed definitions of function codes are different, as shown in 11.3.3Function code).

[3]: the low byte of CRC check is in front of the high byte.

11.3.2 Address code

Address Range	Purpose
1 - 247	Slave
0	Broadcast

11.3.3 Function code

The classification of MODBUS function codes is shown in Fig. 12-21.

127 (0x7F)	Common function code
110 (0x6E)	User-defined function code
100 (0x64)	Common function code
72 (0x48)	User-defined function code
65 (0x41)	Common function code
1 (0x1)	Common function code

Fig. 12-21 Classification of MODBUS Function Codes

As shown in Table 12-30, EM730/EM730E series products mainly involve **common function codes**. For example, 0x03: function code used to read multiple registers or status words, **0x06**: function code used to write a single register or command, 0x10: function code used to write multiple registers or commands, and 0x08: function code for diagnosis.

In addition, for some specific functions, such as register writing (RAM) without EEPROM storage, the **user-defined function codes** include 0x41: function code used to write a single register or command (without saving), and 0x42: function code used to write multiple registers or commands (without saving).

When the abnormal valid data is received from a device, a related abnormality message will be returned (see 11.3.7Exception **response**). The abnormality function code is defined to distinguish the abnormal data from normal communication data. Corresponding to the normal request function code, the **abnormality function code = request function code + 0x80**.

Table 12-30 Function Code Definitions of EM730/EM730E series Product

Function code	Abnormality function code	Function
03	83	This function code is used to read multiple registers or status words.
41	C1	This function code is used to write a single register or command without saving.
42	C2	This function code is used to write multiple registers or commands without saving.
08	88	This function code is used for diagnosis.
06	86	This function code is used to write a single register or command.
10	90	This function code is used to write multiple registers or commands.

PDU parts are detailed in the following sections, depending on various functions.

1.1.1.1 0x03: function code used to read multiple registers or status words

In the remote terminal unit, this function code is used to read the content in the continuous block of the holding register. The request PDU describes the starting register address and the number of registers.

The register data in the response message is divided into two bytes in each register. The first byte of each register includes high-order bits and the second byte includes low-order bits.

● Request PDU

Function code	1 byte	0x03
Starting Address	2 bytes	0x0000 - 0xFFFF
Number of registers	2 bytes	1 - 16

● Response PDU

Function code	1 byte	0x03
Number of bytes	1 byte	2×N*
Register value	N*×2 bytes	

N* = number of registers

● Error PDU

Error code	1 byte	0x83
Exception code	1 byte	01, 02, 03 or 04

Below is an example of a request to read the registers F19.00 to F19.05 (relevant information about the last protection):

Request		Respond			
Domain name	(0x)	Domain name (normal)	(0x)	Domain name (abnormal)	(0x)
Function code	03	Function code	03	Function	83
Starting address Hi	13	Number of bytes	0C	Exception code	03 (example, the same below)
Starting address Lo	00	Register value Hi (F19.00)	00		
Number (Hi) of registers	00	Register value Lo (F19.00)	11		
Number (Lo) of registers	06	Register value Hi (F19.01)	00		
		Register value Lo (F19.01)	00		
		Register value Hi (F19.02)	00		
		Register value Lo (F19.02)	00		

	Register value Hi (F19.03)	01	
	Register value Lo (F19.03)	2C	
	Register value Hi (F19.04)	00	
	Register value Lo (F19.04)	00	
	Register value Hi (F19.05)	00	
	Register value Lo (F19.05)	00	

According to the returned data, the “17 (0011H): temperature sensor abnormality protection” of the inverter is enabled, in which the output frequency is 0.00Hz, the output current is 0.00A, the bus voltage is 300V (012CH), the acceleration and deceleration status is “standby”, and the working time is 0 hour.

★: At present, the function code 0x03 of MODBUS protocol supports the reading of multiple function codes across groups. However, it is recommended not to read them across groups in the case of no special requirements, so the customer’s software does not need to be upgraded after our products are upgraded.

1.1.1.2 0x41: function code used to write a single register or command (without saving)

In the remote terminal unit, this function code is used to write a single non-holding register.

The request PDU describes the address to be written to the register.

The normal response is the response made to the request, which is returned after the register content is written.

● Request PDU

Function code	1 byte	0x41
Address of register	2 bytes	0x0000 - 0xFFFF
Register value	2 bytes	0x0000 - 0xFFFF

● Response PDU

Function code	1 byte	0x41
Address of register	2 bytes	0x0000 - 0xFFFF
Register value	2 bytes	0x0000 - 0xFFFF

● Error PDU

Error code	1 byte	0xC1
Exception code	1 byte	See Table 4-33

Below is an example of a request to change the main frequency source A (7001H) to “-50.00%”:

Request		Respond			
Domain name	(0x)	Domain name (normal)	(0x)	Domain name (abnormal)	(0x)
Function	41	Function	41	Function	C1
Register address Hi	70	Register address Hi	70	Exception code	03
Register address Lo	01	Register address Lo	01		
Register value Hi	EC	Register value Hi	EC		
Register value Lo	78	Register value Lo	78		

★ This function code cannot be used to change the parameters of the attribute “○” (it cannot be changed during operation). That is, only the parameters of the attribute “●” (it can be changed during operation) can be changed. Otherwise, the error code 1 will be returned.

1.1.1.3 0x42: function code used to write multiple registers or commands (without saving)

In the remote terminal unit, this function code is used to write consecutive non-holding register blocks (1 to 16 registers).

The value requested to be written is described in the request data field. The data of each register is divided into two bytes.

In the normal response, the function code, starting address and number of registers written will be returned.

● Request PDU

Function code	1 byte	0x42
Starting Address	2 bytes	0x0000 - 0xFFFF
Number of registers	2 bytes	1 - 16
Number of bytes	1 byte	2×N*
Register value	N*×2 bytes	

N* = number of registers

● Response PDU

Function code	1 byte	0x42
Starting Address	2 bytes	0x0000 - 0xFFFF
Number of registers	2 bytes	1 - 16

● Error PDU

Error code	1 byte	0xC2
Exception code	1 byte	See Table 4-33

Below is an example of a request to set the acceleration time 1 (F00.14) to 5.00 and deceleration time 1 (F00.15) to 6.00:

Request		Respond			
Domain name	(0x)	Domain name (normal)	(0x)	Domain name (abnormal)	(0x)
Function	42	Function	42	Function	C2
Starting address Hi	00	Starting address Hi	00	Exception code	03
Starting address Lo	0E	Starting address Lo	0E		
Number (Hi) of registers	00	Number (Hi) of registers	00		
Number (Lo) of registers	02	Number (Lo) of registers	02		
Number of bytes	04				
Register value Hi (F00.14)	01				
Register value Lo (F00.14)	F4				
Register value Hi (F00.15)	02				
Register value Lo (F00.15)	58				

★ This function code cannot be used to change the parameters of the attribute “○” (it cannot be changed during operation). That is, only the parameters of the attribute “●” (it can be changed during operation) can be changed. Otherwise, the error code 1 will be returned.

1.1.1.4 0x08: function code for diagnosis

The Modbus function code 08 involves a series of tests to check the communication system between the client (master station) and server (slave station), or internal error statuses of the server.

The test to be executed is defined by the sub-function code fields of two bytes in the request. The server makes responses properly.

Copy the function codes and sub-function codes. Some diagnoses will enable the remote terminal unit to return the corresponding data through the data field in normal response.

Under normal circumstances, when the diagnosis function is sent to the remote terminal unit, the user program in this remote terminal unit will not be affected. The user logic cannot be accessed by diagnosis, such as: discrete magnitude and register. The error counter in the remote terminal unit can be remotely reset by applying some functions.

The main diagnosis function used by our company is line diagnosis (0000), which is used to test the normal communication between the host and slave. The normal response to a request to return query data is to return the same data. At the same time, the function codes and sub-function codes are also copied.

● Request PDU

Function code	1 byte	0x08
Sub-function code	2 bytes	0x0000 - 0xFFFF
Data	2 bytes	0x0000 - 0xFFFF

● Response PDU

Function code	1 byte	0x08
Sub-function code	2 bytes	0x0000 - 0xFFFF
Data	2 bytes	0x0000 - 0xFFFF

● Error PDU

Error code	1 byte	0x88
Exception code	1 byte	See Table 4-33

● Sub-function code

Sub-function	Meaning	Data field (request)	Data field (response)
0000	Return query data	Any	Copy request data
...			

0000: return the data transferred in the request data field in the response. All messages should be consistent with the request message.

The following table is an example of requesting the remote terminal unit to return query data. The sub-function code 0000 is used. The returned data is sent in the two-byte data field (0xA537).

Request		Respond			
Domain name	(0x)	Domain name (normal)	(0x)	Domain name (abnormal)	(0x)
Function	08	Function	08	Function	88
Sub-function code Hi	00	Sub-function code Hi	00	Exception code	03
Sub-function code Lo	00	Sub-function code Lo	00		
Data Hi	A5	Data Hi	A5		
Data Lo	37	Data Lo	37		

1.1.1.5 0x06: function code used to write a single register or command

In the remote terminal unit, this function code is used to write a single holding register.

The request PDU describes the address to be written to the register.

The normal response is the response made to the request, which is returned after the register content is written.

● Request PDU

Function code	1 byte	0x06
Address of register	2 bytes	0x0000 - 0xFFFF
Register value	2 bytes	0x0000 - 0xFFFF

● Response PDU

Function code	1 byte	0x06
Address of register	2 bytes	0x0000 - 0xFFFF
Register value	2 bytes	0x0000 - 0xFFFF

● Error PDU

Error code	1 byte	0x86
Exception code	1 byte	See Table 4-33

Below is an example of a request to change the drive control mode of the motor 1 (F00.01) to “1: SVC”.

Request		Respond			
Domain name	(0x)	Domain name (normal)	(0x)	Domain name (abnormal)	(0x)
Function	06	Function	06	Function	86
Register address Hi	00	Register address Hi	00	Exception code	03
Register address Lo	01	Register address Lo	01		
Register value Hi	00	Register value Hi	00		
Register value Lo	01	Register value Lo	01		

★ The function code 0x06 cannot be used if modified frequently, in order to avoid damage to the inverter.

The user-defined function code 0x41 “change without saving” corresponds to the standard common function code 0x06. Its definition is the same as that of the corresponding standard function code (the same request, response and error PDU). The difference is that when the slave responds to this user-defined function code, the corresponding value of RAM is changed only and not stored in EEPROM (holding register).

For the function codes (e.g. F00.07) that are often modified, it is recommended to use the function code 0x41 (you can change the main frequency source A by directly setting 7001H, as detailed in 1.1.1.2 and 11.3.4), to avoid damage to the inverter. The specific operation is as follows.

Request		Respond	
Domain name	(0x)	Domain name (normal)	(0x)
Function	41	Function	41
Register address Hi	00	Register address Hi	00
Register address Lo	07	Register address Lo	07
Register value Hi	13	Register value Hi	13
Register value Lo	88	Register value Lo	88

Once the set frequency (F00.07) is set to 50.00Hz, the above data will be valid but not be stored in EEPROM. That is, the inverter will run at 50.00Hz after change but at the frequency before change if powered on again.

1.1.1.6 0x10: function code used to write multiple registers or commands

In the remote terminal unit, this function code is used to write consecutive register blocks (1 to 16 registers).

The value requested to be written is described in the request data field. The data of each register is divided into two bytes.

In the normal response, the function code, starting address and number of registers written will be returned.

● Request PDU

Function code	1 byte	0x10
Starting Address	2 bytes	0x0000 - 0xFFFF
Number of registers	2 bytes	1 - 16
Number of bytes	1 byte	2×N*
Register value	N*×2 bytes	

N* = number of registers

● Response PDU

Function code	1 byte	0x10
Starting Address	2 bytes	0x0000 - 0xFFFF
Number of registers	2 bytes	1 - 16

● Error PDU

Error code	1 byte	0x90
Exception code	1 byte	SeeTable 4-33

Below is an example of a request to write 00 1 and 00 3 into two registers starting from F03.00 (i.e. setting the Y1 and Y2 output terminal function):

Request		Respond			
Domain name	(0x)	Domain name (normal)	(0x)	Domain name (abnormal)	(0x)
Function	10	Function	10	Function	90
Starting address Hi	03	Starting address Hi	03	Exception code	03

Starting address Lo	00	Starting address Lo	00		
Number (Hi) of registers	00	Number (Hi) of registers	00		
Number (Lo) of registers	02	Number (Lo) of registers	02		
Number of bytes	04				
Register value Hi (F03.00)	00				
Register value Lo (F03.00)	01				
Register value Hi (F03.01)	00				
Register value Lo (F03.01)	03				

★ The function code 0x10 cannot be used if modified frequently, in order to avoid damage to the inverter, as detailed in 1.1.1.5.

11.3.4 Register address distribution

Table 12-31 Detailed Definition of Register Address of MODBUS Protocol

Address Space		Note	
Function code 0000H - 6F63H		For the function code FXX.YY, the high order is hexadecimal of XX and the low order is hexadecimal of YY. For example, the address of F00.14 is 000EH (00D=00H, 14D=0EH).	
Function code (not saved after power-down) 8000H-EF63H		When the parameters are set with the function code 0x06 or 0x10, the function that “the settings are valid immediately and not saved after power-down” can be realized in the form of “original address +8000H”. For example, the corresponding address of F00.14 is 800EH (=000EH+8000H).	
Control command (write only) 7000H ~ 71FFH	7000H control word	0000H	Invalid command
		0001H	Forward running
		0002H	Reverse running
		0003H	JOG forward
		0004H	JOG reverse
		0005H	Deceleration to stop
		0006H	Stop the controller quickly
		0007H	Free stop
		0008H	Reset protection
		0009H	+/- input switching
	000BH	JOG stop	

	Others to 00FFH	Reserved
7001H	Communication percentage setting of main channel frequency A	-100.00% to 100.00% (100% = maximum frequency)
7002H	Communication percentage setting of auxiliary channel frequency B	-100.00% to 100.00% (100% = maximum frequency)
7003H	Torque communication setting	-200.00% to 200.00% (100% = digital torque setting)
7004H	Communication setting of process PID setting	-100.00% - 100.00%
7005H	Communication setting of process PID feedback	-100.00% - 100.00%
7006H	Voltage setting of VF separation mode	0.00% to 100.00% (digital setting reference)
7007H to 7009H	Reserved	
700AH	Communication percentage setting of upper frequency limit	0.00% to 200.00% (digital setting reference)
700BH	Communication percentage setting of upper frequency limit of torque control	0.00% to 200.00% (digital setting reference)
700CH	Linear speed input for inertia compensation	0.00% to 100.00% (digital setting reference)
700DH to 700EH	Reserved	
700FH	Master-slave communication setting	-100.00%to 100.00% (maximum reference)
7010H to 7013H	Reserved	
7014H	External	Protection input of external device

		protection	(including option card)	
	7015H	Communication setting of main channel frequency A	0.00 to maximum frequency	
	7016H	Communication setting of auxiliary channel frequency B	0.00 to maximum frequency	
	7017H	Communication setting of upper frequency limit	0.00 to maximum frequency	
	7018H	Communication setting of upper frequency limit of torque control	0.00 to maximum frequency	
	7019H	Communication setting of upper torque limit of speed control	0.0 to 250.0% (based on 100.0% or direct sending)	
	701AH	Communication setting 1	Communication setting by M1 terminal, communication address option 701AH	
	701CH~71FFH	Reserved		
Working status 7200H ~ 73FFH	7200H status word 1	Bit7 to 0 running status	00H	Parameter setting
			01H	Slave running
			02H	JOG running
			03H	Self-learning running
			04H	Slave stop
			05H	JOG stop
			06H	Protection status
			07H	Factory self-inspection
			08H - 0FFH	Reserved
	7201H status word 2	Bit15-8 protection information	00H	Normal running of inverter
			xxH	Inverter protection status, where "xx" is the protection code
	Bit0 setting direction	1	- setting is valid	
		0	+ setting is valid	
	Bit1 running direction	1	Reverse frequency output	
		0	Forward frequency output	

		Bit3 to 2 running mode	00	Speed control mode					
			01	Torque control mode					
			10	Reserved					
			11	Reserved					
		Bit4 parameter protection	1	Valid parameter protection					
			0	Invalid parameter protection					
		Bit6 - 5	Reserved						
		Bit8 to 7 setting mode	00	Keyboard control					
			01	Terminal control					
			10	Communication control					
	11		Reserved						
	Bit9	Reserved							
	Bit10 warning	0	No warning						
		1	Warning status (see 7230H for details)						
	Bit15 - 10	Reserved							
7202H monitoring frequency +/- status word 1 (1: -; 0: +)	Bit0	Output frequency							
	Bit1	Input frequency							
	Bit2	Synchronization frequency							
	Bit3	Reserved							
	Bit4	Estimate feedback frequency							
	Bit5	Estimated slip frequency							
	Bit6	Load rate							
	Bit15 to 7	Reserved							
7203H	Output frequency								
7204H	Output voltage								
7205H	Output power								
7206H	Running speed								
7207H	Bus voltage								
7208H	Output torque								
7209H	Digital input 1	15	14	13	12	11	10	9	8
		*	*	*	*	*	*	*	*
		7	6	5	4	3	2	1	0
720AH	Digital input 2	*	*	*	X5	X4	X3	X2	X1
		15	14	13	12	11	10	9	8
		VX8	VX7	VX6	VX5	VX4	VX3	VX2	VX1
720BH	Digital output 1	7	6	5	4	3	2	1	0
		*	*	*	*	*	*	AI2	AI1
		15	14	13	12	11	10	9	8
		*	*	*	*	*	*	*	*
							Y1	*	R1

	720CH	Digital output 2	15	14	13	12	11	10	9	8	
			VY8	VY7	VY6	VY5	VY4	VY3	VY2	VY1	
			7	6	5	4	3	2	1	0	
			*	*	*	*	*	*	*	*	
	720DH	Previous two protections									
	720EH	Previous three protections									
	720FH	Last protection									
	7210H	Output frequency of the last protection									
	7211H	Output current of the last protection									
	7212H	Bus voltage of the last protection									
	7213H	Running status of the last protection									
	7214H	Working time of the last protection									
	7215H	Set acceleration time									
	7216H	Set deceleration time									
	7217H	Cumulative length									
	7218H	Reserved									
	7219H	UP/DOWN offset frequency symbol (0/1: +/-)									
	7224H	Output current									
	7225H	Set frequency									
	7228H	Cumulative power-on time									
7230H	Warning number	0: no warning; others: current warning sign									
Other - 73FFH	Reserved										
Product information on 7500H ~ 75FFH	7500H	Performance software S/N 1			Corresponding to the function code F12.22						
	7501H	Performance software S/N2			Corresponding to the function code F12.23						
	7502H	Functional software S/N 1			Corresponding to the function code F12.24						
	7503H	Functional software S/N 2			Corresponding to the function code F12.25						
	7504H	Keyboard software serial number 1			Corresponding to the function code F12.26						
	7505H	Keyboard software serial number 2			Corresponding to the function code F12.27						
	7506H	Serial No. 1			Corresponding to the function code F12.28						
	7507H	Serial No. 2			Corresponding to the function code F12.29						
	7508H	Serial No. 3			Corresponding to the function code F12.30						
	7509H~	Reserved									

	75FFH		
Others	Reserved		

11.3.5 Definition of frame data length

The PDU part of the RTU frame of the MODBUS message is able to read/write 1-16 registers. For different function codes, the actual length of the RTU frame varies, as detailed in Table 12-32.

Table 12-32 Correspondence between RTU Frame Length and Function Code

Function code (0x)	RTU frame length (bytes)			Maximum length (Byte)
	Request	Normal response	Exception response	
03	8	$5+2N_r[4]^1$	5	37
41 (06)	8	8	5	8
08	8	8	5	8
42 (10)	$9+2N_w[5]^1$	8	5	41

[4]: $N_r \leq 16$, indicating the number of requests to read registers;

[5]: $N_w \leq 16$, indicating the number of requests to write registers.

[6]: $N_w + N_r \leq 16$;

11.3.6 CRC check

The low byte of CRC check is in front of the high byte.

The transmitter first calculates the CRC value, which is included in the sent message. Upon receiving the message, the receiver will recalculate the CRC value and compare the calculated value with the received CRC value. If the two values are not equal, it means that there is an error in the sending process.

Calculation process of CRC check:

- (1) Define a CRC register and assign an initial value, FFFFH.
- (2) Perform the XOR calculation with the first byte of the transmitted message and the value of the CRC register, and store the result in the CRC register. Starting from the address code, the start bit and stop bit are not involved in calculation.
- (3) Extract and check the LSB (the least significant bit of the CRC register).
- (4) If the LSB is 1, each bit of the CRC register is shifted to the right by one bit, and the most significant bit is supplemented by 0. Perform the XOR calculation of the value of the CRC register and A001H, and store the result in the CRC register.

- (5) If the LSB is 0, each bit of the CRC register is shifted to the right by one bit, and the most significant bit is supplemented by 0.
- (6) Repeat the steps 3, 4, and 5 until 8 shifts are completed.
- (7) Repeat the steps 2, 3, 4, 5 and 6 to process next byte of the transmitted message, until all bytes of the transmitted message are processed.
- (8) After the calculation, the content of the CRC register is the value of CRC check.
- (9) In a system with limited time resources, it is recommended to perform CRC check by the table lookup method.

The simple function of CRC is as follows (programmed in C language):

```
unsigned int CRC_Cal_Value(unsigned char *Data, unsigned char Length)
```

```
{  
    unsigned int crc_value = 0xFFFF;  
    int i = 0;  
    while(Length--)  
    {  
        crc_value ^= *Data++;  
        for(i=0;i<8;i++)  
        {  
            if(crc_value & 0x0001)  
            {  
                crc_value = (crc_value>>1)^ 0xa001;  
            }  
            else  
            {  
                crc_value = crc_value>>1;  
            }  
        }  
    }  
    return(crc_value);  
}
```

This only describes the theory of CRC check and requires a long execution time. Especially

```

0xA0,0x60,0x61,0xA1,0x63,0xA3,0xA2,0x62,0x66,0xA6,0xA7,0x67,0xA5,0x65,0x64,0xA4,
0x6C,0xAC,0xAD,0x6D,0xAF,0x6F,0x6E,0xAE,0xAA,0x6A,0x6B,0xAB,0x69,0xA9,0xA8,0x68,
0x78,0xB8,0xB9,0x79,0xBB,0x7B,0x7A,0xBA,0xBE,0x7E,0x7F,0xBF,0x7D,0xBD,0xBC,0x7C,
0xB4,0x74,0x75,0xB5,0x77,0xB7,0xB6,0x76,0x72,0xB2,0xB3,0x73,0xB1,0x71,0x70,0xB0,
0x50,0x90,0x91,0x51,0x93,0x53,0x52,0x92,0x96,0x56,0x57,0x97,0x55,0x95,0x94,0x54,
0x9C,0x5C,0x5D,0x9D,0x5F,0x9F,0x9E,0x5E,0x5A,0x9A,0x9B,0x5B,0x99,0x59,0x58,0x98,
0x88,0x48,0x49,0x89,0x4B,0x8B,0x8A,0x4A,0x4E,0x8E,0x8F,0x4F,0x8D,0x4D,0x4C,0x8C,
0x44,0x84,0x85,0x45,0x87,0x47,0x46,0x86,0x82,0x42,0x43,0x83,0x41,0x81,0x80,0x40
};

```

```

UInt16CRC(UInt8 * buffer, UInt8 crc_len)

```

```

{
    UInt8  crc_i,crc_lsb,crc_msb;
    UInt16 crc;
    crc_msb = 0xFF;
    crc_lsb = 0xFF;
    while(crc_len--)
    {
        crc_i = crc_lsb ^ *buffer;
        buffer ++;
        crc_lsb = crc_msb ^ crc_l_tab[crc_i];
        crc_msb = crc_h_tab[crc_i];
    }
    crc = crc_msb;
    crc = (crc << 8) + crc_lsb;
    return crc;
}

```

- CRC16 lookup table for the 16-bit processor: (The high byte in the final result of this program is in front. Please reverse it during sending.)

```

const UInt16 crc_table[256] = {
0x0000,0xC1C0,0x81C1,0x4001,0x01C3,0xC003,0x8002,0x41C2,0x01C6,0xC006
,0x8007,0x41C7,0x0005,0xC1C5,0x81C4,0x4004,0x01CC,0xC00C,0x800D,0x41CD
,0x000F,0xC1CF,0x81CE,0x400E,0x000A,0xC1CA,0x81CB,0x400B,0x01C9,0xC009

```



```
,0x8008,0x41C8,0x01D8,0xC018,0x8019,0x41D9,0x001B,0xC1DB,0x81DA,0x401A
,0x001E,0xC1DE,0x81DF,0x401F,0x01DD,0xC01D,0x801C,0x41DC,0x0014,0xC1D4
,0x81D5,0x4015,0x01D7,0xC017,0x8016,0x41D6,0x01D2,0xC012,0x8013,0x41D3
,0x0011,0xC1D1,0x81D0,0x4010,0x01F0,0xC030,0x8031,0x41F1,0x0033,0xC1F3
,0x81F2,0x4032,0x0036,0xC1F6,0x81F7,0x4037,0x01F5,0xC035,0x8034,0x41F4
,0x003C,0xC1FC,0x81FD,0x403D,0x01FF,0xC03F,0x803E,0x41FE,0x01FA,0xC03A
,0x803B,0x41FB,0x0039,0xC1F9,0x81F8,0x4038,0x0028,0xC1E8,0x81E9,0x4029
,0x01EB,0xC02B,0x802A,0x41EA,0x01EE,0xC02E,0x802F,0x41EF,0x002D,0xC1ED
,0x81EC,0x402C,0x01E4,0xC024,0x8025,0x41E5,0x0027,0xC1E7,0x81E6,0x4026
,0x0022,0xC1E2,0x81E3,0x4023,0x01E1,0xC021,0x8020,0x41E0,0x01A0,0xC060
,0x8061,0x41A1,0x0063,0xC1A3,0x81A2,0x4062,0x0066,0xC1A6,0x81A7,0x4067
,0x01A5,0xC065,0x8064,0x41A4,0x006C,0xC1AC,0x81AD,0x406D,0x01AF,0xC06F
,0x806E,0x41AE,0x01AA,0xC06A,0x806B,0x41AB,0x0069,0xC1A9,0x81A8,0x4068
,0x0078,0xC1B8,0x81B9,0x4079,0x01BB,0xC07B,0x807A,0x41BA,0x01BE,0xC07E
,0x807F,0x41BF,0x007D,0xC1BD,0x81BC,0x407C,0x01B4,0xC074,0x8075,0x41B5
,0x0077,0xC1B7,0x81B6,0x4076,0x0072,0xC1B2,0x81B3,0x4073,0x01B1,0xC071
,0x8070,0x41B0,0x0050,0xC190,0x8191,0x4051,0x0193,0xC053,0x8052,0x4192
,0x0196,0xC056,0x8057,0x4197,0x0055,0xC195,0x8194,0x4054,0x019C,0xC05C
,0x805D,0x419D,0x005F,0xC19F,0x819E,0x405E,0x005A,0xC19A,0x819B,0x405B
,0x0199,0xC059,0x8058,0x4198,0x0188,0xC048,0x8049,0x4189,0x004B,0xC18B
,0x818A,0x404A,0x004E,0xC18E,0x818F,0x404F,0x018D,0xC04D,0x804C,0x418C
,0x0044,0xC184,0x8185,0x4045,0x0187,0xC047,0x8046,0x4186,0x0182,0xC042
,0x8043,0x4183,0x0041,0xC181,0x8180,0x4040);
```

```
UInt16 CRC16(UInt16 *msg , UInt16 len){
```

```
    UInt16 crcL = 0xFF , crcH = 0xFF;
```

```
    UInt16 index;
```

```
    while(len--){
```

```
        index = crcL ^ *msg++;
```

```
        crcL = ((crc_table[index] & 0xFF00) >> 8) ^ (crcH);
```

```
        crcH = crc_table[index] & 0xFF;
```

```
    }
```

```
return (crcH<<8) | (crcL);
}
```

11.3.7 Exception response

When the master station sends a request to the slave station, the master station expects a normal response. Query of the master station may result in one of the following four events:

- If a request without communication error is received from the slave station and can be processed properly, a normal response will be returned by the slave station.
- If the slave station does not receive a request due to communication errors, no message will be returned. This will be regarded as a timeout by the slave station.
- If the slave station receives a request but detects a communication error (parity, address, frame error, etc.), no response will be returned. This will be regarded as a timeout by the slave station.
- If the slave station receives a request without communication error but cannot process the request (e.g. a request to read the non-existent register), the slave station will return an exception response and the master station will be informed of the actual error.

The exception response message has two fields different from those of the normal response:

- **Function code field:** In the normal response, the slave station copies the function code of the original request in the corresponding function code field. The MSB values of all function codes are 0. In the exception response, the MSB of the function code is set to 1 by the slave station. That is, **the exception response function code = normal response function code + 0x80**.
- **Data field:** The slave station can return the data from the data field in the normal response and exception code in the exception response. For the defined exception codes, Table 4-33 Definitions of Exception CodesTable 4-33.

Table 4-33 Definitions of Exception Codes

Exception code	Item	Meaning
01H	Illegal function	The function code received by the slave station (inverter) is beyond the configured range (see 11.3.3Function code).
02H	Illegal data	The data address received by the slave station (inverter) is not

	address	allowed. In particular, the combination of the start address of the register and the transmission length is invalid (see 11.3.4Register address distribution).
03H	Illegal data frame	The slave station (inverter) has detected the incorrect query data frame length or CRC check.
04H	Slave protection	When the slave station (inverter) tries to execute a requested operation, an unrecoverable error occurs. This may be caused by the logic error, failure to write to the EEPROM, etc.
05H	Data over-range	The data received by the slave station (inverter) is not between the minimum and maximum values of the corresponding register.
06H	Parameter read-only	The current register is read-only and cannot be written.
07H	Unchangeable parameter in running	When the inverter is in the running status, the current register cannot be written. If necessary, please shut down the inverter.
08H	Parameter protection by password	The current register is protected by a password.

11.4 Protocol Description

11.4.1 Definition of inter-frame and intra-frame time interval

A complete MODBUS message contains not only the necessary data units, but also the starting and ending tags. Thus, as shown in Fig. 12-20 or Fig. 4-22, the idle level with a transmission time of 3.5 characters or more is defined as the starting and ending tag. If there is an idle level with a transmission time of more than 1.5 characters during message transmission, the transmission will be deemed exceptional.

Specific starting/ending and exception intervals are related to the baud rate, as detailed in Table 4-34. If the baud rate is 9600bps and the sampling period is 1ms, the starting and ending time interval is the idle level of 4ms or more ($3.5 \times 10 / 9600 = 3.64 \approx 4$), and the exceptional data interval is the idle level in which the interval of data bits of one frame is greater than or equal to 2ms ($1.5 \times 10 / 9600 = 1.56 \approx 2$) and less than 4m (the idle level of normal data bits is less than or equal to 1ms).

Table 4-34 Correspondence between Time Interval and Baud Rate ($t_{adjust}=1ms$)

Correspondence between Time Interval and Baud Rate ($t_{adjust}=1ms$)	Starting and ending time interval $T_{interval}(t_{adjust})$	Exception interval $T_{exception}(t_{adjust})$	Remarks
4800	8	4	The idle level of 3ms or less is allowed for a normal frame. When the idle level is 8ms or greater, it indicates the end of a frame of data.
9600	4	2	The idle level of 1ms or less is allowed for a normal frame. When the idle level is 4ms or greater, it indicates the end of a frame of data.
19200	2	1	The idle level of less than 1ms is allowed for a normal frame. When the idle level is 2ms or greater, it indicates the end of a frame of data.
Higher	1	1	When an idle level of 1ms appears, it indicates the end of a frame.

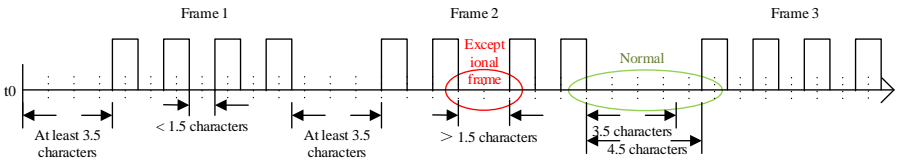

Fig. 4-22 Schematic Diagram of Normal and Exceptional Data Frames

11.4.2 Data frame processing

Upon receiving a frame data, the system will first perform preprocessing to determine whether it is a legal frame sent to this machine and check whether the data is correct, followed by final processing. If the received frame is not legal, the data will not be sent back. If the received frame is legal but incorrect, the corresponding exceptional message frame will be sent back.

Legal frame: Meet the address (local or broadcast) and length (not less than 3) requirements.

Correct frame: It is a legal frame with a correct memory address. The memory content is within the defined range and can be processed at present.

11.4.3 Response delay

The response delay (depending on the function code F10.04) is defined as the time interval from the reception of valid data frame^[7] (data in the RS-485 network, different from the command sent by the keyboard) to data parsing and return. Since the starting and ending characters are defined in the standard protocol, it is impossible to avoid response delay, at least “3.5-character time interval + 1 ms (chip stabilization time of 485 protocol, t_{wait2})”. The specific minimum time interval is related to the baud rate. If the baud rate is 9600bps, the minimum response delay is 5ms ($3.5 \times 10 / 9600 + 1 = 4.64 \approx 5$).

If the communication data involves EEPROM operation, the time interval will be longer.

[7]: Valid data frame: Sent by the external master station (not keyboard) to this machine. The function code, length and CRC of the data are correct. Fig. 4-23 shows the data sending segment (t_{send}), sending end segment (t_{wait1}), 75176-to-sending wait segment (t_{wait2}), data return segment (t_{return}), and 75176-to-receiving wait segment (t_{wait3}).

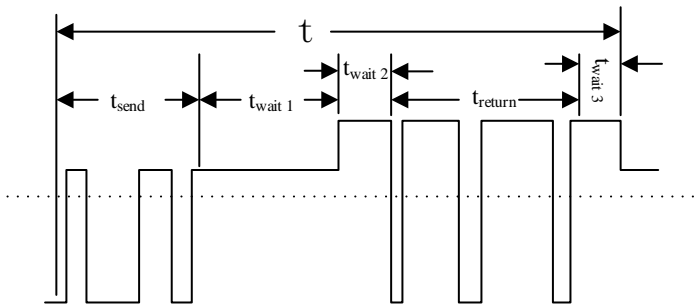

Fig. 4-23 Timing Parse Diagram of Complete Data Frame

11.4.4 Communication timeout

The communication time interval Δt is defined as the period from the previous reception of valid data frames by the slave station (inverter) to next reception of valid data frames. If Δt is greater than the set time (depending on the function code F10.03; this function is invalid if set to 0), it will be regarded communication timeout.

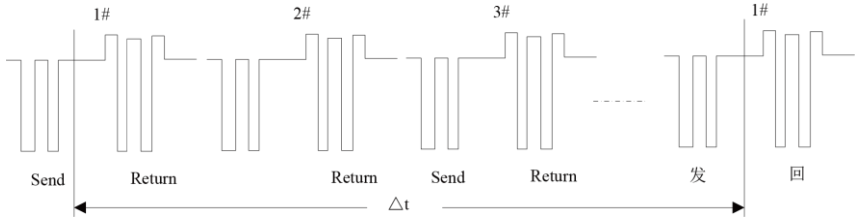

Fig. 4-24 485 Schematic Diagram of Network Link Data

11.5 Examples

1) Forward running of inverter

Send: 01 41 70 0000 01 E6 C5

Return: 01 41 70 0000 01 E6 C5 (normal)

Return: 01 C1 04 70 53 (exception, assuming a slave protection)

	Send the invoice to		Normal Return		Exception Return	
* Frame header						≥3.5 characters (idle)
1 Address	01	Address	01	Address	01	
2 Function code	41	Function code	41	Function code	C1	
3 Register address Hi	70	Register address Hi	70	Exception code	04 (assumption)	
4 Register address Lo	00	Register address Lo	00	CRC check Lo	70	
5 Register value Hi	00	Register value Hi	00	CRC check Hi	53	
6 Register value Lo	01	Register value Lo	01			
7 CRC check Lo	E6	CRC check Lo	E6			
8 CRC check Hi	C5	CRC check Hi	C5			
* Tail						≥3.5 characters (idle)

2) Free stop of inverter

Send: 01 41 70 0000 07 66 C7

Return: 01 41 70 0000 07 66 C7 (normal)

Return: 01 C1 04 70 53 (exception, assuming a slave protection)

	Send the invoice to		Normal Return		Exception Return	
* Frame header						≥3.5 characters (idle)
1 Address	01	Address	01	Address	01	
2 Function code	41	Function code	41	Function code	C1	
3 Register address Hi	70	Register address Hi	70	Exception code	04 (assumption)	
4 Register address Lo	00	Register address Lo	00	CRC check Lo	70	
5 Register value Hi	00	Register value Hi	00	CRC check Hi	53	
6 Register value Lo	07	Register value Lo	07			

7	CRC check Lo	66	CRC check Lo	66	
8	CRC check Hi	C7	CRC check Hi	C7	
*	Tail	≥3.5 characters (idle)			

3) Command word for change of set frequency (e.g. 50.00Hz/1388H) (F00.04=7)

Send: **01 41 70 15 13 88 3B 97**

Return: 01 41 70 15 13 88 3B 97 (normal)

Return: 01 C1 04 70 53 (exception, assuming a slave protection)

Send the invoice to		Normal Return		Exception Return	
*	Frame header	≥3.5 characters (idle)			
1	Address	01	Address	01	Address
2	Function code	41	Function code	41	Function code
3	Register address Hi	70	Register address Hi	70	Exception code
4	Register address Lo	15	Register address Lo	15	CRC check Lo
5	Register value Hi	13	Register value Hi	13	CRC check Hi
6	Register value Lo	88	Register value Lo	88	
7	CRC check Lo	3B	CRC check Lo	3B	
8	CRC check Hi	97	CRC check Hi	97	
*	Tail	≥3.5 characters (idle)			

1) Read the information of last protection (read the function codes F19.00-F19.05)

Send: **01 03 13 00 00 06 C1 4C**

Return: 01 03 0C 00 11 00 00 00 00 01 2C 00 00 00 0053 5B (normal)

Return: 01 83 04 40 F3 (exception, assuming a slave protection)

Send the invoice to		Normal Return		Exception Return	
*	Frame header	≥3.5 characters (idle)			
1	Address	01	Address	01	Address
2	Function code	03	Function code	03	Function code
3	Starting address Hi	13	Number of bytes	0C	Exception code
4	Starting address Lo	00	Register value Hi (F19.00)	00	CRC check Lo
5	Number (Hi) of registers	00	Register value Lo (F19.00)	11	CRC check Hi
6	Number (Lo) of registers	06	Register value Hi (F19.01)	00	
7	CRC check Lo	C	Register value Lo (F19.01)	00	
8	CRC check Hi	4	Register value Hi (F19.02)	00	
9			Register value Lo (F19.02)	00	

10		Register value Hi (F19.03)	01	
11		Register value Lo (F19.03)	2C	
12		Register value Hi (F19.04)	00	
13		Register value Lo (F19.04)	00	
14		Register value Hi (F19.05)	00	
15		Register value Lo (F19.05)	00	
16		CRC check Lo	53	
17		CRC check Hi	5B	
*	Tail	≥3.5 characters (idle)		

2) Check whether the line is connected.

Send: **01 08 00 00 AA 55 5E 94**

Return: **01 08 00 00 AA 55 5E 94 (normal)**

Return: **01 88 04 47 C3 (exception, assuming a slave protection)**

	Send the invoice to	Normal Return		Exception Return	
*	Frame header	≥3.5 characters (idle)			
1	Address	01	Address	01	Address
2	Function	08	Function	08	Function code
3	Sub-function code Hi	00	Sub-function code Hi	00	Exception code
4	Sub-function code Lo	00	Sub-function code Lo	00	CRC check Lo
5	Data Hi	AA	Data Hi	AA	CRC check Hi
6	Data Lo	55	Data Lo	55	
7	CRC check Lo	5E	CRC check Lo	5E	
8	CRC check Hi	94	CRC check Hi	94	
*	Tail	≥3.5 characters (idle)			

3) Change the carrier frequency (F00.23) to 4.0kHz. (use the function code 0x06 as such function codes are expected to be stored in EEPROM after change)

Send: **01 06 00 17 00 28 39 D0**

Return: **01 06 00 17 00 28 39 D0 (normal)**

Return: **01 86 04 43 A3 (exception, assuming a slave protection)**

	Send the invoice to	Normal Return		Exception Return	
*	Frame header	≥3.5 characters (idle)			
1	Address	01	Address	01	Address
2	Function code	06	Function code	06	Function code
3	Register address Hi	00	Register address Hi	00	Exception code
4	Register address Lo	17	Register address Lo	17	CRC check Lo
5	Register value Hi	00	Register value Hi	00	CRC check Hi
6	Register value Lo	28	Register value Lo	28	
7	CRC check Lo	39	CRC check Lo	39	

8	CRC check Hi	D0	CRC check Hi	D0	
*	Tail	≥3.5 characters (idle)			